

**WISENET**

# **CÁMARA DE RED**

Manual del usuario

XNP-6371RH



# Cámara de Red

## Manual del usuario

---

### Copyright

©2019 Hanwha Techwin Co., Ltd. Reservados todos los derechos.

### Marca comercial

Todas las marcas aquí mencionadas están registradas. El nombre de este producto y otras marcas mencionadas en este manual son marcas registradas de sus respectivas compañías.

### Restricción

Reservados los derechos de autor de este documento. Este documento no se deberá reproducir, distribuir ni cambiar, de modo total o parcial, bajo ninguna circunstancia, sin autorización formal.

### Renuncia

Hanwha Techwin hace lo máximo por verificar la integridad y exactitud del contenido de este documento, pero no se proporciona ninguna garantía formal. El uso de este documento y los resultados posteriores será total responsabilidad del propio usuario. Hanwha Techwin se reserva el derecho a cambiar el contenido de este documento sin aviso previo.

❖ El diseño y las especificaciones están sujetos a cambio sin aviso.

❖ El ID inicial del administrador es "admin" y la contraseña debe establecerse al iniciar sesión por primera vez. Por favor, cambie su contraseña cada tres meses para proteger de forma segura la información personal y evitar daños por el robo de información. Por favor, tenga en cuenta que es responsabilidad del usuario la seguridad y otros problemas causados por el mal manejo de una contraseña.

## INSTRUCCIONES DE SEGURIDAD IMPORTANTES

1. Lea estas instrucciones.
2. Consérvelas.
3. Atente para todas las advertencias.
4. Siga todas las instrucciones.
5. No utilice este aparato cerca del agua.
6. Limpie el área contaminada en la superficie del producto con un paño seco y suave o un paño húmedo. (No utilice detergente o productos cosméticos que contengan alcohol, disolventes o tensioactivos o constituyentes de aceites, ya que pueden deformar o dañar el producto).
7. No obstruya ninguna apertura de ventilación. Instale el aparato siguiendo las instrucciones del fabricante.
8. No lo instale cerca de ninguna fuente de calor como radiadores, focos de calor o cualquier otro aparato (incluidos los amplificadores) que emita calor.
9. No olvide que la finalidad de los enchufes polarizados o de toma a tierra es proporcionarle seguridad. Un enchufe polarizado tiene dos clavijas, una más ancha que la otra. Un enchufe con toma a tierra tiene dos clavijas y una tercera de toma a tierra. Tanto la clavija más ancha, en el caso del enchufe polarizado, como la clavija adicional, en el caso del enchufe con toma a tierra, tienen como objetivo aportar seguridad. Si el enchufe del aparato no encaja en su toma de corriente, póngase en contacto con un electricista para cambiar la toma de corriente obsoleta.
10. Evite pisar o doblar el cable de alimentación. Ponga especial cuidado para no hacerlo en enchufes, tomas de corriente y en los puntos en los que salen desde el aparato.
11. Utilice únicamente los dispositivos y accesorios especificados por el fabricante.
12. Utilice sólo las mesitas con ruedas, soportes, trípodes o mesas recomendadas por el fabricante o vendidas con el aparato. Cuando se utilice una mesita con ruedas, tenga cuidado al mover la mesita con ruedas junto con el aparato para evitar daños por vuelco.
13. Desenchufe este aparato durante tormentas eléctricas o cuando no se utilice durante largos períodos de tiempo.
14. Remita todas las reparaciones a personal de mantenimiento cualificado. Es necesario enviar el aparato para su reparación cuando ha sufrido cualquier tipo de daño, como, por ejemplo, que el cable o el enchufe de la alimentación está dañado, se han derramado líquidos sobre el aparato o algún objeto ha caído sobre él, el aparato ha sido expuesto a la lluvia o a humedad, no funciona correctamente o se ha caído al suelo.
15. Este producto se ha diseñado para alimentarse mediante una unidad de alimentación con marca "Clase 2" o "LPS" y con capacidad nominal de 24 VCA (50/60 Hz), mín. 4.2 A.
16. Si utiliza una fuerza excesiva al instalar el producto, es posible que la cámara pueda sufrir daños y funcione de forma incorrecta.  
Si instala el producto de forma forzada utilizando herramientas no compatibles, es posible que el producto pueda sufrir daños.
17. No instale el producto en un lugar donde exista o pueda generarse sustancias químicas o niebla de aceite. Los aceites comestibles como el aceite de soja pueden dañar o deformar el producto, por lo que no debe instalar el producto en la cocina o cerca de la mesa de la cocina. Esto podría causar daños al producto.
18. Al instalar el producto, tenga cuidado y no permita que la superficie del producto se manche con sustancias químicas. Algunos disolventes químicos como limpiadores o adhesivos pueden causar daños graves a la superficie del producto.
19. Si instala o desmonta el producto de una manera que no se ha recomendado, es posible que las funciones/ rendimiento de producción no estén garantizados.  
Instale el producto consultando "Instalación y conexión" en el manual del usuario.
20. La instalación o uso del producto en el agua puede causar daños graves al producto.



## ADVERTENCIA



PARA REDUCIR EL RIESGO DE INCENDIO O DESCARGA ELÉCTRICA, MANTENGA ESTE DISPOSITIVO LEJOS DE LLUVIA Y/O LA HUMEDAD. NO INSERTE NINGÚN OBJETO METÁLICO EN LAS REJILLAS DE VENTILACIÓN NI EN NINGUNA ABERTURA DEL EQUIPO.

No debe exponer el aparato a gotas ni salpicaduras de agua ni a objetos con líquido, como jarrones, evitando colocarlos sobre el aparato.

Para evitar daños, este aparato debe instalarse de forma adecuada en el techo o la pared de acuerdo con las instrucciones de instalación.

**Los motores con bandeja/volante/zoom y el anillo colector tienen garantía por un año bajo un funcionamiento continuo.**

## PRECAUCIÓN

	<b>PRECAUCIÓN</b> NO ABRIR RIESGO DE SUFRIR UNA DESCARGA ELÉCTRICA	
<b>PRECAUCIÓN : PARA REDUCIR EL RIESGO DE SUFRIR UNA DESCARGA ELÉCTRICA, NO RETIRE LA CUBIERTA (NI LA PARTE POSTERIOR). DENTRO NO HAY PIEZAS QUE PUEDAN SER REPARADAS POR EL USUARIO. REMITA EL APARATO A PERSONAL DE MANTENIMIENTO CUALIFICADO.</b>		

## EXPLICACIÓN DE LOS SÍMBOLOS GRÁFICOS



Un triángulo con un rayo y una punta de flecha es un símbolo de advertencia para avisar al usuario de la presencia de "voltajes peligrosos" dentro de la carcasa del producto que pueden ser lo suficientemente intensas como para constituir un peligro de descarga eléctrica.



Un triángulo con un signo de exclamación es un símbolo de advertencia para avisar al usuario de que hay instrucciones importantes de funcionamiento y mantenimiento (reparaciones) en la documentación que acompaña al aparato.

## Construcción de clase I

Un aparato con construcción de CLASE I se conectará a una toma de corriente con la conexión de protección de tierra.

## Batería

No debe exponer las baterías (paquete de batería o pilas instalados) a calor excesivo, a la luz directa del sol ni al fuego, etc.

No es posible sustituir la batería.

## Desconexión del dispositivo

Desconecte el enchufe de corriente del aparato si está defectuoso. Y llame a un servicio de reparaciones.

**Cuando lo utilice fuera de EE.UU., se puede utilizar el código HAR con acoplamiento de una agencia aprobada.**

## PRECAUCIÓN

Estas instrucciones de servicio están destinadas únicamente a personal de servicio técnico cualificado.

Para reducir el riesgo de descarga eléctrica no realice ninguna operación de servicio que no sean las indicadas en las instrucciones de funcionamiento a menos que esté cualificado para hacerlo.

Se suministra el terminal de salida CVBS del producto para facilitar la instalación, aunque no se recomienda utilizarlo con fines de gestión.

Utilice la alimentación de entrada con sólo una cámara y sin que estén conectados otros dispositivos.

**El ITE solo se debe conectar a redes PoE sin enviarlo a la red externa.**

Lea detenidamente las precauciones de seguridad recomendadas que se incluyen a continuación.

- No coloque este aparato sobre una superficie desigual.
- No lo instale en una superficie expuesta a la luz directa del sol, cerca de equipos de calefacción ni cerca de áreas frías.
- No coloque este aparato cerca de material conductivo.
- No intente reparar este aparato por sí solo.
- No coloque jarrones sobre el producto.
- No lo instale cerca de fuentes magnéticas.
- No bloquee las aberturas de ventilación.
- No coloque objetos pesados sobre el producto.
- Use guantes protectores cuando instale/desinstale la cámara.  
La alta temperatura de la superficie del producto puede causar quemaduras.

El Manual del usuario es una guía sobre cómo utilizar los productos.

El significado de los signos que se utilizan en el manual es el siguiente.

- Referencia : en caso de que se facilite información de ayuda sobre el uso del producto
- Aviso : si existe alguna posibilidad de que se produzcan daños en bienes o lesiones en personas causadas por no seguir las instrucciones
- ✘ Lea este manual por razones de seguridad antes de utilizar los productos y guárdelo en un lugar seguro.

## ÍNDICE GENERAL

<b>DESCRIPCIÓN</b>	3	Instrucciones de Seguridad Importantes	<b>WEB VIEWER</b>	21	Conexión a la Cámara
	6	Características Recomendadas del Ordenador		22	Configuración de contraseña
<b>3</b>	6	Especificaciones de la Tarjeta de Memoria SD/SDHC/SDXC Recomendada	<b>21</b>	22	Inicio de Sesión
	6	Especificaciones recomendadas para NAS		22	Especificaciones de compatibilidad del plug-in para cada navegador
	6	Componentes		23	Instalación del Plugin WebViewer
	7	Vista		23	Uso del visor web sin plug-in
				23	Configuración del visor web de la cámara
<b>INSTALACIÓN Y CONEXIÓN</b>	9	Conexión con otros Dispositivos	<b>APÉNDICE</b>	24	Ajuste del Conmutador DIP
	10	Instalación		24	Cables de la cámara
<b>9</b>	14	Insertar/Eliminar una Tarjeta de Memoria SD	<b>24</b>	25	Especificaciones
				27	Vista del Producto
<b>CONEXIÓN Y CONFIGURACIÓN DE LA RED</b>	15	Conectar la Cámara Directamente a la Red de Área Local		28	Solución de Problemas
	15	Conexión Directa de la Cámara a un Módem DSL/Cable Basado en DHCP		29	Open Source Announcement
<b>15</b>	16	Conexión de la Cámara Directamente al Módem PPPoE			
	16	Conectar la Cámara a un Enrutador de Banda Ancha con el Módem PPPoE/Cable			
	17	Cómo usar el Device Manager			
	17	Búsqueda automática de la cámara			
	17	Cómo configurar la dirección IP			
	18	Cómo registrar la cámara manualmente			
	18	Configuración automática de la IP			
	19	Configuración de Reenvío del Rango de Puertos (Asignación de Puertos)			
	20	Conexión a la Cámara desde un PC local Compartido			
	20	Conexión a la Cámara desde un PC remoto a Través de Internet			

## CARACTERÍSTICAS RECOMENDADAS DEL ORDENADOR

- CPU : Intel(R) Core(TM) i7 a 3,4 GHz o superior
  - RAM: 8G o más
  - SO admitido : MS Windows, Mac OS X
  - **Visor web sin plug-in**  
Navegadores web compatibles: Google Chrome, MS Edge, Mozilla Firefox (Windows solo de 64 bit), Safari de Apple (solo Mac OS X)
  - **Visor web de plug-in**  
Navegadores web compatibles: MS Explorer, Apple Safari (solo Mac OS X)
- Consulte el apéndice para obtener información detallada de la versión en el OS verificado y las versiones del navegador.

## ESPECIFICACIONES DE LA TARJETA DE MEMORIA SD/SDHC/SDXC RECOMENDADA

- Capacidad recomendada : 4GB ~ 128GB (El sistema de archivos ext4 se recomienda para las tarjetas de memoria SD de 128 GB.)
- Para su cámara, le recomendamos utilizar una tarjeta de memoria de los siguientes fabricantes:  
Tarjeta de memoria SD/SDHC/SDXC (tipo MLC) : Sandisk, Transcend
- Para framerates inferiores a 30 fps, se recomienda utilizar una tarjeta de memoria de Clase 6 o superior.
- Para framerates inferiores a 31 fps, se recomienda utilizar una tarjeta de memoria de Clase 10 o superior.

## ESPECIFICACIONES RECOMENDADAS PARA NAS

- Capacidad recomendada : Se recomienda que sea de 200 GB o superior.
- Acceso simultáneo : Una unidad de NAS puede aceptar un máximo de accesos simultáneos de hasta dieciséis cámaras.
- Para esta cámara, se recomienda utilizar una unidad NAS con las siguientes especificaciones del fabricante.

Productos recomendados	Tamaños disponibles
QNAP NAS	Accesos simultáneos para un máximo de 16 cámaras.
NAS Synology	Accesos simultáneos para un máximo de 16 cámaras.



- El número de accesos a cámaras se reducirá si utiliza la unidad NAS para otros fines que no sean el de almacenamiento de vídeo.

## COMPONENTES

Compruebe si la cámara y los accesorios se incluyen en el paquete del producto.  
(Debido a los diferentes países de venta, los accesorios no son los mismos.)

Aspecto	Nombre de elemento	Cantidad	Descripción
	Cuerpo principal	1	
	Manual de consulta rápida (Opcional)	1	
	Tarjeta de garantía (Opcional)	1	
	Cable para probar el monitor	1	Se utiliza para probar la conexión de la cámara en un dispositivo de visualización portátil
	Tornillo hexagonal	3	Se utiliza para acoplar la base de instalación a la cámara
	Llave en L	1	Se utiliza para fijar la base de instalación tras acoplarla en la cámara
	Base de instalación	1	Soporte para el montaje al aire libre
	Accesorio de impermeabilización	1	Instale y utilice donde haya mucha humedad.

## VISTA

### Aspecto

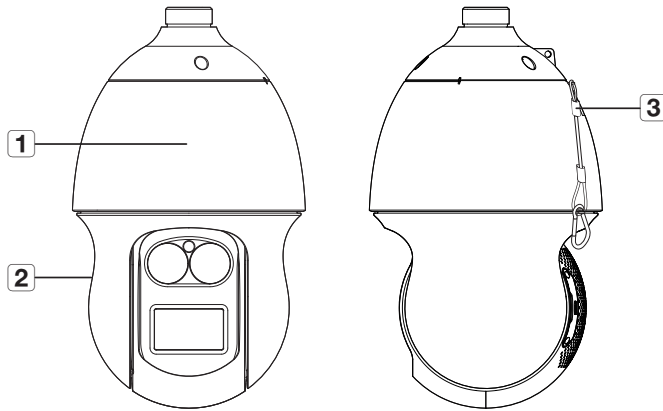

Elemento	Descripción
<b>1</b> Unidad principal	Protege el mecanismo interno de PTZ de la luz directa del sol, la lluvia o impactos externos.
<b>2</b> Tapa protectora	Tapa para protección de la lente y la unidad.
<b>3</b> Cable de seguridad	El cable evita que el producto se caiga durante la instalación.

### Interior

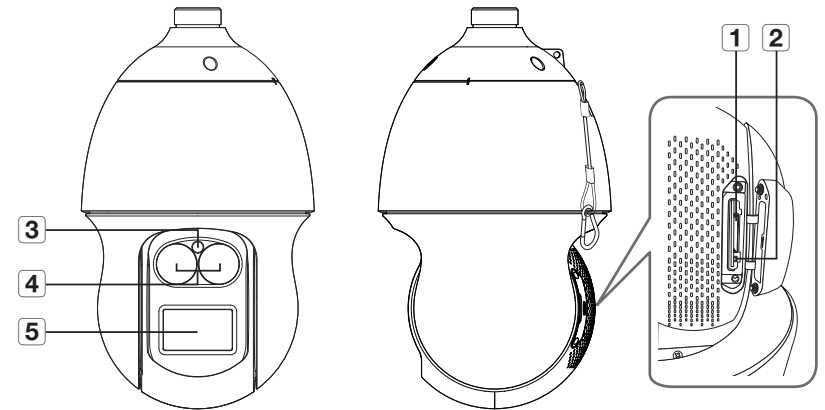

Elemento	Descripción
<b>1</b> Compartimento de la tarjeta de memoria SD	Compartimento de la tarjeta de memoria SD. ☑ Consulte <Insertar/Eliminar una Tarjeta de Memoria SD> para saber la posición de introducción/colocación de la tarjeta de memoria SD. (página 14)
<b>2</b> Botón de reinicialización	Este botón restaura los valores predeterminados de la cámara. Manténgalo pulsado durante unos 5 segundos para reiniciar el sistema. ❗ Si reinicia la cámara, los ajustes de red se ajustarán de forma que se pueda habilitar DHCP. Si no hay ningún servidor DHCP en la red, debe ejecutar el programa del Device Manager para cambiar los ajustes básicos de la red tales como la dirección IP, la máscara de subred, la puerta de enlace, etc., antes de poder conectarse a la red.
<b>3</b> Sensor de iluminación	Detecta la luz entrante para controlar el LED de infrarrojos.
<b>4</b> LED IR	Son LED de infrarrojos que se controlan mediante un sensor de iluminación.
<b>5</b> Objetivo	Objetivo de la cámara.

Vista inferior de la base de instalación

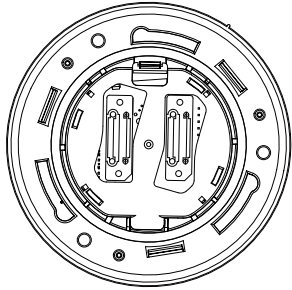

Vista interior de la base de instalación

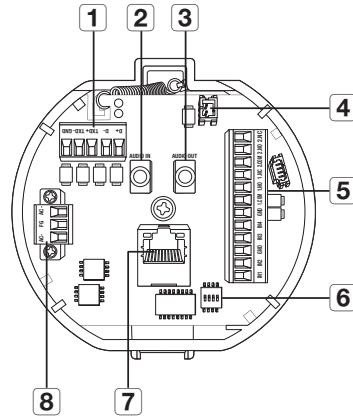

Elemento	Descripción
<b>1</b> Puertos de comunicaciones	Se utiliza para comunicaciones RS-485.
<b>2</b> Puerto de entrada de audio	Se utiliza para conectar el cable de entrada de audio.
<b>3</b> Puerto de salida de audio	Se utiliza para conectar el cable de salida de audio.
<b>4</b> Puerto de salida de vídeo	Puerto de salida de vídeo analógico. (Para instalación.)
<b>5</b> Puerto E/S de alarma	Se utiliza para conectar el cable de E/S de alarma.
<b>6</b> Interruptor de configuración de comunicaciones	Establezca protocolos de comunicación (RS-485) e indique si se debe terminar.
<b>7</b> Conexiones de red	Puerto para la conexión con la red mediante un cable Ethernet.
<b>8</b> Puerto de alimentación	Se utiliza para conectar la alimentación.



## Placa de la interfaz de cableado de la cámara

Para el cableado de la cámara, consulte la imagen que se incluye a continuación.

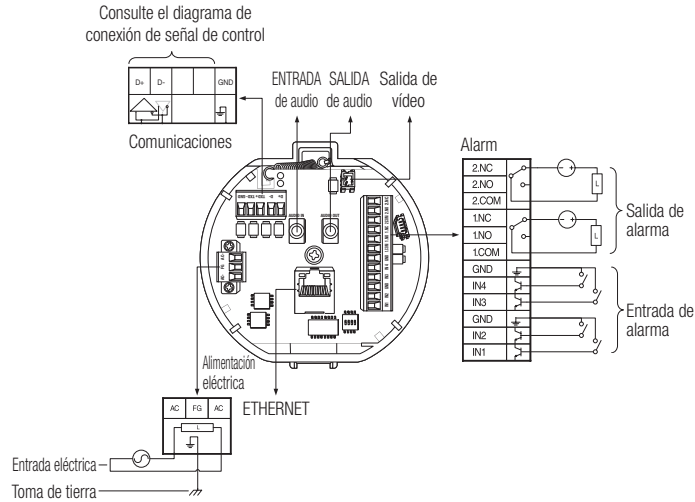

- ! Seleccione Normal Abierto en el menú de configuración.
  - La entrada del sensor se activa durante un cortocircuito para tipo contacto o cuando está en nivel "Bajo" para el tipo activo.
- Seleccione Normal Cerrado en el menú de Configuración.
  - La entrada del sensor se activa cuando está abierto para el tipo contacto o cuando está en estado de alta impedancia (colector abierto) para el tipo activo.
- La capacidad máxima del terminal de salida de la alarma es de 30 V CC/2 A, 125 V CA/0,5 A y 250 V CA/0,25 A.
- Alí conectar los cables de entrada y salida, asegúrese de conectar un cable a cada terminal.
- Para conectar productos por encima de la capacidad de la cámara, utilice un dispositivo de relé adicional.
- Si los cables de la toma de tierra y de alimentación no están conectados correctamente al puerto COM o N/NC, podría producirse un incendio o averiarse el equipo.

## CONEXIÓN CON OTROS DISPOSITIVOS

### Preparación del adaptador y el cable

- ! Conecte la cámara al adaptador de corriente. A continuación, enchufe el cable de alimentación del adaptador en la toma de corriente.

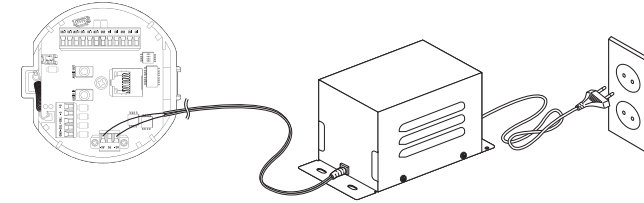

Compruebe la tensión y la corriente nominal antes de realizar las conexiones.

Potencia nominal	Tensión de entrada permitida	Consumo de corriente
24V CA	CA 22V ~ 26V	6 A

- ! El producto no se puede usar a temperatura ambiente de -50°C o inferior.
- Este producto no se puede descongelar según el área de instalación -50°C.
- Si el producto ha permanecido en un ambiente de baja temperatura, tardará unas 2 horas en volver a funcionar con normalidad.
- La velocidad de zoom del atenuador IR disminuye en ambientes de -40°C o menos.
- Si se enciende el producto antes de estar expuesto a un ambiente de -20°C o menos durante un tiempo, es necesario poner el tiempo a cero.

### Resistencia eléctrica de cable de cobre a [20°C (68°F)]

Calibre de hilo americano (AWG)	#24(0.22mm <sup>2</sup> )	#22(0.33mm <sup>2</sup> )	#20(0.52mm <sup>2</sup> )	#18(0.83mm <sup>2</sup> )
Resistencia (Ω/m)	0.078	0.050	0.030	0.018
Tensión de caída (V/m)	0.028	0.018	0.011	0.006
Distancia recomendada (m)	Menos de 20	Menos de 30	Menos de 30	Menos de 30

- Como se muestra en la tabla anterior, es posible que encuentre un punto de tensión baja dependiendo de la longitud del cable. Si tiene un cable excesivamente largo para la conexión de la cámara, es posible que la cámara no funcione debidamente.
  - Tensión de servicio de la cámara: 24 VCA ±10%
  - Las mediciones de caída de tensión del diagrama anterior pueden variar dependiendo del tipo y el fabricante del cable de cobre.

### Conexión Ethernet

Conecte el cable Ethernet a la red local o a Internet.

## Conexión del monitor de instalación

Conecte el cable al terminal de salida de vídeo de la parte trasera de la cámara y el terminal de entrada de vídeo del monitor de instalación.

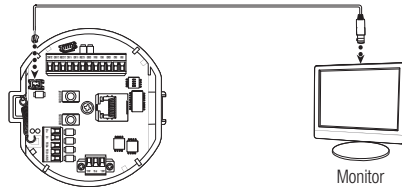

- El cableado varía dependiendo del tipo de monitor y de los dispositivos periféricos; consulte el manual del usuario de cada dispositivo.
- Asegúrese de que el monitor y la cámara estén apagados cuando se conecten.

- !**
- El producto es una cámara de red que transfiere vídeo por una red; el terminal de salida de vídeo se utiliza para ajustar el rango de imágenes de la cámara en la instalación.
  - La utilización del terminal para vigilancia puede causar problemas como la degradación de la calidad del vídeo.
  - No apto para control profesional de 24 horas usando monitores de TRC profesionales o monitores portátiles TFT/LCD.
  - Use la pantalla de transferencia de red para el control y almacenamiento de 24 horas.

## INSTALACIÓN

### Preparación e instalación del soporte de la cámara

Para obtener instrucciones de instalación de los soportes y carcassas, consulte el manual de instalación que se incluye con los mismos.

#### Modelos de soportes disponibles

Modelo	Elemento
SBP-300WM1	Soporte de pared
SBP-300WM	
SBP-300CM	Soporte de montaje en techo
SBP-300LM	Soporte de parapeto
SBP-300KM	Soporte para esquina
SBP-300PM	Soporte para poste

- !** Consulte "Accesorios opcionales para la instalación" para ver el aspecto de cada soporte (no se incluye). (Página 12)

## Instalación mediante el soporte de pared

### Fije la base de instalación con la abrazadera

- Fije la base de instalación con la abrazadera girando a la derecha.

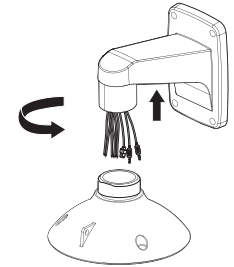

- Como se muestra en la imagen que se incluye a continuación, presione suavemente y levante la manivela de la puerta con asa situada en la parte inferior de la base de instalación. Consulte "Placa de la interfaz de cableado de la cámara" en la página 9, conecte los cables.

- !**
- No conecte la cámara a una toma de corriente hasta completar la instalación. El suministro de alimentación mientras se realiza la instalación puede causar un incendio o daños en el producto.

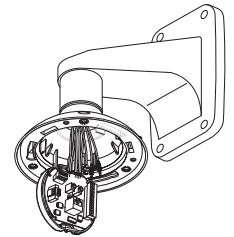

- !** Compruebe el método de conexión por cable e instale.

- Tenga en cuenta que los **CASQUILLOS** se facilitan para instalaciones exteriores donde existen condiciones de humedad a través del **TUBO o MONTAJE**, instale el **CASQUILLO** utilizando el **CASQUILLO** para impedir la entrada de humedad.

- Aplice grasa en la dosis apropiada en el **CASQUILLO** antes del montaje y dirija los cables por cada orificio de los casquillos. Utilice **PASADORES** para obstruir los orificios vacíos que no tengan cables.
- Monte el **CASQUILLO** en el lado superior del inferior de la **CARCASA** como se muestra en el diagrama que se incluye a continuación. En ese momento, aplique presión de forma uniforme en el **CASQUILLO** para fijarlo bien al **ALOJAMIENTO** como se muestra en el diagrama.

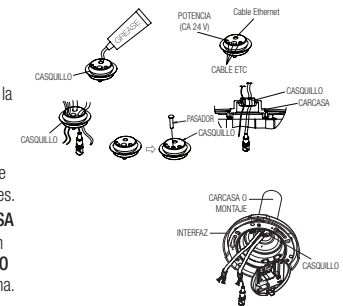

3. Conecte el cable de seguridad de la cámara a la base de instalación.

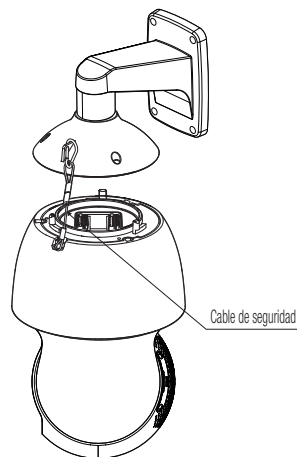

4. Montaje de la cámara y la base de instalación.  
Monte el conjunto de la cámara y la base de instalación haciendo coincidir las guías de dirección de instalación.

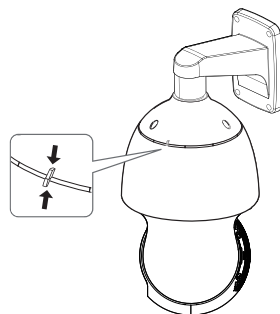

5. Conecte la cámara  
Gire el cuerpo principal de la cámara en sentido horario hasta la posición de la marca de referencia en la sección superior y la sección inferior como se muestra en la figura.

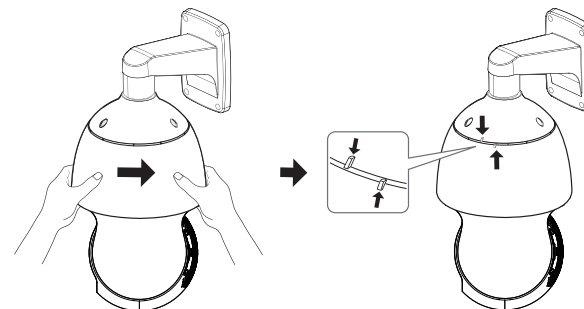

6. Fije la cámara y la base de instalación  
Como se muestra en la imagen a continuación, asegure la base de la instalación y la cámara con tornillos hexagonales.

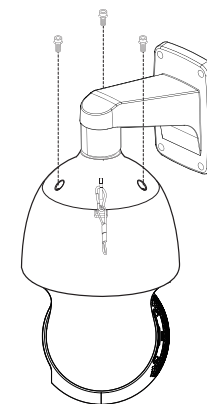

## Advertencias para la impermeabilización

Este modelo es un producto de carcasa integrada para instalación en exteriores.

### ■ Cuando se combina el cuerpo principal y el montaje para instalación en la pared

1. Instale el montaje de pared en la pared vertical. Cuando se instala en una pared inclinada la humedad puede filtrarse en el cuerpo principal a través del cable exterior.
2. Envuelva la parte roscada de la cubierta con la cantidad suficiente de cinta de teflón.
3. Comprobar que la junta no se desmonta de la tapa cuando ésta se separa y se monta en el cuerpo de la carcasa.
4. Instale el adaptador de montaje en la pared para impermeabilización, y aplique sellador de silicona por la pared y entre la pared y el montaje para sellarlo.

**!** ■ Asegúrese que el sellado es correcto en caso que la parte instalada no es plana.

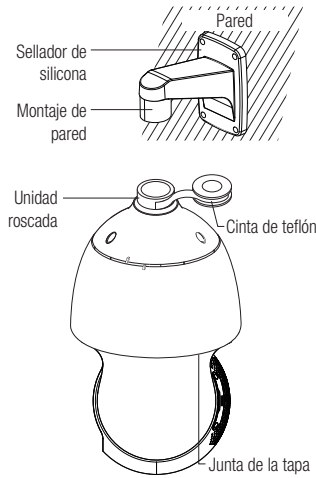

### ■ Al combinar el cuerpo principal y el adaptador de montaje en cielo raso para instalación en la pared

1. Envuelva la parte roscada de la cubierta con la suficiente cantidad de cinta de teflón.
2. Comprobar que la junta no se desmonta de la tapa cuando ésta se separa y se monta en el cuerpo de la carcasa.
3. Instale el adaptador de montaje superior para impermeabilización, aplicando sellador de silicona por la pared y entre la pared y el montaje hasta que quede bien sellado.

**!** ■ Asegúrese que el sellado es correcto en caso que la parte instalada no sea plana.

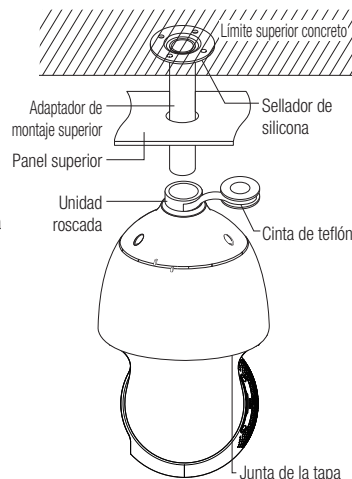

## Accesorios opcionales para la instalación

Para una instalación más sencilla, puede adquirir los accesorios opcionales apropiados disponibles.

1. Si se instala la cámara en la pared
  - Soporte de pared (SBP-300WM1)

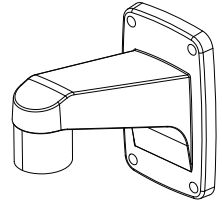

- Soporte de pared (SBP-300WM)

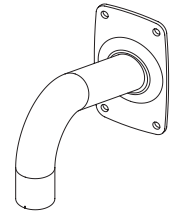

2. Si se instala la cámara en el techo
  - Soporte de montaje en techo (SBP-300CM)

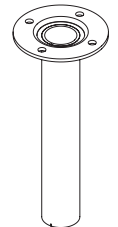

3. Si se instala en el soporte de pared (SBP-300WM/SBP-300WM1) en un cilindro de al menos 80 mm de longitud
  - Soporte para poste (SBP-300PM)

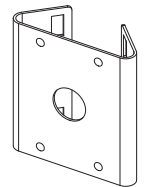

4. Si se instala en el soporte de pared (SBP-300WM /SBP-300WM1) en una esquina

- Soporte para esquina (SBP-300KM)

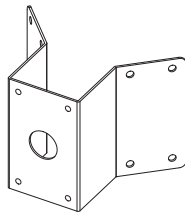

▪ Junta del montaje

5. Si se instala en el tejado de un edificio

- Soporte de parapeto (SBP-300LM)

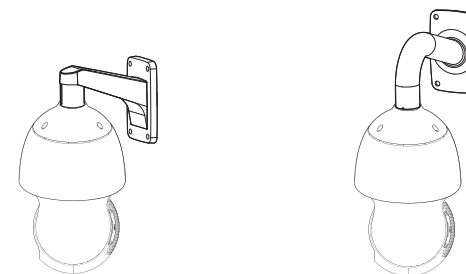
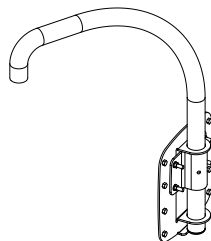

Soporte de pared (SBP-300WM1)

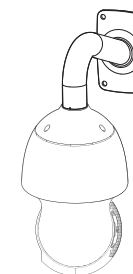

Soporte de pared (SBP-300WM)

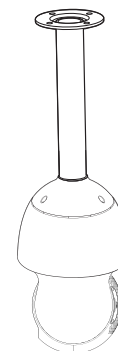

Soporte de montaje en techo (SBP-300CM)

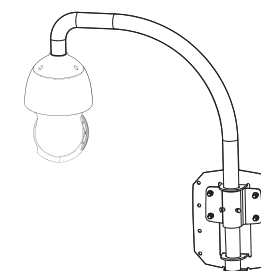

Soporte de parapeto (SBP-300LM)

## INSERTAR/ELIMINAR UNA TARJETA DE MEMORIA SD

- ❗ Desconecte el cable de alimentación de la cámara antes de insertar la tarjeta de memoria SD.
- No se recomienda retirar la tarjeta de memoria SD con tiempo lluvioso o muy húmedo.
- Ajuste los tornillos cuando monte el cuerpo de la cámara, la tapa protectora y el soporte del portador de la SD para evitar que penetre la humedad.
- Cuando se monta o desmonta una tarjeta de memoria SD, coloque primero el cuerpo principal en el suelo para evitar pérdidas de piezas o posibles caídas.

### Insertar una Tarjeta de Memoria SD

1. Con la ayuda del destornillador afloje los dos tornillos del soporte de la pieza de SD girándolos en el sentido contrario a las agujas del .

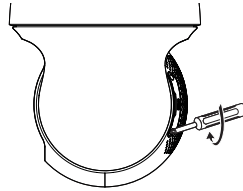

- ❗ No retire los tornillos.

2. Tire del soporte de la pieza de SD y presione la tarjeta de memoria SD en dirección de la flecha, tal y como se indica en la figura.

- ❗ No inserte al revés la tarjeta de memoria SD a la fuerza. Si lo hace, podría dañar la tarjeta de memoria SD.

3. Monte la cámara en el orden contrario al desmontaje después de introducir la tarjeta de memoria.

- ❗ Apriete los tornillos cuando monte la cámara para impedir que penetre la humedad.

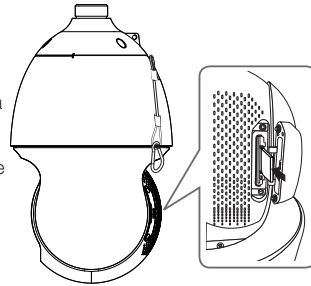

### Eliminar una Tarjeta de Memoria SD

Presione suavemente hacia abajo en el extremo expuesto de la tarjeta de memoria como se muestra en el esquema para sacarla de la ranura.

- ❗ Si presiona muy fuerte sobre la tarjeta de memoria SD, puede hacer que la tarjeta salga disparada de la ranura cuando la libera.
- Antes de extraer la tarjeta de memoria SD, configure el dispositivo en <Des> en <Almacenamiento> menú, presione el botón [Aplicar] y apague la cámara.
- Si apaga la cámara o retira la tarjeta de memoria SD que contiene datos, puede perderlos o dañarlos.

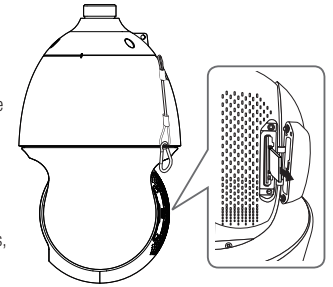

Puede fijar la configuración de red de acuerdo con sus configuraciones de red.

## CONECTAR LA CÁMARA DIRECTAMENTE A LA RED DE ÁREA LOCAL

### Conectar con la cámara desde un ordenador local en la LAN

1. Abrir un navegador de Internet en su ordenador local.
2. Introduzca la dirección IP de la cámara en la barra de direcciones del navegador.

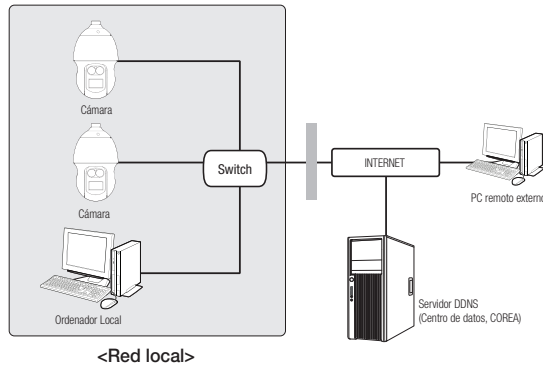

- Un ordenador remoto con una Internet externa fuera de la red LAN podría no poder conectarse a la cámara instalada en la intranet, en caso de que el reenvío de puertos no esté correctamente configurado o se haya instalado un cortafuegos. En este caso, para solucionar el problema, póngase en contacto con su administrador de red.
- En el Device Manager, puede utilizar la contraseña inicial, "4321", para configurar la dirección IP, la máscara de subred, la puerta de enlace, el puerto HTTP, el puerto VNP y el tipo de IP. Después de cambiar la interfaz de red, para mayor seguridad, acceda al visor web y cambie la contraseña.
- Como valor predeterminado de fábrica, la dirección IP se asignará automáticamente desde el servidor DHCP. Si no hay ningún servidor DHCP disponible, la dirección IP se definirá en 192.168.1.100. Para cambiar la dirección IP, utilice el Device Manager. Para obtener más información sobre el uso del Device Manager, consulte "Cómo usar el Device Manager". (página 17)

## CONEXIÓN DIRECTA DE LA CÁMARA A UN MÓDEM DSL/CABLE BASADO EN DHCP

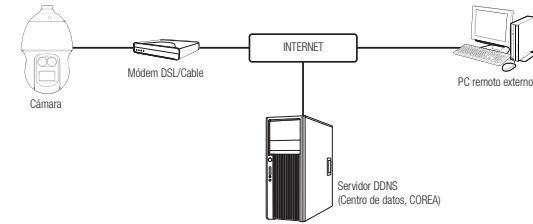

1. Conectar el PC del usuario directamente a la cámara de red.
2. Ejecute el Device Manager y cambie la dirección IP de la cámara de tal manera que pueda usar el navegador web en su ordenador de sobremesa para conectarse a Internet.
3. Utilice el navegador de Internet para conectar a Web Viewer.
4. Vaya a la página [Config.].
5. Vaya a [Red] – [DDNS] y configure los ajustes de DDNS.
6. Vaya a [Basic] – [IP & Puerto] y establezca el tipo de IP para [DHCP].
7. Conecte la cámara, retirada del PC, directamente en el módem.
8. Reinicie la cámara.

- Para obtener información sobre cómo configurar el DDNS, consulte la ayuda en línea de Web Viewer.
- Para obtener información sobre cómo configurar el formato de IP, consulte la ayuda en línea de Web Viewer.

## CONEXIÓN DE LA CÁMARA DIRECTAMENTE AL MÓDEM PPPoE

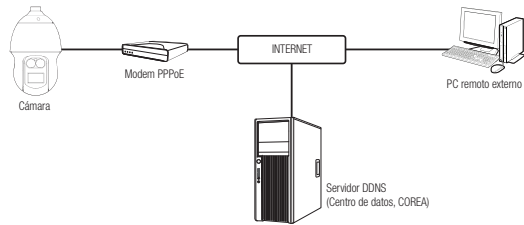

1. Conectar el PC del usuario directamente a la cámara de red.
2. Ejecute el Device Manager y cambie la dirección IP de la cámara de tal manera que pueda usar el navegador web en su ordenador de sobremesa para conectarse a Internet.
3. Utilice el navegador de Internet para conectarse a Web Viewer.
4. Vaya a la página **[Config.]**.
5. Vaya a **[Red]** – **[DDNS]** y configure los ajustes de DDNS.
6. Vaya a la página de configuración **[Basic]** – **[IP & Puerto]**, establezca el tipo de IP para **[PPPoE]** e introduzca el ID de servicio de red y la contraseña.
7. Conecte la cámara, retirada del PC, directamente en el módem.
8. Reinicie la cámara.

- Para obtener información sobre cómo configurar el DDNS, consulte la ayuda en línea de Web Viewer.
- Para obtener información sobre cómo configurar el formato de IP, consulte la ayuda en línea de Web Viewer.

## CONECTAR LA CÁMARA A UN ENRUTADOR DE BANDA ANCHA CON EL MÓDEM PPPoE/CABLE

Se utiliza para un ambiente de red pequeño como hogares, oficinas pequeñas y tiendas normales.

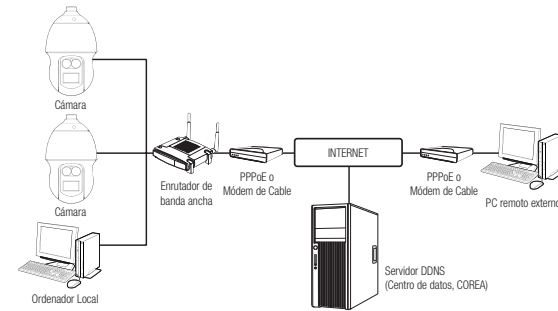

### Configurar la red del ordenador local conectado a un Enrutador de banda ancha

Configure la configuración de red del ordenador local conectado a un enrutador de banda ancha, siga las instrucciones siguientes.

- Selección: **<Network>** → **<Properties>** → **<Local Area Connection>** → **<General>** → **<Properties>** → **<Internet Protocol (TCP/IP)>** → **<Properties>** → **<Obtain an IP address automatically>** o **<Use the following IP address>**.
- Siga las siguientes instrucciones si selecciona **<Use the following IP address>**:
  - ej.1) Si la dirección (LAN IP) del enrutador de banda ancha es 192.168.1.1  
Dirección IP : 192.168.1.100  
Máscara de subred : 255.255.255.0  
Puerta de enlace por defecto : 192.168.1.1
  - ej.2) Si la dirección (LAN IP) del enrutador de banda ancha es 192.168.0.1  
Dirección IP : 192.168.0.100  
Máscara de subred : 255.255.255.0  
Puerta de enlace por defecto : 192.168.0.1
  - ej.3) Si la dirección (LAN IP) del enrutador de banda ancha es 192.168.xxx.1  
Dirección IP : 192.168.xxx.100  
Máscara de subred : 255.255.255.0  
Puerta de enlace por defecto : 192.168.xxx.1

- Para obtener la dirección del enrutador de banda ancha, véase la documentación del producto.
- Para obtener información adicional sobre el reinicio de puertos del enrutador de banda ancha, consulte **"Configuración de Reenvío del Rango de Puertos (Asignación de Puertos)"**. (Página 19)



## CÓMO USAR EL DEVICE MANAGER

- Puede descargar el programa del Device Manager desde el menú <Technical Guides> – <Online Tool> en el sitio web de Hanwha Techwin (<http://www.hanwha-security.com>).
- Asimismo, puede encontrar más instrucciones sobre el Device Manager en el menú <Ayuda> de la página principal.

## BÚSQUEDA AUTOMÁTICA DE LA CÁMARA

Si hay una cámara conectada a la misma red del ordenador en donde está instalado el Device Manager, puede encontrar esa cámara de la red usando la función de buscar.

1. Haga clic en <Buscar> en la página principal del Device Manager.
2. Marque la cámara de la lista.
  - Compruebe la dirección MAC en el adhesivo de la cámara.

## CÓMO CONFIGURAR LA DIRECCIÓN IP

Si desea cambiar el ajuste de la red de la cámara, el signo <Inicio de sesión Aceptar> debe aparecer en el campo <Estado>. Haga clic en el campo <Autenticación> de la página principal para iniciar sesión.

### Configuración de la IP estática

Inserte y configure manualmente la dirección IP y la información del puerto.

1. Haga clic en la cámara de la lista para la que desea cambiar el ajuste de la IP.
2. Haga clic en <IP Assign (Asignación de la IP)> en la página principal del Device Manager.
3. Seleccione <Asignar la siguiente dirección IP>.
  - La información IP de la cámara de mostrará según se ha configurado previamente.
4. Complete las categorías relacionadas con el campo IP & Puerto.

### Si no se utiliza un Enrutador de banda ancha

Pida al administrador de la red que establezca el valor de la <Dirección IP>, la <Máscara subred> y la <Gateway(Puerta de enlace)>.

- HTTP Puerto : se utiliza para acceder a la cámara utilizando el explorador de Internet, por defecto en 80.
- VNP Puerto : se utiliza para controlar la transferencia de señales de vídeo, por defecto en 4520.
- RTSP Puerto : este puerto controla la transmisión de datos en tiempo real. Su valor inicial es 554.

### Si se utiliza un Enrutador de banda ancha

- IP Address : introduzca una dirección que se encuentre en el rango de IP facilitado por el enrutador de banda ancha. ej.) 192.168.1.2~254, 192.168.0.2~254, 192.168.XXX.2~254
- Subnet Mask : La <Subnet Mask> del enrutador de banda ancha será la <Subnet Mask> de la cámara.
- Gateway : La <Local IP Address> del enrutador de banda ancha será la <Gateway> de la cámara.

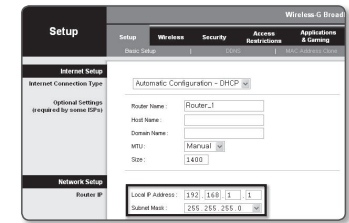

- Es posible que los ajustes difieran dependiendo del modelo de enrutador de banda ancha conectado. Para obtener información adicional, consulte el manual de usuario del enrutador aplicable.
- Para obtener información adicional sobre el reenvío de puertos del enrutador de banda ancha, consulte "Configuración de Reenvío del Rango de Puertos (Asignación de Puertos)". (Página 19)

### Si el Enrutador de banda ancha tiene más de una cámara conectada

Configure los ajustes relacionados con IP y los ajustes relacionados con Port de forma distinta entre sí. ej.)

	Categoría	Cámara 1	Cámara 2
Ajustes relacionados con IP	Dirección IP	192.168.1.100	192.168.1.101
	Máscara subred	255.255.255.0	255.255.255.0
	Gateway	192.168.1.1	192.168.1.1
Ajustes relacionados con el puerto	HTTP Puerto	8080	8081
	VNP Puerto	4520	4521
	RTSP Puerto	554	555

- Si <HTTP Puerto> se define con un valor distinto a 80, debe facilitar el número de <Port> en la barra de direcciones del explorador de Internet antes de poder acceder a la cámara. ej.) <http://Dirección IP : HTTP Port>  
<http://192.168.1.100:8080>

5. Haga clic en el botón [Aplicar].
6. Si aparece el mensaje de que la acción se ha realizado correctamente, haga clic en [Aceptar].

## Configuración de la IP dinámica

Reciba la dirección IP desde DHCP

- Ejemplo de entorno de IP dinámica
  - Si a un enrutador de banda ancha, con cámaras conectadas, se le asigna una dirección IP mediante el servidor DHCP
  - Si se conecta la cámara directamente al módem utilizando los protocolos DHCP
  - Si las IP se asignan mediante el servidor DHCP interno a través de la LAN

1. Haga clic en la cámara de la lista para la que quiera cambiar la configuración de la IP.
2. Haga clic en **<IP Assign (Asignación de la IP)>** en la página principal del Device Manager.
3. Seleccione **<Obtener una dirección IP automáticamente (DHCP)>**.
4. Haga clic en botón **[Aplicar]**.
5. Si se muestra el mensaje de acción realizada correctamente, haga clic en **[Aceptar]**.

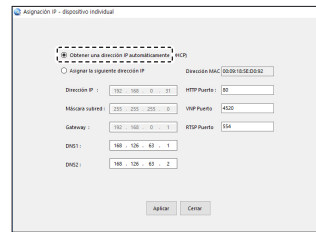

## CONFIGURACIÓN AUTOMÁTICA DE LA IP

1. Haga clic en la cámara de la lista para la que quiera configurar automáticamente la IP.
2. En la página principal del Device Manager, haga clic en **< + >**.
  - Aparecerá el menú de configuración del equipo.
3. En el menú, haga clic en **<Auto IP Configure (Configuración IP automática)>**.
4. Haga clic en el botón **[Cerrar]**.

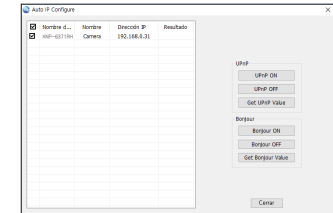

## CÓMO REGISTRAR LA CÁMARA MANUALMENTE

Si la cámara no puede encontrarse usando la función de buscar, puede registrarla remotamente insertando manualmente la información de la IP si la cámara está conectada a la red externa.

1. Haga clic en **<Add Devices (Agregar dispositivos)>** – **<Añadir dispositivo manualmente>** de la página principal del Device Manager.
2. Inserte el intervalo de la dirección IP que está buscando.
3. Seleccione el **<Nombre del modelo>** de la cámara que ha registrado e inserte el puerto HTTP, el puerto VNP, la ID y la contraseña.
4. Haga clic en el botón **[Registro]**.
5. Compruebe que la cámara esté registrada.
  - Verifique la dirección MAC en el adhesivo de la cámara.

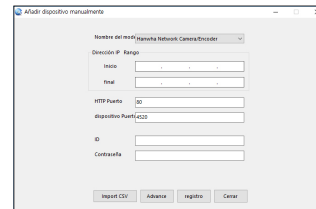

## CONFIGURACIÓN DE REENVÍO DEL RANGO DE PUERTOS (ASIGNACIÓN DE PUERTOS)

Si ha instalado un enrutador de banda ancha con una cámara conectada, debe definir el reenvío del rango de puertos en el enrutador de banda ancha de forma que un PC remoto pueda acceder a la cámara en él.

### Reenvío manual del rango de puertos

1. En el menú de configuración del enrutador de banda ancha, seleccione **<Applications & Gaming>** - **<Port Range Forward>**.

Para definir el reenvío del rango de puertos para un enrutador de banda ancha de terceros, consulte el manual del usuario de dicho enrutador de banda ancha.

2. Seleccione **<TCP>** y **<UDP Port>** por cada cámara conectada al enrutador de banda ancha.

El número de cada puerto que se configura para el router IP debe establecerse de acuerdo con el número de puerto designado en **<Config.>** - **<Basic>** - **<IP & Puerto>** en el visor web de la cámara.viewwer.

3. Una vez hecho, haga clic en **[Save Settings]**. Se guardarán los ajustes.

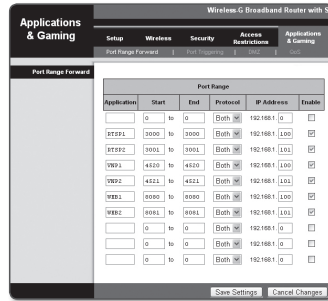

- El ajuste del reenvío del puerto es un ejemplo de configuración del router de la IP de CISCO.
- Es posible que los ajustes difieran dependiendo del modelo de enrutador de banda ancha conectado. Para obtener información adicional, consulte el manual de usuario del enrutador aplicable.

### Configuración del reenvío del rango de puertos de varias cámaras de red

- Puede definir una regla de reenvío de puertos en el dispositivo enrutador de banda ancha a través de su página Web de configuración.
- Un usuario puede cambiar los puertos usando la pantalla de configuración de la cámara.

Cuando la Cámara 1 y la Cámara 2 estén conectadas a un enrutador :

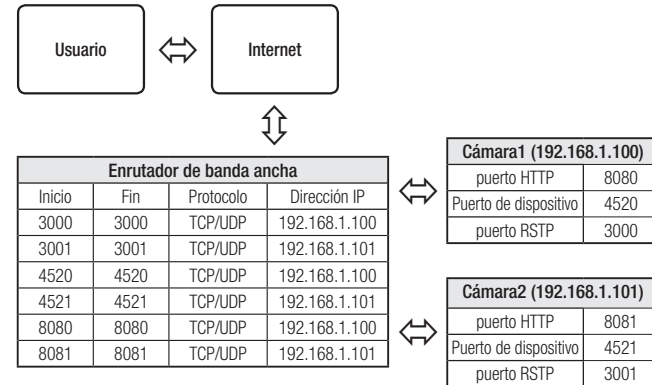

- El enrutamiento de puerto se puede hacer sin una configuración adicional del router si este está adaptado para la función UPnP (Universal Plug and Play). Después de conectar la cámara de red, seleccione la casilla de verificación del menú **<Conexión rápida>** en **<Wisenet DDNS>** en **"Configuración -> Red -> DDNS"**.

## CONEXIÓN A LA CÁMARA DESDE UN PC LOCAL COMPARTIDO

---

1. Ejecute el Device Manager.  
Rastreará las cámaras conectadas y mostrará una lista de ellas.
2. Haga doble clic en una cámara para acceder a ella.  
Se inicia el explorador de Internet y se conecta a la cámara.

 ■ También puede acceder a la cámara introduciendo la dirección IP de la cámara encontrada en la barra de direcciones del explorador de Internet.

## CONEXIÓN A LA CÁMARA DESDE UN PC REMOTO A TRAVÉS DE INTERNET

---

En un ordenador remoto que no esté en el clúster de la red del router de banda ancha no está permitido, por lo que los usuarios pueden acceder a las cámaras dentro de la red de un router de banda ancha mediante el uso de la URL del DDNS de la cámara.

1. Antes de poder acceder a una cámara de una red de enrutador de banda ancha, debe haber definido el reenvío del rango de puertos para el enrutador de banda ancha.
2. Desde el PC remoto, inicie el explorador de Internet e introduzca la dirección URL de DDNS de la cámara, o la dirección IP del enrutador de banda ancha en la barra de direcciones.  
ej.) <http://ddns.hanwha-security.com/ID>

 ■ Para utilizar el DDNS de Wisenet, regístrese en la página de inicio del DDNS de Wisenet (<http://ddns.hanwha-security.com>) y registre el producto en **[Mi DDNS]>[Registrar producto]**.

## CONEXIÓN A LA CÁMARA

### Procedimiento normal

1. Inicie el explorador de Internet.
2. Introduzca la dirección IP de la cámara en la barra de direcciones.
  - ej.) • Dirección IP (IPv4) : 192.168.1.100 → http://192.168.1.100
  - Debe aparecer el diálogo de inicio de sesión.
  - Dirección IP (IPv6) : 2001:230:abcd:ffff:0000:0000:ffff:1111 → http://[2001:230:abcd:ffff:0000:0000:ffff:1111] - Debe aparecer el diálogo de inicio de sesión.

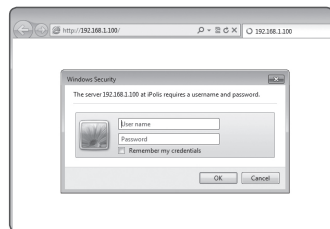

### Si el número de puerto HTTP no es 80

1. Inicie el explorador de Internet.
2. Introduzca la dirección IP y el número de puerto HTTP de la cámara en la barra de direcciones.
  - ej.) Dirección IP : 192.168.1.100:HTTP Port number(8080)
  - http://192.168.1.100:8080 - Debe aparecer el diálogo de inicio de sesión.

### Utilización del URL

1. Inicie el explorador de Internet.
2. Introduzca el URL de DDNS de la cámara en la barra de direcciones.
  - ej.) Dirección URL : http://ddns.hanwha-security.com/ID
  - Debe aparecer el diálogo de inicio de sesión.

 La conexión de red está desactivada en el entorno LAN.

### Conexión a través de UPnP

1. Ejecute el sistema cliente o sistema operativo para el protocolo UPnP.
2. Haga clic en el nombre de la cámara para realizar la búsqueda.
  - En el sistema operativo Windows, haga clic en el nombre de la cámara de búsqueda en el menú de red.
  - Aparece la ventana de inicio de sesión.

### Conexión a través de Bonjour

1. Ejecute el sistema cliente o el sistema operativo para el protocolo Bonjour.
2. Haga clic en el nombre de la cámara para realizar la búsqueda.
  - En el sistema operativo Mac, haga clic en el nombre de la cámara buscada desde la pestaña Bonjour de Safari.
  - Aparece la ventana de inicio de sesión.

### Para comprobar la dirección de DDNS

Si la cámara está conectada directamente al módem de cable DHCP, al módem DSL o al módem PPPoE, la dirección IP de la red cambiará cada vez que intente conectar al servidor del proveedor de servicios de Internet.

Si este es el caso, no se le informará de la dirección IP modificada por el DDNS.

Una vez que registre el dispositivo con IP dinámica en el servidor DDNS, puede fácilmente cambiar la IP modificada cuando intente acceder al dispositivo.

Para registrar el dispositivo en el servidor de <DDNS>, entre en http://ddns.hanwha-security.com y registre primero el dispositivo y, a continuación, establezca <Red> - <DDNS> de Web Viewer en <DDNS de Wisenet>, y facilite el <ID de producto> utilizado durante el registro de DDNS.

## CONFIGURACIÓN DE CONTRASEÑA

Al acceder al producto por primera vez, debe registrar la contraseña de inicio de sesión.

Cuando aparezca la ventana “Cambiar contraseña”, introduzca la contraseña nueva.

- Para una nueva contraseña que tenga entre 8 y 9 dígitos, debe utilizar por lo menos 3 mayúsculas/ minúsculas, 3 números y 3 caracteres especiales. Para una contraseña que tenga entre 10 y 15 dígitos, debe utilizar por lo menos 2 de los tipos mencionados.
  - Caracteres especiales que se permiten. : ~!@#%&^\*()\_+={}|[]?/
- Para mayor seguridad, no se recomienda repetir los mismos caracteres ni entradas consecutivas de teclado en las contraseñas.
- Si ha perdido su contraseña, puede pulsar el botón **[RESET]** para iniciar el producto. Así pues, no pierda la contraseña utilizando un bloc de notas o memoricela.

## INICIO DE SESIÓN

Siempre que acceda a la cámara, aparecerá la ventana de inicio de sesión.

Introduzca el ID de usuario y la contraseña para acceder a la cámara.

1. Introduzca “**admin**” en el cuadro de entrada <User name>. La ID del administrador, “**admin**”, es fija y no es posible cambiarla.
2. Introduzca la contraseña en el campo de entrada <Password>.
3. Haga clic en **[OK]**.  
Si ha iniciado sesión correctamente, verá la pantalla de Live Viewer.

- Al acceder al visor de la cámara web, preste especial atención a la seguridad comprobando que los datos de imagen estén encriptados.
- Si marca la opción “**Remember my credentials**” una vez realizada la entrada, la próxima vez se iniciará sesión automáticamente sin que se le pida introducir la información de inicio de sesión.
- Podrá disfrutar de la mejor calidad de vídeo si el tamaño de pantalla es del 100%. Si se reduce la relación existe el riesgo de cortar la imagen en los bordes.

## ESPECIFICACIONES DE COMPATIBILIDAD DEL PLUG-IN PARA CADA NAVEGADOR

El visor web incluye el visor web con plugins actual y el nuevo visor web libre de plugins. Por esta razón, el visor web está disponible en los últimos entornos de navegador como Chrome, EDGE, Firefox (solo Windows 64-bit) donde plugins no son compatibles. Los plugins son recomendados para los navegadores IE y Safari para en los que sí se pueden instalar plugins. Según el entorno del navegador, pueden ocurrir las siguientes diferencias.

- **Navegadores Chrome, Firefox (solo Windows 64-bit), EDGE y Safari** : Incluso si el entorno del buscador no es compatible con ningún plugin, nuestro visor web libre de plugins permite el uso del visor web.
  - El rendimiento del visor web libre de plugins puede ser más bajo que el del visor web con plugins en función del códec y resolución de vídeo.
    - Si existen retrasos en el vídeo en vivo, un perfil libre de plugins (HD de H.264 (1280x720) 20FPS) se genera automáticamente.
    - Para la reproducción, pueden ocurrir retrasos en función del códec y la resolución.
  - La función de libre de plugins se optimiza para el navegador Chrome.
- **Navegadores IE y Safari** : Puede utilizar un visor web, incluso si no instala el visor web de plug-in existente.
  - Para supervisar/reproducir vídeos guardados sin problemas, es necesario instalar un plug-in.

## INSTALACIÓN DEL PLUGIN WebViewer

Si accede al visor web libre de plugins con el buscador IE e intenta utilizar funciones, como solicitar un vídeo en vivo o reproducir un vídeo grabado, se mostrará un mensaje de instalación. Cuando aparezca, debe instalar el plugin del visor de web para poder utilizar las funciones.

1. Cuando se accede por primera vez a la página de monitorización, se muestra la página de instalación. Haga clic [**Click Here**] en iniciar instalación.

! Si el estado de la descarga del archivo plug-in de instalación se suspende en el 99% en el navegador Internet Explorer, vuelva a intentarlo tras seleccionar "Release SmartScreen filter" en "Tool → SmartScreen filter".

2. Haga clic [**Run**] en la ventana de mensaje.
3. Haga clic [**Yes**] cuando aparezca una ventana que notifica que se cerrarán todas las ventanas del navegador.

✍ Los pasos 4 y 5 se omitirán si el Plug-in Web Viewer está instalado.

4. Cuando está instalada la antigua versión del Web Viewer Plug-in, se muestra una ventana de aviso que la versión antigua se borrará la pantalla. Haga clic [**Yes**] cuando la ventana de aviso aparece en la pantalla.

5. Haga clic en [**OK**].  
La versión anterior del Plug-in Web Viewer se elimina.

6. Haga clic en [**Install**] para iniciar la instalación del Plug-in Web Viewer.

7. Haga clic en [**Finish**].  
La instalación del Plug-in Web Viewer se ha completado.

! En el explorador de Internet, si necesita pasar a la pantalla de instalación después de instalar el plugin de visor web, compruebe si `webviewer_activeplugin_lib.control` en el menú "Herramientas → Gestión de función adicional" está "Activado". Si no, y si hay un problema que persiste, a continuación, seleccione "Herramientas → Opciones de Internet → General" y borre todos los registros de búsqueda. Si todavía no funciona, ve a "Herramientas → Opciones de Internet → Seguridad → Sitios de confianza" y registre su IP o dominio de la cámara.

## USO DEL VISOR WEB SIN PLUG-IN

Si accede a la cámara a través del navegador web Google Chrome, Mozilla Firefox o MS Edge, no se instalará ningún plugin, pero aun así podrás ver el vídeo de la cámara en vivo sin instalar plugins.

1. Escriba su nombre de usuario y contraseña para iniciar sesión.
2. Cuando haya iniciado sesión en el sistema, aparecerá una pantalla de visualización en vivo de la cámara.

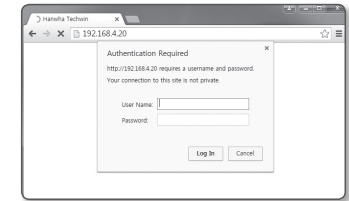

## CONFIGURACIÓN DEL VISOR WEB DE LA CÁMARA

1. Haga clic en el icono [**Configurar** (⚙)].
2. Aparece la ventana de Ajustes.
3. Es posible gestionar los ajustes de la información básica de la cámara, PTZ, vídeo y audio, red, evento, análisis, sistema y plataforma abierta a través de la red.
4. Haga clic en <Ayuda (🔗)> para ver descripciones detalladas de cada función.

## AJUSTE DEL CONMUTADOR DIP

### Cómo configurar protocolos y conmutadores DIP de ID

Puede controlar diversos ajustes del sistema de la cámara utilizando los conmutadores de comunicación y DIP de ID. Antes de instalar el producto, configure los conmutadores DIP de acuerdo con el entorno de instalación.

1. Ajuste los conmutadores según su entorno de instalación. Para obtener información más detallada sobre la configuración, consulte el diagrama que se incluye en la página siguiente.
2. La cámara puede sufrir una avería si los conmutadores no están totalmente encendidos/apagados; vuelva a comprobar los conmutadores antes de finalizar la configuración.
3. Atención, el interruptor puede dañarse si se acciona con una herramienta afilada.
4. Atención, el interruptor puede dañarse si se acciona con demasiada fuerza.

Conmutador DIP de protocolo de comunicaciones (SW1)

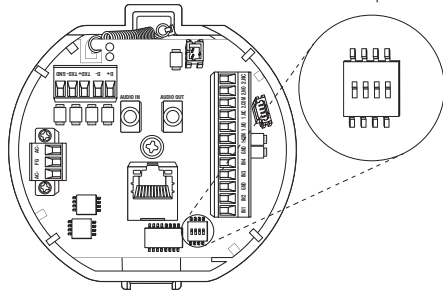

### Ajustes del conmutador DIP de protocolo de comunicaciones (SW1)



Nº de patilla de SW1	Purpose
1	Reservado
2	Ajuste terminación 1
3	Ajuste terminación 2
4	Reservado

### • Ajustes de terminación

Para evitar la atenuación de señales de comunicación entre la cámara y el controlador, deben configurarse los elementos del final de la línea con los ajustes de terminación.

Posición de entrada de cámara	SW1-#2	SW1-#3
Terminación de la ruta más larga	ON	ON
En la ruta	OFF	OFF



- El valor predeterminado se resalta en cada tabla de ajustes.
- Para utilizar con este producto el controlador de otro fabricante, póngase en contacto con el Servicio postventa o con el Departamento de Tecnología.

## CABLES DE LA CÁMARA

### Conexión de señal de control

- Comunicaciones RS-485



### Cable de comunicaciones

Para que la cámara comunique con el controlador, se necesita una línea de comunicaciones RS-485.

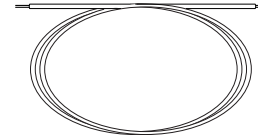

- Para la conexión, se recomienda un cable con una longitud máxima de 30m.
- El cable de comunicaciones no se incluye con la cámara.



## ESPECIFICACIONES

Opciones		Descripción
Video	Dispositivo de imágenes	1/2" 2,17M CMOS
	Píxeles totales	1952(H) x 1113(V), 2,17M
	Píxeles efectivos	1937(H) x 1097(V), 2,12M
	Sistema de barrido	Progresivo
	Iluminación mín.	Color : 0,01 Lux (1/30seg, F1,5) ByN : 0 Lux (LED IR encendido)
	Índice S/N	50dB
	Salida de vídeo	CVBS : 1,0 Vp-p / 75Ω compuesto, 720x480(N), 720x576(P) Para instalación
Objetivo	Longitud focal (índice de zoom)	6~222 mm (Óptico 37X)
	Coefficiente de apertura máx.	F1,5 (Angular) ~ F4,6 (Telescópico)
	Campo de visión angular	H : 59,3°(Angular) ~ 1,9°(Telescópico) / V : 35,8°(Angular) ~ 1,1°(Telescópico)
	Distancia mín. del objeto	Ancho 1,5 m, Tele 2 m
	Control de enfoque	Automático/Manual /EA de disparo
	Tipo de objetivo	Autom. DC
	Tipo montaje	Tipo en placa
Panorámica / Inclinación / Giro	Alcance de panorámica	360° sin final
	Velocidad de panorámica	Preaj. : 400°/seg., Manual : 0,024°/seg ~ 250°/seg
	Rango de inclinación	190°(-5° ~185°)
	Velocidad de inclinación	Preaj. : 300°/seg., Manual : 0,024°/seg ~ 250°/seg
	Secuencia	Preajuste (300ea), Oscilación, Grupo (6ea), Rastreo, Tour, Ejecución automática, Horario
	Precisión de pos. predet.	±0,2°
	Azmut	Sí (E/W/S/N/NE/NW/SE/SW OSD)
	Seguimiento automático	No / Sí

Opciones	Descripción	
Funcionamiento	Título de cámara	No / Sí (Se muestran 85 caracteres) - WW : Inglés/Numérico/Caracteres especiales - Común: Multilínea (Máx 5), color (gris / verde / rojo / azul / negro / blanco), transparencia, escala automática por resolución
	Día y noche	Autom. (ICR) / Color / ByN / Horario
	Compensación de luz de fondo	No / BLC / HLC / WDR
	Rango dinámico amplio	150dB
	Mejora de contraste	SSDR (No / Sí)
	Reducción de ruido digital	SSNR5 (Filtro de ruido 2D+3D) (No / Sí)
	Estabilizador digital de imágenes	Apagado/encendido (sensor Gyro incorporado)
	Desempeñado (Optical)	Autom. / Manual / No
	Detección de movimiento	Des/Act (8ea, rectángulo)
	Máscara de privacidad	No / Sí (24 zonas de zonas rectangulares) - Color : Gris / Verde / Rojo / Azul / Negro / Blanco - Opción de relación de zoom para el modo de máscara - Opción de mosaico
	Control de ganancia	No / Bajo / Medio / Alto
	Balance de blanco	ATW/AWC/Manual/Interior/Exterior (incluido mercurio y sodio)
	Velocidad de obturador electrónico	Mínimo / Máximo / Anti fluctuación (2 ~ 1/12.000 seg)
	Zoom digital	32x
	Rotación de imagen	Volteo / Espejo: Encendido/apagado
	Analítica de vídeo y audio	Manipulación, merodeo, detección direccional, línea virtual, entrada/salida, aparición/desaparición, detección de audio, detección de movimiento, detección de niebla, clasificación de sonido
	Interfaz en serie	RS-485 - Samsung-T, Pelco-D/P, Panasonic, Bosch, AD, GE, Vicon, Honeywell
E/S alarma	Entrada 4ea / Salida 2ea (Tipo de transmisión)	
Se activa la alarma	Entrada de alarma, Detección de movimiento, Analítica de vídeo y audio, Desconexión de red	

Opciones	Descripción
Funcionamiento	<b>Evento de alarma</b> <ul style="list-style-type: none"> <li>• Carga de archivos a través de FTP, correo electrónico</li> <li>• Notificación a través de E-mail, TCP y HTTP</li> <li>• Grabación con almacenamiento local (SD/SDHC/SDXC) o grabación NAS en el Evento (activación de alarmas)</li> <li>• Salida externa</li> <li>• Preconfiguración PTZ</li> </ul>
	<b>Entrada de audio</b> Seleccionable (entrada de micrófono/entrada de línea), Tensión de alimentación: 2.5 VCC (4 mA), Impedancia de entrada: aprox. 2K ohmios
	<b>Salida de audio</b> Salida de línea (cable mono de 3,5 mm), Nivel máximo de salida: 1 Vrms
	<b>Contador de píxeles</b> soporte
Red	<b>Ethernet</b> RJ-45 (10/100BASE-T)
	<b>Formato de compresión de vídeo</b> H.264 (MPEG-Parte 4 10/AVC) : H.265, Movimiento JPEG
	<b>Resolución</b> 1920x1080, 1280x1024, 1280x960, 1280x720, 1024x768, 800x600, 800x448, 720x576, 720x480, 640x480, 640x360, 320x240
	<b>Velo. máx. de fotogramas</b> H.265/H.264: Máx. 60 fps en todas las resoluciones Movimiento JPEG: Máx. 30 fps en todas las resoluciones
	<b>Códec inteligente</b> Modo Manual (área con base: 5EA)
	<b>Ajuste de calidad de vídeo</b> H.264/H.265/MJPEG : Control de nivel de tasa de bits
	<b>Método de control de vel. de bits</b> H.264/H.265 : H.264 / H.265: CBR o VBR, con WiseStream Movimiento JPEG : VBR
	<b>Capacidad de flujo de datos</b> Flujo de datos multiple (hasta 10 perfiles)
	<b>Formato de compresión de audio</b> G.711 $\mu$ -law / G.726 Selectable G.726 (ADPCM) 8KHz, G.711 8KHz G.726 : 16Kbps, 24Kbps, 32Kbps, 40Kbps AAC-LC : 48 kbps a 16 KHz
	<b>Comunicación de audio</b> Bidireccional

Opciones	Descripción
Red	<b>IP</b> IPv4, IPv6
	<b>Protocolo</b> TCP/IP, UDP/IP, RTP(UDP), RTP(TCP), RTCP,RTSP, NTP, HTTP, HTTPS, SSL/TLS, DHCP, PPPoE, FTP, SMTP, ICMP, IGMP, SNMPv1/v2c/v3(MIB-2), ARP, DNS, DDNS, QoS, PIM-SM, UPnP, Bonjour
	<b>Seguridad</b> Autenticación de inicio de sesión HTTPS(SSL) Autenticación de inicio de sesión Digest Filtro de dirección IP Registro de acceso de usuarios Método de autenticación 802.1x (EAP-TLS, EAP-LEAP)
	<b>Método de flujo de datos</b> Unicast / Multicast
	<b>Acceso máx. de usuarios</b> 20 usuarios en modo Unicast
	<b>Almacenamiento Edge</b> SD/SDHC/SDXC (hasta 128 GB) - Se pueden descargar las imágenes en movimiento grabadas en la tarjeta de memoria SD/SDHC/SDXC. - La cámara puede detectar automáticamente cuando se conecta la memoria NAS (Almacenamiento conectado a la red) PC local para grabación instantánea (solo visor de plug-in)
	<b>Interfaz de programación de aplicaciones</b> ONVIF Profile S/G SUNAPI 2.0(HTTP API) WiseNet Open Platform
	<b>Idioma de página web</b> Inglés, Francés, Alemán, Español, Italiano, Chino, Coreano, Ruso, Japonés, Sueco, Portugués, Checo, Polaco, Turco, Holandés, Húngaro, Griego
	<b>Visor Web</b> SO admitido : Windows 7 / 8.1 / 10, MAC OS X 10.10, 10.11, 10.12 <b>Visor web sin plug-in</b> Navegador compatible: Google Chrome, MS Edge, Mozilla Firefox (Windows solo de 64 bit), Safari 10 de Apple (solo Mac OS X) <b>Visor web de plug-in</b> Navegador compatible: MS Explorer 11, Safari 10 de Apple (solo Mac OS X)
	<b>Software de gestión central</b> SmartViewer

Opciones	Descripción	
Ambiental	Temperatura / Humedad de funcionamiento	-50°C ~ +55°C (-58°F ~ +131°F) / Menos del 90% de HR
	Temperatura / Humedad deprzechowywania	-50°C ~ +60°C (-58°F ~ +140°F) / Menos del 90% de HR
	Protección de ingreso	IP66
	A prueba de vandalismo	IK10
Eléctrico	Tensión/corriente de entrada	AC24V±10%
	Consumo de energía	90W(calentador On, IR ON), 60W(calentador Off, IR On)
Mecánico	Color / Material	Negro (cabezal) + marfil (cuerpo) / Plástico+metal
	Dimensiones (Ø x Al)	Ø236,9 x 407,7 mm
	Peso	7,1kg

## VISTA DEL PRODUCTO

Unidad : mm (pulg.)

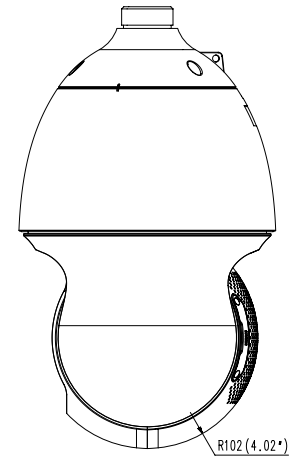
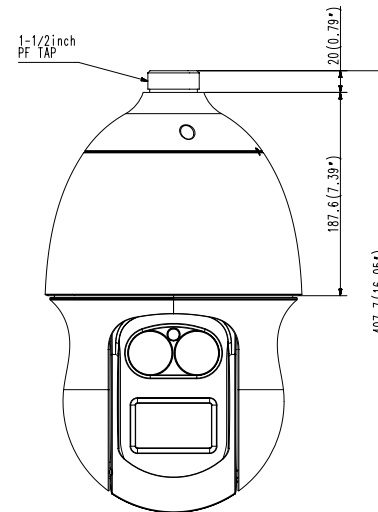
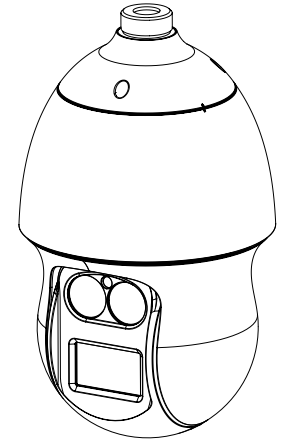
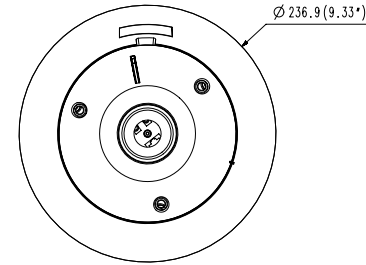

## SOLUCIÓN DE PROBLEMAS

PROBLEMA	SOLUCIÓN
El volumen del micrófono cambia con regularidad cuando se accede al visor web a través de Chrome o Firefox en Windows 10.	<ul style="list-style-type: none"> <li>Esto sucede cuando el driver del micrófono se configura en Realtek. Cámbialo al instalar el driver de dispositivo de audio High Definition (Driver predeterminado de Windows) o un driver de terceros.</li> </ul>
No se visualiza ningún video al acceder al visor web sin plug-in en Safari a través de HTTPS.	<ul style="list-style-type: none"> <li>En la ventana emergente de autenticación que aparece cuando se accede inicialmente a https, haga clic en "Ver certificado de autenticación" y seleccione la casilla "Confiar siempre al conectar con la IP del visor web designado".</li> <li>Si el visor web continúa sin mostrar un video después de seleccionar "Siguiente" en la ventana de mensaje siguiente, pulse la tecla de Comando + Q para salir del navegador Safari, obtenga acceso de nuevo y siga los procedimientos indicados anteriormente.</li> </ul>
No se puede acceder a la cámara desde un navegador web.	<ul style="list-style-type: none"> <li>Compruebe para asegurarse de que las configuraciones de Red de la cámara son las apropiadas.</li> <li>Compruebe para asegurarse de que todos los cables de red se han conectado bien.</li> <li>Si está conectado mediante DHCP, compruebe que la cámara puede admitir direcciones IP dinámicas sin problemas.</li> <li>Si la cámara está conectada al Enrutador de banda ancha, compruebe que el reenvío de puertos está configurado adecuadamente.</li> </ul>
El Visualizador se desconecta durante el control.	<ul style="list-style-type: none"> <li>Los Visualizadores conectados se desconectan debido a cualquier cambio en las configuraciones de cámara o de red.</li> <li>Compruebe todas las conexiones de red.</li> <li>Si la cámara está conectada por una red PPPoE, es posible que el Visualizador se desconecte con condiciones de red pobres.</li> </ul>
La cámara conectada a la red no se detecta en el programa del Device Manager.	<ul style="list-style-type: none"> <li>Apague las configuraciones de cortafuegos en su ordenador, y luego vuelva a buscar la cámara.</li> </ul>
Se superponen imágenes.	<ul style="list-style-type: none"> <li>Compruebe si dos o más cámaras están configuradas en una única dirección multicast en lugar de diferentes direcciones. Si se utiliza una única dirección para varias cámaras, las imágenes se pueden superponer.</li> </ul>
No aparece imagen.	<ul style="list-style-type: none"> <li>Si el método de transmisión está configurado como multicast, compruebe si hay un router que admita multicast en el LAN al que esté conectado la cámara.</li> </ul>

PROBLEMA	SOLUCIÓN
La grabación de audio no funciona aunque la entrada de audio está configurada.	<ul style="list-style-type: none"> <li>Ve a &lt;Básicos&gt;-&lt;Perfil de vídeo&gt; y comprobar el cuadro de la &lt;Entrada de audio&gt;.</li> </ul>
Después de configurar <Detección de movimiento> para <Activar> en <Analítica>, no se envía ningún archivo por e-mail aunque se haya producido un evento de analítica de vídeo en la cámara.	<ul style="list-style-type: none"> <li>Verifique los ajustes en la secuencia siguiente:                             <ol style="list-style-type: none"> <li>Compruebe los ajustes de &lt;Fecha y hora&gt;.</li> <li>&lt;Detección de movimiento&gt; debe definirse en &lt;Activar&gt;.</li> <li>Compruebe si la opción &lt;E-mail&gt; del menú &lt;Config. de evento&gt; está marcada para ser utilizada.</li> </ol> </li> </ul>
No se encuentra ninguna señal en el puerto de salida de alarma cuando se genera un evento de análisis de vídeo inteligente.	<ul style="list-style-type: none"> <li>Compruebe los ajustes del puerto de salida de alarma.</li> </ul>
No se puede grabar en la tarjeta de memoria SD.	<ul style="list-style-type: none"> <li>Compruebe si la tarjeta de memoria está defectuosa.</li> </ul>
La tarjeta de memoria SD está insertada pero no funciona correctamente.	<ul style="list-style-type: none"> <li>Compruebe si la tarjeta de memoria se ha insertado en la dirección correcta. En esta cámara, no se garantiza el funcionamiento de una tarjeta de memoria formateada con otros dispositivos</li> <li>Formatee de nuevo la tarjeta de memoria en el menú &lt;Config.&gt; → &lt;Evento&gt; → &lt;Almacenamiento&gt;.</li> </ul>
No se puede grabar en la NAS.	<ul style="list-style-type: none"> <li>Compruebe que la información registrada en la NAS es correcta.</li> </ul>
Se está indicando que la configuración de la NAS ha fallado.	<ul style="list-style-type: none"> <li>Compruebe que la dirección IP de NAS sea válida.</li> <li>Compruebe que el ID / contraseña de NAS sea válido</li> <li>Compruebe que puede acceder a la carpeta designada como la carpeta básica utilizando el ID de la NAS.</li> <li>Asegúrese de que los elementos SMB / CIFS de NAS estén sin marcar.</li> <li>Compruebe que la dirección IP de NAS y la dirección IP de la cámara tengan el mismo formato. Ejemplo) el valor inicial de la NAS y de la máscara de subred de la cámara es 255.255.255.0. Si la dirección IP es 192.168.20.32 entonces la dirección IP de NAS debe estar entre 192.168.20.1 y 192.168.20.255.</li> <li>Verifique si ha intentado acceder como otro usuario sin formatear la carpeta básica almacenada o usada.</li> <li>Compruebe que utilizó las unidades NAS recomendadas.</li> </ul>

# OPEN SOURCE ANNOUNCEMENT

## GPL/LGPL software license

The software included in this product contains copyrighted software that is licensed under the GPL/LGPL. You may obtain the complete Corresponding Source code from us for a period of three years after our last shipment of this product by sending email to [help.cctv@hanwha.com](mailto:help.cctv@hanwha.com)

If you want to obtain the complete Corresponding Source code in the physical medium such as CD-ROM, the cost of physically performing source distribution might be charged.

## GPL SW

Component Name	License	URL
Base Kernel	GPL 2.0	
Busybox	GPL 2.0	<a href="http://www.busybox.net/downloads/snapshots">http://www.busybox.net/downloads/snapshots</a>
iproute2-4.3.0	GPL 2.0	
iptables-1.4.21	GPL 2.0	<a href="http://ftp.netfilter.org/pub/iptables">http://ftp.netfilter.org/pub/iptables</a>
ethtool-4.2	GPL 2.0	
mtd-1.5.2	GPL 2.0	<a href="ftp://ftp.infradead.org/pub/mtd-utils">ftp://ftp.infradead.org/pub/mtd-utils</a>
mi-diag-2.11	GPL 2.0	
rp-pppoe-3.11	GPL 2.0	<a href="http://www.roaringpenguin.com/pppoe/">http://www.roaringpenguin.com/pppoe/</a>
wpa_supplicant-2.5	GPL 2.0	
bash-4.3.30	GPL 3.0	
zeroconf	GPL 2.0	

## LGPL SW

Component Name	License	URL
glibc	LGPL 2.0	
inetutils	LGPL 3.0	
neon-0.29.6	LGPL 2.0	<a href="http://www.webdav.org/neon/">http://www.webdav.org/neon/</a>

## GNU GENERAL PUBLIC LICENSE

Version 2, June 1991

Copyright (C) 1989, 1991 Free Software Foundation, Inc. 51 Franklin Street, Fifth Floor, Boston, MA 02110-1301, USA

Everyone is permitted to copy and distribute verbatim copies of this license document, but changing it is not allowed.

### Preamble

The licenses for most software are designed to take away your freedom to share and change it. By contrast, the GNU General Public License is intended to guarantee your freedom to share and change free software—to make sure the software is free for all its users. This General Public License applies to most of the Free Software Foundation's software and to any other program whose authors commit to using it. (Some other Free Software Foundation software is covered by the GNU Lesser General Public License instead.) You can apply it to your programs, too. When we speak of free software, we are referring to freedom, not price. Our General Public Licenses are designed to make sure that you have the freedom to distribute copies of free software (and charge for this service if you wish), that you receive source code or can get it if you want it, that you can change the software or use pieces of it in new free programs; and that you know you can do these things.

To protect your rights, we need to make restrictions that forbid anyone to deny you these rights or to ask you to surrender the rights. These restrictions translate to certain responsibilities for you if you distribute copies of the software, or if you modify it.

For example, if you distribute copies of such a program, whether gratis or for a fee, you must give the recipients all the rights that you have.

You must make sure that they, too, receive or can get the source code. And you must show them these terms so they know their rights. We protect your rights with two steps:

(1) Copyright the software, and (2) offer you this license which gives you legal permission to copy, distribute and/or modify the software. Also, for each author's protection and ours, we want to make certain that everyone understands that there is no warranty for this free software. If the software is modified by someone else and passed on, we want its recipients to know that what they have is not the original, so that any problems introduced by others will not reflect on the original authors' reputations.

Finally, any free program is threatened constantly by software patents. We wish to avoid the danger that redistributors of a free program will individually obtain patent licenses, in effect making the program proprietary. To prevent this, we have made it clear that any patent must be licensed for everyone's free use or not licensed at all. The precise terms and conditions for copying, distribution and modification follow.

### TERMS AND CONDITIONS FOR COPYING, DISTRIBUTION AND MODIFICATION

Version 2, June 1991 Copyright (C) 1989, 1991 Free Software Foundation, Inc. 51 Franklin St

0. This License applies to any program or other work which contains a notice placed by the copyright holder saying it may be distributed under the terms of this General Public License.

The "Program", below, refers to any such program or work, and a "work based on the Program" means either the Program or any derivative work under copyright law: that is to say, a work containing the Program or a portion of it, either verbatim or with modifications and/or translated into another language. (Hereinafter, translation is included without limitation in the term "modification".) Each licensee is addressed as "you".

Activities other than copying, distribution and modification are not covered by this License; they are outside its scope. The act of running the Program is not restricted, and the output from the Program is covered only if its contents constitute a work based on the Program (independent of having been made by running the Program). Whether that is true depends on what the Program does.

1. You may copy and distribute verbatim copies of the Program's source code as you receive it, in any medium, provided that you conspicuously and appropriately publish on each copy an appropriate copyright notice and disclaimer of warranty; keep intact all the notices that refer to this License and to the absence of any warranty; and give any other recipients of the Program a copy of this License along with the Program. You may charge a fee for the physical act of transferring a copy, and you may at your option offer warranty protection in exchange for a fee.
2. You may modify your copy or copies of the Program or any portion of it, thus forming a work based on the Program, and copy and distribute such modifications or work under the terms of Section 1 above, provided that you also meet all of these conditions:
  - a) You must cause the modified files to carry prominent notices stating that you changed the files and the date of any change.
  - b) You must cause any work that you distribute or publish, that in whole or in part contains or is derived from the Program or any part thereof, to be licensed as a whole at no charge to all third parties under the terms of this License.
  - c) If the modified program normally reads commands interactively when run, you must cause it, when started running for such interactive use in the most ordinary way, to print or display an announcement including an appropriate copyright notice and a notice that there is no warranty (or else, saying that you provide a warranty) and that users may redistribute the program under these conditions, and telling the user how to view a copy of this License. (Exception: if the Program itself is interactive but does not normally print such an announcement, your work based on the Program is not required to print an announcement.)

These requirements apply to the modified work as a whole. If identifiable sections of that work are not derived from the Program, and can be reasonably considered independent and separate works in themselves, then this License, and its terms, do not apply to those sections when you distribute them as separate works. But when you distribute the same sections as part of a whole which is a work based on the Program, the distribution of the whole must be on the terms of this License, whose permissions for other licensees extend to the entire whole, and thus to each and every part regardless of who wrote it.

Thus, it is not the intent of this section to claim rights or contest your rights to work written entirely by you; rather, the intent is to exercise the right to control the distribution of derivative or collective works based on the Program. In addition, mere aggregation of another work not based on the Program with the Program (or with a work based on the Program) on a volume of a storage or distribution medium does not bring the other work under the scope of this License.

3. You may copy and distribute the Program (or a work based on it, under Section 2) in object code or executable form under the terms of Sections 1 and 2 above provided that you also do one of the following:
  - a) Accompany it with the complete corresponding machine-readable source code, which must be distributed under the terms of Sections 1 and 2 above on a medium customarily used for software interchange; or,
  - b) Accompany it with a written offer, valid for at least three years, to give any third party, for a charge no more than your cost of physically performing source distribution, a complete machine-readable copy of the corresponding source code, to be distributed under the terms of Sections 1 and 2 above on a medium customarily used for software interchange; or,
  - c) Accompany it with the information you received as to the offer to distribute corresponding source code. (This alternative is allowed only for noncommercial distribution and only if you received the program in object code or executable form with such an offer, in accord with Subsection b above.) The source code for a work means the preferred form of the work for making modifications to it. For an executable work, complete source code means all the source code for all modules it contains, plus any associated interface definition files, plus the scripts used to control compilation and installation of the executable. However, as a special exception, the source code distributed need not include anything that is normally distributed (in either source or binary form) with the major

components (compiler, kernel, and so on) of the operating system on which the executable runs, unless that component itself accompanies the executable. If distribution of executable or object code is made by offering access to copy from a designated place, then offering equivalent access to copy the source code from the same place counts as distribution of the source code, even though third parties are not compelled to copy the source along with the object code.

4. You may not copy, modify, sublicense, or distribute the Program except as expressly provided under this License. Any attempt otherwise to copy, modify, sublicense or distribute the Program is void, and will automatically terminate your rights under this License.

However, parties who have received copies, or rights, from you under this License will not have their licenses terminated so long as such parties remain in full compliance.

5. You are not required to accept this License, since you have not signed it. However, nothing else grants you permission to modify or distribute the Program or its derivative works.

These actions are prohibited by law if you do not accept this License. Therefore, by modifying or distributing the Program (or any work based on the Program), you indicate your acceptance of this License to do so, and all its terms and conditions for copying, distributing or modifying the Program or works based on it.

6. Each time you redistribute the Program (or any work based on the Program), the recipient automatically receives a license from the original licensor to copy, distribute or modify the Program subject to these terms and conditions. You may not impose any further restrictions on the recipients' exercise of the rights granted herein. You are not responsible for enforcing compliance by third parties to this License.

7. If, as a consequence of a court judgment or allegation of patent infringement or for any other reason (not limited to patent issues), conditions are imposed on you (whether by court order, agreement or otherwise) that contradict the conditions of this License, they do not excuse you from the conditions of this License. If you cannot distribute so as to satisfy simultaneously your obligations under this License and any other pertinent obligations, then as a consequence you may not distribute the Program at all.

For example, if a patent license would not permit royalty-free redistribution of the Program by all those who receive copies directly or indirectly through you, then the only way you could satisfy both it and this License would be to refrain entirely from distribution of the Program.

If any portion of this section is held invalid or unenforceable under any particular circumstance, the balance of the section is intended to apply and the section as a whole is intended to apply in other circumstances. It is not the purpose of this section to induce you to infringe any patents or other property right claims or to contest validity of any such claims; this section has the sole purpose of protecting the integrity of the free software distribution system, which is implemented by public license practices. Many people have made generous contributions to the wide range of software distributed through that system in reliance on consistent application of that system; it is up to the author/donor to decide if he or she is willing to distribute software through any other system and a licensee cannot impose that choice. This section is intended to make thoroughly clear what is believed to be a consequence of the rest of this License.

8. If the distribution and/or use of the Program is restricted in certain countries either by patents or by copyrighted interfaces, the original copyright holder who places the Program under this License may add an explicit geographical distribution limitation excluding those countries, so that distribution is permitted only in or among countries not thus excluded. In such case, this License incorporates the limitation as if written in the body of this License.

9. The Free Software Foundation may publish revised and/or new versions of the General Public License from time to time. Such new versions will be similar in spirit to the present version, but may differ in detail to address new problems or concerns. Each version is given a distinguishing version number. If the Program specifies a version number of this License which applies to it and "any later version", you have the option of following the terms and conditions either of that version or of any later version published by the Free Software Foundation. If the Program does not specify a version number of this License, you may choose any version ever published by the Free Software Foundation.

10. If you wish to incorporate parts of the Program into other free programs whose distribution conditions are different, write to the author to ask for permission. For software which is copyrighted by the Free Software Foundation, write to the Free Software Foundation; we sometimes make exceptions for this. Our decision will be guided by the two goals of preserving the free status of all derivatives of our free software and of promoting the sharing and reuse of software generally.

## NO WARRANTY

11. BECAUSE THE PROGRAM IS LICENSED FREE OF CHARGE, THERE IS NO WARRANTY FOR THE PROGRAM, TO THE EXTENT PERMITTED BY APPLICABLE LAW. EXCEPT WHEN OTHERWISE STATED IN WRITING THE COPYRIGHT HOLDERS AND/OR OTHER PARTIES PROVIDE THE PROGRAM "AS IS" WITHOUT WARRANTY OF ANY KIND, EITHER EXPRESSED OR IMPLIED, INCLUDING, BUT NOT LIMITED TO, THE IMPLIED WARRANTIES OF MERCHANTABILITY AND FITNESS FOR A PARTICULAR PURPOSE. THE ENTIRE RISK AS TO THE QUALITY AND PERFORMANCE OF THE PROGRAM IS WITH YOU. SHOULD THE PROGRAM PROVE DEFECTIVE, YOU ASSUME THE COST OF ALL NECESSARY SERVICING, REPAIR OR CORRECTION.

12. IN NO EVENT UNLESS REQUIRED BY APPLICABLE LAW OR AGREED TO IN WRITING WILL ANY COPYRIGHT HOLDER, OR ANY OTHER PARTY WHO MAY MODIFY AND/OR REDISTRIBUTE DAMAGES, INCLUDING ANY GENERAL, SPECIAL, INCIDENTAL OR CONSEQUENTIAL DAMAGES ARISING OUT OF THE USE OR INABILITY TO USE THE PROGRAM (INCLUDING BUT NOT LIMITED TO LOSS OF DATA OR DATA BEING RENDERED INACCURATE OR LOSSES SUSTAINED BY YOU OR THIRD PARTIES OR A FAILURE OF THE PROGRAM TO OPERATE WITH ANY OTHER PROGRAMS), EVEN IF SUCH HOLDER OR OTHER PARTY HAS BEEN ADVISED OF THE POSSIBILITY OF SUCH DAMAGES.

## END OF TERMS AND CONDITIONS

How to Apply These Terms to Your New Programs If you develop a new program, and you want it to be of the greatest possible use to the public, the best way to achieve this is to make it free software which everyone can redistribute and change under these terms. To do so, attach the following notices to the program. It is safest to attach them to the start of each source file to most effectively convey the exclusion of warranty; and each file should have at least the "copyright" line and a pointer to where the full notice is found. One line to give the program's name and an idea of what it does.

Copyright (C)yyyy name of author

This program is free software; you can redistribute it and/or modify it under the terms of the GNU General Public License as published by the Free Software Foundation; either version 2 of the License, or (at your option) any later version.

This program is distributed in the hope that it will be useful, but WITHOUT ANY WARRANTY; without even the implied warranty of MERCHANTABILITY or FITNESS FOR A PARTICULAR PURPOSE. See the GNU General Public License for more details.

You should have received a copy of the GNU General Public License along with this program; if not, write to the Free Software Foundation, Inc., 51 Franklin Street, Fifth Floor, Boston, MA 02110-1301, USA.

Also add information on how to contact you by electronic and paper mail. If the program is interactive, make it output a short notice like this when it starts in an interactive mode:

Gnomovision version 69, Copyright (C) year name of author Gnomovision comes with ABSOLUTELY NO WARRANTY; for details type 'show w'. This is free software, and you are welcome to redistribute it under certain conditions; type 'show c' for details.

The hypothetical commands 'show w' and 'show c' should show the appropriate parts of the General Public License. Of course, the commands you use may be called something other than 'show w' and 'show c'; they could even be mouse-clicks or menu items - whatever suits your program.

You should also get your employer (if you work as a programmer) or your school, if any, to sign a "copyright disclaimer" for the program, if necessary. Here is a sample; alter the names:

Yoyodyne, Inc., hereby disclaims all copyright interest in the program 'Gnomovision' (which makes passes at compilers) written by James Hacker. signature of Ty Coon, 1 April 1989 Ty Coon, President of Vice This General Public License does not permit incorporating your program into proprietary programs. If your program is a subroutine library, you may consider it more useful to permit linking proprietary applications with the library. If this is what you want to do, use the GNU Lesser General Public License instead of this License.

## GNU GENERAL PUBLIC LICENSE

Version 3, 29 June 2007

Copyright (C) 2007 Free Software Foundation, Inc. <<http://fsf.org/>>

Everyone is permitted to copy and distribute verbatim copies of this license document, but changing it is not allowed.

### Preamble

The GNU General Public License is a free, copyleft license for software and other kinds of works. The licenses for most software and other practical works are designed to take away your freedom to share and change the works. By contrast, the GNU General Public License is intended to guarantee your freedom to share and change all versions of a program--to make sure it remains free software for all its users.

We, the Free Software Foundation, use the GNU General Public License for most of our software; it applies also to any other work released this way by its authors.

You can apply it to your programs, too. When we speak of free software, we are referring to freedom, not price. Our General Public Licenses are designed to make sure that you have the freedom to distribute copies of free software (and charge for them if you wish), that you receive source code or can get it if you want it, that you can change the software or use pieces of it in new free programs, and that you know you can do these things.

To protect your rights, we need to prevent others from denying you these rights or asking you to surrender the rights. Therefore, you have certain responsibilities if you distribute copies of the software, or if you modify it: responsibilities to respect the freedom of others. For example, if you distribute copies of such a program, whether gratis or for a fee, you must pass on to the recipients the same freedoms that you received. You must make sure that they, too, receive or can get the source code. And you must show them these terms so they know their rights. Developers that use the GNU GPL protect your rights with two steps: (1) assert copyright on the software, and (2) offer you this License giving you legal permission to copy, distribute and/or modify it. For the developers' and authors' protection, the GPL clearly explains that there is noarranty for this free software. For both users' and authors' sake, the GPL requires that modified versions be marked as changed, so that their problems will not be attributed erroneously to authors of previous versions. Some devices are designed to deny users access to install or run modified versions of the software inside them, although the manufacturer can do so. This is fundamentally incompatible with the aim of protecting users' freedom to change the software. The systematic pattern of such abuse occurs in the area of products for individuals to use, which is precisely where it is most unacceptable. Therefore, we have designed this version of the GPL to prohibit the practice for those products. If such problems arise substantially in other domains, we stand ready to extend this provision to those domains in future versions of the GPL, as needed to protect the freedom of users.

Finally, every program is threatened constantly by software patents. States should not allow patents to restrict development and use of software on general-purpose computers, but in those that do, we wish to avoid the special anger that patents applied to a free program could make it effectively proprietary. To prevent this, the GPL assures that patents cannot be used to render the program non-free. It precisely terms and conditions for copying, distribution and modification follow.

## TERMS AND CONDITIONS

### 0. Definitions.

"This License" refers to version 3 of the GNU General Public License.

"Copyright" also means copyright-like laws that apply to other kinds of works, such as semiconductor masks. "The Program" refers to any copyrightable work licensed under this License. Each licensee is addressed as "you". "Licensees" and "recipients" may be individuals or organizations.

To "modify" a work means to copy from or adapt all or part of the work in a fashion requiring copyright permission, other than the making of an exact copy. The resulting work is called a "modified version" of the earlier work or a work "based on" the earlier work.

A "covered work" means either the unmodified Program or a work based on the Program.

To "propagate" a work means to do anything with it that, without permission, would make you directly or secondarily liable for infringement under applicable copyright law, except executing it on a computer or modifying a private copy.

Propagation includes copying, distribution (with or without modification), making available to the public, and in some countries other activities as well.

To "convey" a work means any kind of propagation that enables other parties to make or receive copies. Mere interaction with a user through a computer network, with no transfer of a copy, is not conveying. An interactive user interface displays "Appropriate Legal Notices" to the extent that it includes a convenient and prominently visible feature that (1) displays an appropriate copyright notice, and (2) tells the user that there is no warranty for the work (except to the extent that warranties are provided), that licensees may convey the work under this License, and how to view a copy of this License. If the interface presents a list of user commands or options, such as a menu, a prominent item in the list meets this criterion.

### 1. Source Code.

The "source code" for a work means the preferred form of the work for making modifications to it. "Object code" means any non-source form of a work.

A "Standard Interface" means an interface that either is an official standard defined by a recognized standards body, or, in the case of interfaces specified for a particular programming language, one that is widely used among developers working in that language.

The "System Libraries" of an executable work include anything, other than the work as a whole, that (a) is included in the normal form of packaging a Major Component, but which is not part of that Major Component, and (b) serves only to enable use of the work with that Major Component, or to implement a Standard Interface for which an implementation is available to the public in source code form. A "Major Component", in this context, means a major essential component (kernel, window system, and so on) of the specific operating system (if any) on which the executable work runs, or a compiler used to produce the work, or an object code interpreter used to run it.

The "Corresponding Source" for a work in object code form means all the source code needed to generate, install, and (for an executable work) run the object code and to modify the work, including scripts to control those activities.

However, it does not include the work's System Libraries, or generalpurpose tools or generally available free programs which are used unmodified in performing those activities but which are not part of the work. For example, Corresponding Source includes interface definition files associated with source files for the work, and the source code for shared libraries and dynamically linked subprograms that the work is specifically designed to require, such as by intimate data communication or control flow between those subprograms and other parts of the work.

The Corresponding Source need not include anything that users can regenerate automatically from other parts of the Corresponding Source. The Corresponding Source for a work in source code form is that same work.

## 2. Basic Permissions.

All rights granted under this License are granted for the term of copyright on the Program, and are irrevocable provided the stated conditions are met. This License explicitly affirms your unlimited permission to run the unmodified Program. The output from running a covered work is covered by this License only if the output, given its content, constitutes a covered work. This License acknowledges your rights of fair use or other equivalent, as provided by copyright law.

You may make, run and propagate covered works that you do not convey, without conditions so long as your license otherwise remains in force. You may convey covered works to others for the sole purpose of having them make modifications exclusively for you, or provide you with facilities for running those works, provided that you comply with the terms of this License in conveying all material for which you do not control copyright. These thus making or running the covered works for you must do so exclusively on your behalf, under your direction and control, on terms that prohibit them from making any copies of your copyrighted material outside their relationship with you. Conveying under any other circumstances is permitted solely under the conditions stated below. Sublicensing is not allowed; section 10 makes it unnecessary.

## 3. Protecting Users' Legal Rights From anti-Circumvention Law.

No covered work shall be deemed part of an effective technological measure under any applicable law fulfilling obligations under article 11 of the WIPO copyright treaty adopted on 20 December 1996, or similar laws prohibiting or restricting circumvention of such measures.

When you convey a covered work, you waive any legal power to forbid circumvention of technological measures to the extent such circumvention is effected by exercising rights under this License with respect to the covered work, and you disclaim any intention to limit operation or modification of the work as a means of enforcing, against the work's users, your or third parties' legal rights to forbid circumvention of technological measures.

## 4. Conveying Verbatim Copies.

You may convey verbatim copies of the Program's source code as you receive it, in any medium, provided that you conspicuously and appropriately publish on each copy an appropriate copyright notice; keep intact all notices stating that this License and any non-permissive terms added in accord with section 7 apply to the code; keep intact all notices of the absence of any warranty; and give all recipients a copy of this License along with the Program. You may charge any price or no price for each copy that you convey, and you may offer support or warranty protection for a fee.

## 5. Conveying Modified Source Versions.

You may convey a work based on the Program, or the modifications to produce it from the Program, in the form of source code under the terms of section 4, provided that you also meet all of these conditions:

- The work must carry prominent notices stating that you modified it, and giving a relevant date.
- The work must carry prominent notices stating that it is released under this License and any conditions added under section 7. This requirement modifies the requirement in section 4 to "keep intact all notices".
- You must license the entire work, as a whole, under this License to anyone who comes into possession of a copy. This License will therefore apply, along with any applicable section 7 additional terms, to the whole of the work, and all its parts, regardless of how they are packaged. This License gives no permission to license the work in any other way, but it does not invalidate such permission if you have separately received it.
- If the work has interactive user interfaces, each must display Appropriate Legal Notices; however, if the Program has interactive interfaces that do not display Appropriate Legal Notices, your work need not make them do so. A compilation of a covered work with other separate and independent works, which are not by their nature extensions of the covered work, and which are not combined with it such as to form a larger program, in or on a volume of a storage or distribution medium, is called an "aggregate" if the compilation and its resulting copyright are not used to limit the access or legal rights of the compilation's users beyond what the individual works permit. Inclusion of a covered work in an aggregate does not cause this License to apply to the other parts of the aggregate.

## 6. Conveying Non-Source Forms.

You may convey a covered work in object code form under the terms of sections 4 and 5, provided that you also convey the machine-readable Corresponding Source under the terms of this License, in one of these ways:

- Convey the object code in, or embodied in, a physical product (including a physical distribution medium), accompanied by the Corresponding Source fixed on a durable physical medium customarily used for software interchange.
- Convey the object code in, or embodied in, a physical product (including a physical distribution medium), accompanied by a written offer, valid for at least three years and valid for as long as you offer spare parts or customer support for that product model, to give anyone who possesses the object code either (1) a copy of the Corresponding Source for all the software in the product that is covered by this License, on a durable physical medium customarily used for software interchange, for a price no more than your reasonable cost of physically performing this conveying of source, or (2) access to copy the Corresponding Source from a network server at no charge.
- Convey individual copies of the object code with a copy of the written offer to provide the corresponding Source. This alternative is allowed only occasionally and noncommercially, and only if you received the object code with such an offer, in accord with subsection 6b.
- Convey the object code by offering access from a designated place (gratis or for a charge), and offer equivalent access to the Corresponding Source in the same way through the same place at no further charge. You need not require recipients to copy the Corresponding Source along with the object code. If the place to copy the object code is a network server, the Corresponding Source may be on a different server (operated by you or a third party) that supports equivalent copying facilities, provided you maintain clear directions next to the object code saying where to find the Corresponding Source. Regardless of what server hosts the Corresponding Source, you remain obligated to ensure that it is available for as long as needed to satisfy these requirements.

- Convey the object code using peer-to-peer transmission, provided you inform other peers where the object code and Corresponding Source of the work are being offered to the general public at no charge under subsection 6d. A separable portion of the object code, whose source code is excluded from the Corresponding Source as a System Library, need not be included in conveying the object code work. A "User Product" is either (1) a "consumer product", which means any tangible personal property which is normally used for personal, family, or household purposes, or (2) anything designed or sold for incorporation into a dwelling. In determining whether a product is a consumer product, doubtful cases shall be resolved in favor of coverage. For a particular product received by a particular user, "normally used" refers to a typical or common use of that class of product, regardless of the status of the particular user or of the way in which the particular user actually uses, or expects or is expected to use, the product. A product is a consumer product regardless of whether the product has substantial commercial, industrial or non-consumer uses, unless such uses represent the only significant mode of use of the product.

"Installation Information" for a User Product means any methods, procedures, authorization keys, or other information required to install and execute modified versions of a covered work in that User Product from a modified version of its Corresponding Source. The information must suffice to ensure that the continued functioning of the modified object code is in no case prevented or interfered with solely because modification has been made. If you convey an object code work under this section in, or with, or specifically for use in, a User Product, and the conveying occurs as part of a transaction in which the right of possession and use of the User Product is transferred to the recipient in perpetuity or for a fixed term (regardless of how the transaction is characterized), the Corresponding Source conveyed under this section must be accompanied by the Installation Information. But this requirement does not apply if neither you nor any third party retains the ability to install modified object code on the User Product (for example, the work has been installed in ROM).

The requirement to provide Installation Information does not include a requirement to continue to provide support service, warranty, or updates for a work that has been modified or installed by the recipient, or for the User Product in which it has been modified or installed. Access to a network may be denied when the modification itself materially and adversely affects the operation of the network or violates the rules and protocols for communication across the network. Corresponding Source conveyed, and Installation Information provided, in accord with this section must be in a format that is publicly documented (and with an implementation available to the public in source code form), and must require no special password or key for unpacking, reading or copying.

## 7. Additional Terms.

"Additional permissions" are terms that supplement the terms of this License by making exceptions from one or more of its conditions. Additional permissions that are applicable to the entire Program shall be treated as though they were included in this License, to the extent that they are valid under applicable law. If additional permissions apply only to part of the Program, that part may be used separately under those permissions, but the entire Program remains governed by this License without regard to the additional permissions. When you convey a copy of a covered work, you may at your option remove any additional permissions from that copy, or from any part of it. (Additional permissions may be written to require their own removal in certain cases when you modify the work.) You may place additional permissions on material, added by you to a covered work, for which you have or can give appropriate copyright permission. Notwithstanding any other provision of this License, for material you add to a covered work, you may (if authorized by the copyright holders of that material) supplement the terms of this License with terms:

- Disclaiming warranty or limiting liability differently from the terms of sections 15 and 16 of this License; or
- Requiring preservation of specified reasonable legal notices or author attributions in that material or in the Appropriate Legal Notices displayed by works containing it; or
- Prohibiting misrepresentation of the origin of that material, or requiring that modified versions of such material be marked in reasonable ways as different from the original version; or
- Limiting the use for publicity purposes of names of licensors or authors of the material; or
- Declining to grant rights under trademark law for use of some trade names, trademarks, or service marks; or
- Requiring indemnification of licensors and authors of that material by anyone who conveys the material (or modified versions of it) with contractual assumptions of liability to the recipient, for any liability that these contractual assumptions directly impose on those licensors and authors. All other non-permissive additional terms are considered "further restrictions" within the meaning of section 10. If the Program as you received it, or any part of it, contains a notice stating that it is governed by this License along with a term that is a further restriction, you may remove that term. If a license document contains a further restriction but permits relicensing or conveying under this License, you may add to a covered work material governed by the terms of that license document, provided that the further restriction does not survive such relicensing or conveying. If you add terms to a covered work in accord with this section, you must place, in the relevant source files, a statement of the additional terms that apply to those files, or a notice indicating where to find the applicable terms. Additional terms, permissive or non-permissive, may be stated in the form of a separately written license, or stated as exceptions; the above requirements apply either way.

## 8. Termination.

You may not propagate or modify a covered work except as expressly provided under this License. Any attempt otherwise to propagate or modify it is void, and will automatically terminate your rights under this License (including any patent licenses granted under the third paragraph of section 11).

However, if you cease all violation of this License, then your license from a particular copyright holder is reinstated (a) provisionally, unless and until the copyright holder explicitly and finally terminates your license, and (b) permanently, if the copyright holder fails to notify you of the violation by some reasonable means prior to 60 days after the cessation. Moreover, your license from a particular copyright holder is reinstated permanently if the copyright holder notifies you of the violation by some reasonable means, this is the first time you have received notice of violation of this License for any work) from that copyright holder, and you cure the violation prior to 30 days after your receipt of the notice. Termination of your rights under this section does not terminate the licenses of parties who have received copies or rights from you under this License. If your rights have been terminated and not permanently reinstated, you do not qualify to receive new licenses for the same material under section 10.

## 9. Acceptance Not Required for Having Copies.

You are not required to accept this License in order to receive or run a copy of the Program. Ancillary propagation of a covered work occurring solely as a consequence of using peer-to-peer transmission to receive a copy likewise does not require acceptance. However, nothing other than this License grants you permission to propagate or modify any covered work. These actions infringe copyright if you do not accept this License. Therefore, by modifying or propagating a covered work, you indicate your acceptance of this License to do so.

## 10. Automatic Licensing of Downstream Recipients.

Each time you convey a covered work, the recipient automatically receives a license from the original licensors, to run, modify and propagate that work, subject to this License. You are not responsible for enforcing compliance by third parties with this License. An "entity transaction" is a transaction transferring control of an organization, or substantially all assets of one, or subdividing an organization, or merging organizations. If propagation of a covered work results from an entity transaction, each party to that transaction who receives a copy of the work also receives whatever licenses to the work the party's predecessor in interest had or could give under the previous paragraph, plus a right to possession of the Corresponding Source of the work from the predecessor in interest, if the predecessor has it or can get it with reasonable efforts. You may not impose any further restrictions on the exercise of the rights granted or affirmed under this License. For example, you may not impose a license fee, royalty, or other charge for exercise of rights granted under this License, and you may not initiate litigation (including a cross-claim or counterclaim in a lawsuit) alleging that any patent claim is infringed by making, using, selling, offering for sale, or importing the Program or any portion of it.

## 11. Patents.

A "contributor" is a copyright holder who authorizes use under this License of the Program or a work on which the Program is based. The work thus licensed is called the contributor's "contributor version". A contributor's "essential patent claims" are all patent claims owned or controlled by the contributor, whether already acquired or hereafter acquired, that would be infringed by some manner, permitted by this License, of making, using, or selling its contributor version, but do not include claims that would be infringed only as a consequence of further modification of the contributor version. For purposes of this definition, "control" includes the right to grant patent sublicenses in a manner consistent with the requirements of this License. Each contributor grants you a non-exclusive, worldwide, royalty-free patent license under the contributor's essential patent claims, to make, use, sell, offer for sale, import and otherwise run, modify and propagate the contents of its contributor version.

In the following three paragraphs, a "patent license" is any express agreement or commitment, however denominated, not to enforce a patent (such as an express permission to practice a patent or covenant not to sue for patent infringement). To "grant" such a patent license to a party means to make such an agreement or commitment not to enforce a patent against the party. If you convey a covered work, knowingly relying on a patent license, and the Corresponding Source of the work is not available for anyone to copy, free of charge and under the terms of this License, through a publicly available network server or other readily accessible means, then you must either (1) cause the Corresponding Source to be so available, or (2) arrange to deprive yourself of the benefit of the patent license for this particular work, or (3) arrange, in a manner consistent with the requirements of this License, to extend the patent license to downstream recipients. "Knowingly relying" means you have actual knowledge that, but for the patent license, your conveying the covered work in a country, or your recipient's use of the covered work in a country, would infringe one or more identifiable patents in that country that you have reason to believe are valid. If, pursuant to or in connection with a single transaction or arrangement, you convey, or propagate by procuring conveyance of, a covered work, and grant a

patent license to some of the parties receiving the covered work authorizing them to use, propagate, modify or convey a specific copy of the covered work, then the patent license you grant is automatically extended to all recipients of the covered work and works based on it. A patent license is "discriminatory" if it does not include within the scope of its coverage, prohibits the exercise of, or is conditioned on the non-exercise of one or more of the rights that are specifically granted under this License. You may not convey a covered work if you are a party to an arrangement with a third party that is in the business of distributing software, under which you make payment to the third party based on the extent of your activity of conveying the work, and under which the third party grants, to any of the parties who would receive the covered work from you, a discriminatory patent license

(a) in connection with copies of the covered work conveyed by you (or copies made from those copies), or

(b) primarily for and in connection with specific products or compilations that contain the covered work, unless you entered into that arrangement, or that patent license was granted, prior to 28 March 2007. Nothing in this License shall be construed as excluding or limiting any implied license or other defenses to infringement that may otherwise be available to you under applicable patent law.

#### 12. No Surrender of Others' Freedom.

If conditions are imposed on you (whether by court order, agreement or otherwise) that contradict the conditions of this License, they do not excuse you from the conditions of this License. If you cannot convey a covered work so as to satisfy simultaneously your obligations under this License and any other pertinent obligations, then as a consequence you may not convey it at all. For example, if you agree to terms that obligate you to collect a royalty for further conveying from those to whom you convey the Program, the only way you could satisfy both those terms and this License would be to refrain entirely from conveying the Program.

#### 13. Use with the GNU Affero General Public License.

Notwithstanding any other provision of this License, you have permission to link or combine any covered work with a work licensed under version 3 of the GNU Affero General Public License into a single combined work, and to convey the resulting work. The terms of this License will continue to apply to the part which is the covered work, but the special requirements of the GNU Affero General Public License, section 13, concerning interaction through a network will apply to the combination as such.

#### 14. Revised Versions of this License.

The Free Software Foundation may publish revised and/or new versions of the GNU General Public License from time to time. Such new versions will be similar in spirit to the present version, but may differ in detail to address new problems or concerns.

Each version is given a distinguishing version number. If the Program specifies that a certain numbered version of the GNU General Public License "or any later version" applies to it, you have the option of following the terms and conditions either of that numbered version or of any later version published by the Free Software Foundation. If the Program does not specify a version number of the GNU General Public License, you may choose any version ever published by the Free Software Foundation. If the Program specifies that a proxy can decide which future versions of the GNU General Public License can be used, that proxy's public statement of acceptance of a version permanently authorizes you to choose that version for the Program. Later license versions may give you additional or different permissions. However, no additional obligations are imposed on any author or copyright holder as a result of your choosing to follow a later version.

#### 15. Disclaimer of Warranty.

THERE IS NO WARRANTY FOR THE PROGRAM, TO THE EXTENT PERMITTED BY APPLICABLE LAW. EXCEPT WHEN OTHERWISE STATED IN WRITING THE COPYRIGHT HOLDERS AND/OR OTHER PARTIES PROVIDE THE PROGRAM "AS IS" WITHOUT WARRANTY OF ANY KIND, EITHER EXPRESSED OR IMPLIED, INCLUDING, BUT NOT LIMITED TO, THE IMPLIED WARRANTIES OF MERCHANTABILITY AND FITNESS FOR A PARTICULAR PURPOSE. THE ENTIRE RISK AS TO THE QUALITY AND PERFORMANCE OF THE PROGRAM IS WITH YOU. SHOULD THE PROGRAM PROVE DEFECTIVE, YOU ASSUME THE COST OF ALL NECESSARY SERVICING, REPAIR OR CORRECTION.

#### 16. Limitation of Liability.

IN NO EVENT UNLESS REQUIRED BY APPLICABLE LAW OR AGREED TO IN WRITING WILL ANY COPYRIGHT HOLDER, OR ANY OTHER PARTY WHO MODIFIES AND/OR CONVEYS THE PROGRAM AS PERMITTED ABOVE, BE LIABLE TO YOU FOR DAMAGES, INCLUDING ANY GENERAL, SPECIAL, INCIDENTAL OR CONSEQUENTIAL DAMAGES ARISING OUT OF THE USE OR INABILITY TO USE THE PROGRAM (INCLUDING BUT NOT LIMITED TO LOSS OF DATA OR DATA BEING RENDERED INACCURATE OR LOSSES SUSTAINED BY YOU OR THIRD PARTIES OR A FAILURE OF THE PROGRAM TO OPERATE WITH ANY OTHER PROGRAMS), EVEN IF SUCH HOLDER OR OTHER PARTY HAS BEEN ADVISED OF THE POSSIBILITY OF SUCH DAMAGES.

#### 17. Interpretation of Sections 15 and 16.

If the disclaimer of warranty and limitation of liability provided above cannot be given local legal effect according to their terms, reviewing courts shall apply local law that most closely approximates an absolute waiver of all civil liability in connection with the Program, unless a warranty or assumption of liability accompanies a copy of the Program in return for a fee.

## OpenSSL Combined License

The OpenSSL toolkit stays under a dual license, i.e. both the conditions of the OpenSSL License and the original SSLeay license apply to the toolkit.

See below for the actual license texts. Actually both licenses are BSD-style Open Source licenses. In case of any license issues related to OpenSSL please contact [openssl-core@openssl.org](mailto:openssl-core@openssl.org).

Component Name	License	URL
openssl-1.0.2g	OpenSSL	Combined License <a href="http://www.openssl.org/source">http://www.openssl.org/source</a>

Copyright (c) 1998-2016 The OpenSSL Project. All rights reserved.

Redistribution and use in source and binary forms, with or without modification, are permitted provided that the following conditions are met:

1. Redistributions of source code must retain the above copyright notice, this list of conditions and the following disclaimer.
2. Redistributions in binary form must reproduce the above copyright notice, this list of conditions and the following disclaimer in the documentation and/or other materials provided with the distribution.
3. All advertising materials mentioning features or use of this software must display the following acknowledgment: "This product includes software developed by the OpenSSL Project or use in the OpenSSL Toolkit. (<http://www.openssl.org/>)"
4. The names "OpenSSL Toolkit" and "OpenSSL Project" must not be used to endorse or promote products derived from this software without prior written permission. For written permission, please contact [openssl-core@openssl.org](mailto:openssl-core@openssl.org).
5. Products derived from this software may not be called "OpenSSL" nor may "OpenSSL" appear in their names without prior written permission of the OpenSSL Project.

6. Redistributions of any form whatsoever must retain the following acknowledgment: "This product includes software developed by the OpenSSL Project for use in the OpenSSL Toolkit (<http://www.openssl.org/>)"

THIS SOFTWARE IS PROVIDED BY THE OpenSSL PROJECT "AS IS" AND ANY EXPRESSED OR IMPLIED WARRANTIES, INCLUDING, BUT NOT LIMITED TO, THE IMPLIED WARRANTIES OF MERCHANTABILITY AND FITNESS FOR A PARTICULAR PURPOSE ARE DISCLAIMED. IN NO EVENT SHALL THE OpenSSL PROJECT OR ITS CONTRIBUTORS BE LIABLE FOR ANY DIRECT, INDIRECT, INCIDENTAL, SPECIAL, EXEMPLARY, OR CONSEQUENTIAL DAMAGES (INCLUDING, BUT NOT LIMITED TO, PROCUREMENT OF SUBSTITUTE GOODS OR SERVICES; LOSS OF USE, DATA, OR PROFITS; OR BUSINESS INTERRUPTION) HOWEVER CAUSED AND ON ANY THEORY OF LIABILITY, WHETHER IN CONTRACT, STRICT LIABILITY, OR TORT (INCLUDING NEGLIGENCE OR OTHERWISE) ARISING IN ANY WAY OUT OF THE USE OF THIS SOFTWARE, EVEN IF ADVISED OF THE POSSIBILITY OF SUCH DAMAGE.

This product includes cryptographic software written by Eric Young ([ey@cryptsoft.com](mailto:ey@cryptsoft.com)). This product includes software written by Tim Hudson ([tjh@cryptsoft.com](mailto:tjh@cryptsoft.com)).

#### Original SSLeay License

Copyright (C) 1995-1998 Eric Young ([ey@cryptsoft.com](mailto:ey@cryptsoft.com)) All rights reserved.

This package is an SSL implementation written by Eric Young ([ey@cryptsoft.com](mailto:ey@cryptsoft.com)).

The implementation was written so as to conform with Netscapes SSL.

This library is free for commercial and non-commercial use as long as the following conditions are adhered to. The following conditions apply to all code found in this distribution, be it the RC4, RSA, lhash, DES, etc., code; not just the SSL code. The SSL documentation included with this distribution is covered by the same copyright terms except that the holder is Tim Hudson ([tjh@cryptsoft.com](mailto:tjh@cryptsoft.com)).

Copyright remains Eric Young's, and as such any Copyright notices in the code are not to be removed. If this package is used in a product, Eric Young should be given attribution as the author of the parts of the library used. This can be in the form of a textual message at program startup or in documentation (online or textual) provided with the package. Redistribution and use in source and binary forms, with or without modification, are permitted provided that the following conditions are met:

1. Redistributions of source code must retain the copyright notice, this list of conditions and the following disclaimer.
2. Redistributions in binary form must reproduce the above copyright notice, this list of conditions and the following disclaimer in the documentation and/or other materials provided with the distribution.
3. All advertising materials mentioning features or use of this software must display the following acknowledgment: "This product includes cryptographic software written by Eric Young ([ey@cryptsoft.com](mailto:ey@cryptsoft.com))" The word "cryptographic" can be left out if the routines from the library being used are not cryptographic related :-).
4. If you include any Windows specific code (or a derivative thereof) from the apps directory (application code) you must include an acknowledgment: "This product includes software written by Tim Hudson ([tjh@cryptsoft.com](mailto:tjh@cryptsoft.com))"

THIS SOFTWARE IS PROVIDED BY ERIC YOUNG "AS IS" AND ANY EXPRESS OR IMPLIED WARRANTIES, INCLUDING, BUT NOT LIMITED TO, THE IMPLIED WARRANTIES OF MERCHANTABILITY AND FITNESS FOR A PARTICULAR PURPOSE ARE DISCLAIMED. IN NO EVENT SHALL THE AUTHOR OR CONTRIBUTORS BE LIABLE FOR ANY DIRECT, INDIRECT, INCIDENTAL, SPECIAL, EXEMPLARY, OR CONSEQUENTIAL DAMAGES (INCLUDING, BUT NOT LIMITED TO, PROCUREMENT OF SUBSTITUTE GOODS OR SERVICES; LOSS OF USE, DATA, OR PROFITS; OR BUSINESS INTERRUPTION) HOWEVER CAUSED AND ON ANY THEORY OF LIABILITY, WHETHER IN CONTRACT, STRICT LIABILITY, OR TORT (INCLUDING NEGLIGENCE OR OTHERWISE) ARISING IN ANY WAY OUT OF THE USE OF THIS SOFTWARE, EVEN IF ADVISED OF THE POSSIBILITY OF SUCH DAMAGE.

The license and distribution terms for any publicly available version or derivative of this code cannot be changed. i.e. this code cannot simply be copied and put under another distribution licence [including the GNU Public Licence.]

## BSD License

Some software components of this product incorporate source code covered under the BSD license as follows.

Component Name	License	URL
net-snmp-5.7.3	BSD	<a href="http://www.net-snmp.org/about/license.html">http://www.net-snmp.org/about/license.html</a>
pcrc-8.38	BSD	
libcap-1.7.4	BSD 2.0	<a href="http://www.kernel.org/pub/linux/libs/security/linux-privs/libcap2">http://www.kernel.org/pub/linux/libs/security/linux-privs/libcap2</a>
lighttpd-1.4.35	BSD 2.0	<a href="http://www.opensource.org/licenses/bsd-license.html">http://www.opensource.org/licenses/bsd-license.html</a>
MiniUPnP Project Client	BSD 2.0	
pppd-2.4.7	BSD 2.0	<a href="http://opensource.org/licenses/BSD-3-Clause">http://opensource.org/licenses/BSD-3-Clause</a>

lighttpd is a secure, fast, compliant, and very flexible webserver that has been optimized for high-performance environments. It has a very low memory footprint compared to other web servers and takes care of cpuload. Its advanced feature-set (FastCGI, CGI, Auth, Output-Compression, URL-Rewriting and many more) make lighttpd the perfect webserver software for every server that suffers load problems. Simple Network Management Protocol (SNMP) is an Internetstandard protocol for managing devices on IP networks. It is used mostly in network management systems to monitor the devices attached to the network for conditions that need administrative attention. Net-SNMP is a suite of applications used to implement SNMP v1, SNMP v2c and SNMP v3 using both IPv4 and IPv6. For more additional information, send email to [help.cct@hanwha.com](mailto:help.cct@hanwha.com).

Copyright (C) 2004, Kneschke, incremental

All rights reserved.

Redistribution and use in source and binary forms, with or without modification, are permitted provided that the following conditions are met :

- Redistributions of source code must retain the above copyright notice, this list of conditions and the following disclaimer.
- Redistributions in binary form must reproduce the above copyright notice, this list of conditions and the following disclaimer in the documentation and/or other materials provided with the distribution.
- Neither the name of the "incremental" nor the names of its contributors may be used to endorse or promote products derived from this software without specific prior written permission.



THIS SOFTWARE IS PROVIDED BY THE COPYRIGHT HOLDERS AND CONTRIBUTORS "AS IS" AND ANY EXPRESS OR IMPLIED WARRANTIES, INCLUDING, BUT NOT LIMITED TO, THE IMPLIED WARRANTIES OF MERCHANTABILITY AND FITNESS FOR A PARTICULAR PURPOSE ARE DISCLAIMED. IN NO EVENT SHALL THE COPYRIGHT OWNER OR CONTRIBUTORS BE LIABLE FOR ANY DIRECT, INDIRECT, INCIDENTAL, SPECIAL, EXEMPLARY, OR CONSEQUENTIAL DAMAGES (INCLUDING, BUT NOT LIMITED TO, PROCUREMENT OF SUBSTITUTE GOODS OR SERVICES; LOSS OF USE, DATA, OR PROFITS; OR BUSINESS INTERRUPTION) HOWEVER CAUSED AND ON ANY THEORY OF LIABILITY, WHETHER IN CONTRACT, STRICT LIABILITY, OR TORT (INCLUDING NEGLIGENCE OR OTHERWISE) ARISING IN ANY WAY OUT OF THE USE OF THIS SOFTWARE, EVEN IF ADVISED OF THE POSSIBILITY OF SUCH DAMAGE.

Copyright (c) 1998-2001 University College London

All rights reserved.

Redistribution and use in source and binary forms, with or without modification, is permitted provided that the following conditions are met :

1. Redistributions of source code must retain the above copyright notice, this list of conditions and the following disclaimer.
2. Redistributions in binary form must reproduce the above copyright notice, this list of conditions and the following disclaimer in the documentation and/or other materials provided with the distribution.
3. All advertising materials mentioning features or use of this software must display the following acknowledgement: This product includes software developed by the Computer Science Department at University College London.
4. Neither the name of the University nor of the Department may be used to endorse or promote products derived from this software without specific prior written permission.

THIS SOFTWARE IS PROVIDED BY THE AUTHORS AND CONTRIBUTORS "AS IS" AND ANY EXPRESSED OR IMPLIED WARRANTIES, INCLUDING, BUT NOT LIMITED TO, THE IMPLIED WARRANTIES OF MERCHANTABILITY AND FITNESS FOR A PARTICULAR PURPOSE ARE DISCLAIMED. IN NO EVENT SHALL THE AUTHORS OR CONTRIBUTORS BE LIABLE FOR ANY DIRECT, INDIRECT, INCIDENTAL, SPECIAL, EXEMPLARY, OR CONSEQUENTIAL DAMAGES (INCLUDING, BUT NOT LIMITED TO, PROCUREMENT OF SUBSTITUTE GOODS OR SERVICES; LOSS OF USE, DATA, OR PROFITS; OR BUSINESS INTERRUPTION) HOWEVER CAUSED AND ON ANY THEORY OF LIABILITY, WHETHER IN CONTRACT, STRICT LIABILITY, OR TORT (INCLUDING NEGLIGENCE OR OTHERWISE) ARISING IN ANY WAY OUT OF THE USE OF THIS SOFTWARE, EVEN IF ADVISED OF THE POSSIBILITY OF SUCH DAMAGE.

Copyright (c) 1988, 1989, 1990, 1991, 1993, 1994, 1995, 1996 The Regents of the University of California.

All rights reserved.

Redistribution and use in source and binary forms, with or without modification, are permitted provided that the following conditions are met:

1. Redistributions of source code must retain the above copyright notice, this list of conditions and the following disclaimer.
2. Redistributions in binary form must reproduce the above copyright notice, this list of conditions and the following disclaimer in the documentation and/or other materials provided with the distribution.
3. Neither the name of the Regents of the University of California nor the names of its contributors may be used to endorse or promote products derived from this software without specific prior written permission.

THIS SOFTWARE IS PROVIDED BY THE COPYRIGHT HOLDERS AND CONTRIBUTORS "AS IS" AND ANY EXPRESS OR IMPLIED WARRANTIES, INCLUDING, BUT NOT LIMITED TO, THE IMPLIED WARRANTIES OF MERCHANTABILITY AND FITNESS FOR A PARTICULAR PURPOSE ARE DISCLAIMED. IN NO EVENT SHALL THE COPYRIGHT OWNER OR CONTRIBUTORS BE LIABLE FOR ANY DIRECT, INDIRECT, INCIDENTAL, SPECIAL, EXEMPLARY, OR CONSEQUENTIAL DAMAGES (INCLUDING, BUT NOT LIMITED TO, PROCUREMENT OF SUBSTITUTE GOODS OR SERVICES; LOSS OF USE, DATA, OR PROFITS; OR BUSINESS INTERRUPTION) HOWEVER CAUSED AND ON ANY THEORY OF LIABILITY, WHETHER IN CONTRACT, STRICT LIABILITY, OR TORT (INCLUDING NEGLIGENCE OR OTHERWISE) ARISING IN ANY WAY OUT OF THE USE OF THIS SOFTWARE, EVEN IF ADVISED OF THE POSSIBILITY OF SUCH DAMAGE.

Copyright (c) 2006, Creative Labs Inc

All rights reserved.

Redistribution and use in source and binary forms, with or without modification, are permitted provided that the following conditions are met:

1. Redistributions of source code must retain the above copyright notice, this list of conditions and the following disclaimer.
2. Redistributions in binary form must reproduce the above copyright notice, this list of conditions and the following disclaimer in the documentation and/or other materials provided with the distribution.
3. Neither the name of the Creative Labs nor the names of its contributors may be used to endorse or promote products derived from this software without specific prior written permission.

THIS SOFTWARE IS PROVIDED BY THE COPYRIGHT HOLDERS AND CONTRIBUTORS "AS IS" AND ANY EXPRESS OR IMPLIED WARRANTIES, INCLUDING, BUT NOT LIMITED TO, THE IMPLIED WARRANTIES OF MERCHANTABILITY AND FITNESS FOR A PARTICULAR PURPOSE ARE DISCLAIMED. IN NO EVENT SHALL THE COPYRIGHT OWNER OR CONTRIBUTORS BE LIABLE FOR ANY DIRECT, INDIRECT, INCIDENTAL, SPECIAL, EXEMPLARY, OR CONSEQUENTIAL DAMAGES (INCLUDING, BUT NOT LIMITED TO, PROCUREMENT OF SUBSTITUTE GOODS OR SERVICES; LOSS OF USE, DATA, OR PROFITS; OR BUSINESS INTERRUPTION) HOWEVER CAUSED AND ON ANY THEORY OF LIABILITY, WHETHER IN CONTRACT, STRICT LIABILITY, OR TORT (INCLUDING NEGLIGENCE OR OTHERWISE) ARISING IN ANY WAY OUT OF THE USE OF THIS SOFTWARE, EVEN IF ADVISED OF THE POSSIBILITY OF SUCH DAMAGE.

Copyright (c) 2005-2012, Thomas BERNARD

All rights reserved.

Redistribution and use in source and binary forms, with or without modification, are permitted provided that the following conditions are met:

1. Redistributions of source code must retain the above copyright notice, this list of conditions and the following disclaimer.
2. Redistributions in binary form must reproduce the above copyright notice, this list of conditions and the following disclaimer in the documentation and/or other materials provided with the distribution.
3. Neither the name of Thomas BERNARD nor the names of its contributors may be used to endorse or promote products derived from this software without specific prior written permission.

THIS SOFTWARE IS PROVIDED BY THE COPYRIGHT HOLDERS AND CONTRIBUTORS "AS IS" AND ANY EXPRESS OR IMPLIED WARRANTIES, INCLUDING, BUT NOT LIMITED TO, THE IMPLIED WARRANTIES OF MERCHANTABILITY AND FITNESS FOR A PARTICULAR PURPOSE ARE DISCLAIMED. IN NO EVENT SHALL THE COPYRIGHT OWNER OR CONTRIBUTORS BE LIABLE FOR ANY DIRECT, INDIRECT, INCIDENTAL, SPECIAL, EXEMPLARY, OR CONSEQUENTIAL DAMAGES (INCLUDING, BUT NOT LIMITED TO, PROCUREMENT OF SUBSTITUTE GOODS OR SERVICES; LOSS OF USE, DATA, OR PROFITS; OR BUSINESS INTERRUPTION) HOWEVER CAUSED AND ON ANY THEORY OF LIABILITY, WHETHER IN CONTRACT, STRICT LIABILITY, OR

TORT (INCLUDING NEGLIGENCE OR OTHERWISE) ARISING IN ANY WAY OUT OF THE USE OF THIS SOFTWARE, EVEN IF ADVISED OF THE POSSIBILITY OF SUCH DAMAGE.

Various copyrights apply to this package, listed in various separate parts below. Please make sure that you read all the parts.

#### **Part 1 : CMU/UCD copyright notice: (BSD like)**

Copyright 1989, 1991, 1992 by Carnegie Mellon University Derivative Work - 1996, 1998-2000

Copyright 1996, 1998-2000 The Regents of the University of California

All Rights Reserved

Permission to use, copy, modify and distribute this software and its documentation for any purpose and without fee is hereby granted, provided that the above copyright notice appears in all copies and that both that copyright notice and this permission notice appear in supporting documentation, and that the name of CMU and The Regents of the University of California not be used in advertising or publicity pertaining to distribution of the software without specific written permission.

CMU AND THE REGENTS OF THE UNIVERSITY OF CALIFORNIA DISCLAIM ALL WARRANTIES WITH REGARD TO THIS SOFTWARE, INCLUDING ALL IMPLIED WARRANTIES OF MERCHANTABILITY AND FITNESS. IN NO EVENT SHALL CMU OR THE REGENTS OF THE UNIVERSITY OF CALIFORNIA BE LIABLE FOR ANY SPECIAL, INDIRECT OR CONSEQUENTIAL DAMAGES OR OTHER DAMAGES WHATSOEVER RESULTING FROM THE LOSS OF USE, DATA OR PROFITS, WHETHER IN AN ACTION OF CONTRACT, NEGLIGENCE OR OTHER TORTIOUS ACTION, ARISING OUT OF OR IN CONNECTION WITH THE USE OR PERFORMANCE OF THIS SOFTWARE.

#### **Part 2 : Networks Associates Technology, Inc copyright notice (BSD)**

Copyright (c) 2001-2003, Networks Associates Technology, Inc

All rights reserved.

Redistribution and use in source and binary forms, with or without modification, are permitted provided that the following conditions are met: yy Redistributions of source code must retain the above copyright notice, this list of conditions and the following disclaimer. yy Redistributions in binary form must reproduce the above copyright notice, this list of conditions and the following disclaimer in the documentation and/or other materials provided with the distribution. yy Neither the name of the Networks Associates Technology, Inc nor the names of its contributors may be used to endorse or promote products derived from this software without specific prior written permission.

THIS SOFTWARE IS PROVIDED BY THE COPYRIGHT HOLDERS AND CONTRIBUTORS "AS IS" AND ANY EXPRESS OR IMPLIED WARRANTIES, INCLUDING, BUT NOT LIMITED TO, THE IMPLIED WARRANTIES OF MERCHANTABILITY AND FITNESS FOR A PARTICULAR PURPOSE ARE DISCLAIMED. IN NO EVENT SHALL THE COPYRIGHT HOLDERS OR CONTRIBUTORS BE LIABLE FOR ANY DIRECT, INDIRECT, INCIDENTAL, SPECIAL, EXEMPLARY, OR CONSEQUENTIAL DAMAGES (INCLUDING, BUT NOT LIMITED TO, PROCUREMENT OF SUBSTITUTE GOODS OR SERVICES; LOSS OF USE, DATA, OR PROFITS; OR BUSINESS INTERRUPTION) HOWEVER CAUSED AND ON ANY THEORY OF LIABILITY, WHETHER IN CONTRACT, STRICT LIABILITY, OR TORT (INCLUDING NEGLIGENCE OR OTHERWISE) ARISING IN ANY WAY OUT OF THE USE OF THIS SOFTWARE, EVEN IF ADVISED OF THE POSSIBILITY OF SUCH DAMAGE.

#### **Part 3 : Cambridge Broadband Ltd. copyrightnotice (BSD)**

Portions of this code are copyright (c) 2001-2003, Cambridge Broadband Ltd.

All rights reserved.

Redistribution and use in source and binary forms, with or without modification, are permitted provided that the following conditions are met: yy Redistributions of source code must retain the above copyright notice, this list of conditions and the following disclaimer. yy Redistributions in binary form must reproduce the above copyright notice, this list of conditions and the following disclaimer in the documentation and/or other materials provided with the distribution. yy The name of Cambridge Broadband Ltd. may not be used to endorse or promote products derived from this software without specific prior written permission.

THIS SOFTWARE IS PROVIDED BY THE COPYRIGHT HOLDER "AS IS" AND ANY EXPRESS OR IMPLIED WARRANTIES, INCLUDING, BUT NOT LIMITED TO, THE IMPLIED WARRANTIES OF MERCHANTABILITY AND FITNESS FOR A PARTICULAR PURPOSE ARE DISCLAIMED. IN NO EVENT SHALL THE COPYRIGHT HOLDER BE LIABLE FOR ANY DIRECT, INDIRECT, INCIDENTAL, SPECIAL, EXEMPLARY, OR CONSEQUENTIAL DAMAGES (INCLUDING, BUT NOT LIMITED TO, PROCUREMENT OF SUBSTITUTE GOODS OR SERVICES; LOSS OF USE, DATA, OR PROFITS; OR BUSINESS INTERRUPTION) HOWEVER CAUSED AND ON ANY THEORY OF LIABILITY, WHETHER IN CONTRACT, STRICT LIABILITY, OR TORT (INCLUDING NEGLIGENCE OR OTHERWISE) ARISING IN ANY WAY OUT OF THE USE OF THIS SOFTWARE, EVEN IF ADVISED OF THE POSSIBILITY OF SUCH DAMAGE.

#### **Part 4 : Sun Microsystems, Inc. copyright notice**

(BSD)

Copyright (c) 2003 Sun Microsystems, Inc., 4150 Network

Circle, Santa Clara, California 95054, U.S.A.

All rights reserved.

Use is subject to license terms below. This distribution may include materials developed by third parties. Sun, Sun Microsystems, the Sun logo and Solaris are trademarks or registered trademarks of Sun Microsystems, Inc. in the U.S. and other countries. Redistribution and use in source and binary forms, with or without modification, are permitted provided that the following conditions are met: yy Redistributions of source code must retain the above copyright notice, this list of conditions and the following disclaimer. yy Redistributions in binary form must reproduce the above copyright notice, this list of conditions and the following disclaimer in the documentation and/or other materials provided with the distribution. yy Neither the name of the Sun Microsystems, Inc. nor the names of its contributors may be used to endorse or promote products derived from this software without specific prior written permission.

THIS SOFTWARE IS PROVIDED BY THE COPYRIGHT HOLDERS AND CONTRIBUTORS "AS IS" AND ANY EXPRESS OR IMPLIED WARRANTIES, INCLUDING, BUT NOT LIMITED TO, THE IMPLIED WARRANTIES OF MERCHANTABILITY AND FITNESS FOR A PARTICULAR PURPOSE ARE DISCLAIMED. IN NO EVENT SHALL THE COPYRIGHT HOLDERS OR CONTRIBUTORS BE LIABLE FOR ANY DIRECT, INDIRECT, INCIDENTAL, SPECIAL, EXEMPLARY, OR CONSEQUENTIAL DAMAGES (INCLUDING, BUT NOT LIMITED TO, PROCUREMENT OF SUBSTITUTE GOODS OR SERVICES; LOSS OF USE, DATA, OR PROFITS; OR BUSINESS INTERRUPTION) HOWEVER CAUSED AND ON ANY THEORY OF LIABILITY, WHETHER IN CONTRACT, STRICT LIABILITY, OR TORT (INCLUDING NEGLIGENCE OR OTHERWISE) ARISING IN ANY WAY OUT OF THE USE OF THIS SOFTWARE, EVEN IF ADVISED OF THE POSSIBILITY OF SUCH DAMAGE.

#### **Part 5 : Sparta, Inc copyright notice (BSD)**

Copyright (c) 2003-2009, Sparta, Inc

All rights reserved.

Redistribution and use in source and binary forms, with or without modification, are permitted provided that the following conditions are met: yy Redistributions of source code must retain the above copyright notice, this list of conditions and the following disclaimer. yy Redistributions in binary form must reproduce the

above copyright notice, this list of conditions and the following disclaimer in the documentation and/or other materials provided with the distribution. yy Neither the name of Sparta, Inc nor the names of its contributors may be used to endorse or promote products derived from this software without specific prior written permission.

THIS SOFTWARE IS PROVIDED BY THE COPYRIGHT HOLDERS AND CONTRIBUTORS "AS IS" AND ANY EXPRESS OR IMPLIED WARRANTIES, INCLUDING, BUT NOT LIMITED TO, THE IMPLIED WARRANTIES OF MERCHANTABILITY AND FITNESS FOR A PARTICULAR PURPOSE ARE DISCLAIMED. IN NO EVENT SHALL THE COPYRIGHT HOLDERS OR CONTRIBUTORS BE LIABLE FOR ANY DIRECT, INDIRECT, INCIDENTAL, SPECIAL, EXEMPLARY, OR CONSEQUENTIAL DAMAGES (INCLUDING, BUT NOT LIMITED TO, PROCUREMENT OF SUBSTITUTE GOODS OR SERVICES; LOSS OF USE, DATA, OR PROFITS; OR BUSINESS INTERRUPTION) HOWEVER CAUSED AND ON ANY THEORY OF LIABILITY, WHETHER IN CONTRACT, STRICT LIABILITY, OR TORT (INCLUDING NEGLIGENCE OR OTHERWISE) ARISING IN ANY WAY OUT OF THE USE OF THIS SOFTWARE, EVEN IF ADVISED OF THE POSSIBILITY OF SUCH DAMAGE.

#### Part 6: Cisco/BUPTNIC copyright notice (BSD)

Copyright (c) 2004, Cisco, Inc and Information Network

Center of Beijing University of Posts and Telecommunications.

All rights reserved.

Redistribution and use in source and binary forms, with or without modification, are permitted provided that the following conditions are met: yy Redistributions of source code must retain the above copyright notice, this list of conditions and the following disclaimer. yy Redistributions in binary form must reproduce the above copyright notice, this list of conditions and the following disclaimer in the documentation and/or other materials provided with the distribution. yy Neither the name of Cisco, Inc, Beijing University of Posts and Telecommunications, nor the names of their contributors may be used to endorse or promote products derived from this software without specific prior written permission.

THIS SOFTWARE IS PROVIDED BY THE COPYRIGHT HOLDERS AND CONTRIBUTORS "AS IS" AND ANY EXPRESS OR IMPLIED WARRANTIES, INCLUDING, BUT NOT LIMITED TO, THE IMPLIED WARRANTIES OF MERCHANTABILITY AND FITNESS FOR A PARTICULAR PURPOSE ARE DISCLAIMED. IN NO EVENT SHALL THE COPYRIGHT HOLDERS OR CONTRIBUTORS BE LIABLE FOR ANY DIRECT, INDIRECT, INCIDENTAL, SPECIAL, EXEMPLARY, OR CONSEQUENTIAL DAMAGES (INCLUDING, BUT NOT LIMITED TO, PROCUREMENT OF SUBSTITUTE GOODS OR SERVICES; LOSS OF USE, DATA, OR PROFITS; OR BUSINESS INTERRUPTION) HOWEVER CAUSED AND ON ANY THEORY OF LIABILITY, WHETHER IN CONTRACT, STRICT LIABILITY, OR TORT (INCLUDING NEGLIGENCE OR OTHERWISE) ARISING IN ANY WAY OUT OF THE USE OF THIS SOFTWARE, EVEN IF ADVISED OF THE POSSIBILITY OF SUCH DAMAGE.

#### Part 7: Fabasoft R&D Software Software GmbH & Co KG copyright Notice (BSD)

Copyright (c) Fabasoft R&D Software GmbH & Co KG, 2003oss@fabasoft.com

Author: Bernhard Penz

Redistribution and use in source and binary forms, with or without modification, are permitted provided that the following conditions are met: yy Redistributions of source code must retain the above copyright notice, this list of conditions and the following disclaimer. yy Redistributions in binary form must reproduce the above copyright notice, this list of conditions and the following disclaimer in the documentation and/or other materials provided with the distribution. yy The name of Fabasoft R&D Software GmbH & Co KG or any of its subsidiaries, brand or product names may not be used to endorse or promote products derived from this software without specific prior written permission.

THIS SOFTWARE IS PROVIDED BY THE COPYRIGHT HOLDER "AS IS" AND ANY EXPRESS OR IMPLIED WARRANTIES, INCLUDING, BUT NOT LIMITED TO, THE IMPLIED WARRANTIES OF MERCHANTABILITY AND FITNESS FOR A PARTICULAR PURPOSE ARE DISCLAIMED. IN NO EVENT SHALL THE COPYRIGHT HOLDER BE LIABLE FOR ANY DIRECT, INDIRECT, INCIDENTAL, SPECIAL, EXEMPLARY, OR CONSEQUENTIAL DAMAGES (INCLUDING, BUT NOT LIMITED TO, PROCUREMENT OF SUBSTITUTE GOODS OR SERVICES; LOSS OF USE, DATA, OR PROFITS; OR BUSINESS INTERRUPTION) HOWEVER CAUSED AND ON ANY THEORY OF LIABILITY, WHETHER IN CONTRACT, STRICT LIABILITY, OR TORT (INCLUDING NEGLIGENCE OR OTHERWISE) ARISING IN ANY WAY OUT OF THE USE OF THIS SOFTWARE, EVEN IF ADVISED OF THE POSSIBILITY OF SUCH DAMAGE.

#### Part 8: Apple Inc. copyright notice (BSD)

Copyright (c) 2007 Apple Inc.

All rights reserved.

Redistribution and use in source and binary forms, with or without modification, are permitted provided that the following conditions are met:

1. Redistributions of source code must retain the above copyright notice, this list of conditions and the following disclaimer.
2. Redistributions in binary form must reproduce the above copyright notice, this list of conditions and the following disclaimer in the documentation and/or other materials provided with the distribution. 3. Neither the name of Apple Inc. ("Apple") nor the names of its contributors may be used to endorse or promote products derived from this software without specific prior written permission.

THIS SOFTWARE IS PROVIDED BY APPLE AND ITS CONTRIBUTORS "AS IS" AND ANY EXPRESS OR IMPLIED WARRANTIES, INCLUDING, BUT NOT LIMITED TO, THE IMPLIED WARRANTIES OF MERCHANTABILITY AND FITNESS FOR A PARTICULAR PURPOSE ARE DISCLAIMED. IN NO EVENT SHALL APPLE OR ITS CONTRIBUTORS BE LIABLE FOR ANY DIRECT, INDIRECT, INCIDENTAL, SPECIAL, EXEMPLARY, OR CONSEQUENTIAL DAMAGES (INCLUDING, BUT NOT LIMITED TO, PROCUREMENT OF SUBSTITUTE GOODS OR SERVICES; LOSS OF USE, DATA, OR PROFITS; OR BUSINESS INTERRUPTION) HOWEVER CAUSED AND ON ANY THEORY OF LIABILITY, WHETHER IN CONTRACT, STRICT LIABILITY, OR TORT (INCLUDING NEGLIGENCE OR OTHERWISE) ARISING IN ANY WAY OUT OF THE USE OF THIS SOFTWARE, EVEN IF ADVISED OF THE POSSIBILITY OF SUCH DAMAGE.

#### Part 9: ScienceLogic, LLC copyright notice(BSD)

Copyright (c) 2009, ScienceLogic, LLC

All rights reserved.

Redistribution and use in source and binary forms, with or without modification, are permitted provided that the following conditions aremet: yy Redistributions of source code must retain the above copyright notice, this list of conditions and the following disclaimer. yy Redistributions in binary form must reproduce the above copyright notice, this list of conditions and the following disclaimer in the documentation and/or other materials provided with the distribution. yy Neither the name of ScienceLogic, LLC nor the names of its contributors may be used to endorse or promote products derived from this software without specific prior written permission.

THIS SOFTWARE IS PROVIDED BY THE COPYRIGHT HOLDERS AND CONTRIBUTORS "AS IS" AND ANY EXPRESS OR IMPLIED WARRANTIES, INCLUDING, BUT NOT LIMITED TO, THE IMPLIED WARRANTIES OF MERCHANTABILITY AND FITNESS FOR A PARTICULAR PURPOSE ARE DISCLAIMED. IN NO EVENT SHALL THE COPYRIGHT HOLDERS OR CONTRIBUTORS BE LIABLE FOR ANY DIRECT, INDIRECT, INCIDENTAL, SPECIAL, EXEMPLARY, OR CONSEQUENTIAL DAMAGES (INCLUDING, BUT NOT LIMITED TO, PROCUREMENT OF SUBSTITUTE GOODS OR SERVICES; LOSS OF USE, DATA, OR PROFITS; OR BUSINESS INTERRUPTION) HOWEVER CAUSED AND ON ANY THEORY OF LIABILITY, WHETHER IN CONTRACT, STRICT LIABILITY, OR TORT (INCLUDING NEGLIGENCE OR OTHERWISE) ARISING IN ANY WAY OUT OF THE USE OF THIS SOFTWARE, EVEN IF ADVISED OF THE POSSIBILITY OF SUCH DAMAGE

## The MIT License

Some software components of this product incorporate source code covered under the MIT license as follows

### MIT License 2.0

- Acedwidet, bettermeans, jquery-ui, libxml, libxml2, Mesa3D-MesaLib,mwEmbed,OpenGL Samples Pack, Wide Studio, xorg-server, dropbear-2012.55, ncurses-5.7

Copyright (c) 2011, The Dojo Foundation

Copyright 2010, AUTHORS.txt (<http://jqueryui.com/about>)

Dual licensed under the MIT or GPL Version 2 licenses.

- <http://jquery.org/license>

- <http://docs.jquery.com/UI/Widget>

Copyright Daniel Veillard

Copyright Igor Zlatovic <[igor@zlatkovic.com](mailto:igor@zlatkovic.com)>

Copyright Aleksey Sanin

Copyright Gary Pennington <[Gary.Pennington@uk.sun.com](mailto:Gary.Pennington@uk.sun.com)>

Copyright Alfred Mickautsch <[alfred@mickautsch.de](mailto:alfred@mickautsch.de)>

Copyright Bjorn Reese <[bjorn.reese@systematic.dk](mailto:bjorn.reese@systematic.dk)>

Copyright Joel W. Reed

Copyright William Brack <[wbrack@mmm.com.hk](mailto:wbrack@mmm.com.hk)>

Copyright (c) 2007-2010 The Khronos Group Inc.

Copyright Atish Kumar Patra

Copyright (c) 2006 Free Software Foundation, Inc.

Permission is hereby granted, free of charge, to any person obtaining a copy of this software and associated documentation files (the "Software"), to deal in the Software without restriction, including without limitation the rights to use, copy, modify, merge, publish, distribute, sublicense, and/or sell copies of the Software, and to permit persons to whom the Software is furnished to do so, subject to the following conditions:

The above copyright notice and this permission notice shall be included in all copies or substantial portions of the Software.

THE SOFTWARE IS PROVIDED "AS IS", WITHOUT WARRANTY OF ANY KIND, EXPRESS OR IMPLIED, INCLUDING BUT NOT LIMITED TO THE WARRANTIES OF MERCHANTABILITY, FITNESS FOR A PARTICULAR PURPOSE AND NONINFRINGEMENT. IN NO EVENT SHALL THE AUTHORS OR COPYRIGHT HOLDERS BE LIABLE FOR ANY CLAIM, DAMAGES OR OTHER LIABILITY, WHETHER IN AN ACTION OF CONTRACT, TORT OR OTHERWISE, ARISING FROM, OUT OF OR IN CONNECTION WITH THE SOFTWARE OR THE USE OR OTHER DEALINGS IN THE SOFTWARE.

## Mozilla Public License

Since we, at Hanwha Techwin, used the Mozilla Firefox component without modifying the source code according to the MOZILLA Public license 1.1, we are not obliged to provide the source code of the corresponding component.

- Version 1.1

### 1. Definitions.

1.0.1. "Commercial Use" means distribution or otherwise making the Covered Code available to a third party.

1.1. "Contributor" means each entity that creates or contributes to the creation of Modifications.

1.2. "Covered Code" means the combination of the Original Code, prior Modifications used by a Contributor, and the Modifications made by that particular Contributor.

1.3. "Derived Version" means the Original Code or Modifications or the combination of the Original Code and Modifications, in each case including portions thereof.

1.4. "Electronic Distribution Mechanism" means a mechanism generally accepted in the software development community for the electronic transfer of data.

1.5. "Executable" means Covered Code in any form other than Source Code.

1.6. "Initial Developer" means the individual or entity identified as the Initial Developer in the Source Code notice required by Exhibit A.

1.7. "Larger Work" means a work which combines Covered Code or portions thereof with code not governed by the terms of this License.

1.8. "License" means this document.

1.8.1. "Licensable" means having the right to grant, to the maximum extent possible, whether at the time of the initial grant or subsequently acquired, any and all of the rights conveyed herein.

1.9. "Modifications" means any addition to or deletion from the substance or structure of either the Original Code or any previous Modifications. When Covered Code is released as a series of files, a Modification is:

A. Any addition to or deletion from the contents of a file containing Original Code or previous Modifications.

B. Any new file that contains any part of the Original Code or previous Modifications.

1.10. "Original Code" means Source Code of computer software code which is described in the Source Code notice required by Exhibit A as Original Code, and which, at the time of its release under this License is not already Covered Code governed by this License.

1.10.1. "Patent Claims" means any patent claim(s), now owned or hereafter acquired, including without limitation, method, process, and apparatus claims, in any patent Licensable by grantor.

**1.11.** "Source Code" means the preferred form of the Covered Code for making modifications to it, including all modules it contains, plus any associated interface definition files, scripts used to control compilation and installation of an Executable, or source code differential comparisons against either the Original Code or another well known, available Covered Code of the Contributor's choice. The Source Code can be in a compressed or archival form, provided the appropriate decompression or de-archiving software is widely available for no charge.

**1.12.** "You" (or "Your") means an individual or a legal entity exercising rights under, and complying with all of the terms of, this License or a future version of this License issued under Section 6.1. For legal entities, "You" includes any entity which controls, is controlled by, or is under common control with You. For purposes of this definition, "control" means (a) the power, direct or indirect, to cause the direction or management of such entity, whether by contract or otherwise, or (b) ownership of more than fifty percent (50%) of the outstanding shares or beneficial ownership of such entity.

## 2. Source Code License.

**2.1.** The Initial Developer Grant. The Initial Developer hereby grants You a world-wide, royalty-free, non-exclusive license, subject to third party intellectual property claims:

- (a) under intellectual property rights (other than patent or trademark) licensable by Initial Developer to use, reproduce, modify, display, perform, sublicense and distribute the Original Code (or portions thereof) with or without Modifications, and/or as part of a Larger Work; and
- (b) under Patents Claims infringed by the making, using or selling of Original Code, to make, have made, use, practice, sell, and offer for sale, and/or otherwise dispose of the Original Code (or portions thereof).
- (c) the licenses granted in this Section 2.1(a) and (b) are effective on the date Initial Developer first distributes Original Code under the terms of this License.
- (d) Notwithstanding Section 2.1(b) above, no patent license is granted: 1) for that code that You delete from the Original Code; 2) separate from the Original Code; or 3) for infringements caused by: i) the modification of the Original Code or ii) the combination of the Original Code with other software or devices.

**2.2.** Contributor Grant. Subject to third party intellectual property claims, each Contributor hereby grants You a world-wide, royalty-free, non-exclusive license

- (a) under intellectual property rights (other than patent or trademark) licensable by Contributor, to use, reproduce, modify, display, perform, sublicense and distribute the Modifications created by such Contributor (or portions thereof) either on an unmodified basis, with other Modifications, as Covered Code and/or as part of a Larger Work; and
- (b) under Patent Claims infringed by the making, using, or selling of Modifications made by that Contributor either alone and/or in combination with its Contributor Version (or portions of such combination), to make, use, sell, offer for sale, have made, and/or otherwise dispose of: 1) Modifications made by that Contributor (or portions thereof); and 2) the combination of Modifications made by that Contributor with its Contributor Version (or portions of such combination).
- (c) the licenses granted in Sections 2.2(a) and 2.2(b) are effective on the date Contributor first makes Commercial Use of the Covered Code.
- (d) Notwithstanding Section 2.2(b) above, no patent license is granted: 1) for any code that Contributor has deleted from the Contributor Version; 2) separate from the Contributor Version; 3) for infringements caused by: i) third party modifications of Contributor Version or ii) the combination of Modifications made by that Contributor with other software (except as part of the Contributor Version) or other devices; or 4) under Patent Claims infringed by Covered Code in the absence of Modifications made by that Contributor.

## 3. Distribution Obligations.

**3.1.** Application of License. The Modifications which you create or to which you contribute are governed by the terms of this License, including without limitation Section 2.2. The Source Code version of Covered Code may be distributed only under the terms of this License or a future version of this License released under Section 6.1, and You must include a copy of this License with every copy of the Source Code you distribute. You may not offer or impose any terms on any Source Code version that alters or restricts the applicable version of this License or the recipients' rights hereunder. However, You may include an additional document offering the additional rights described in Section 3.5.

**3.2.** Availability of Source Code. Any Modification which You create or to which You contribute must be made available in Source Code form under the terms of this License either on the same media as an Executable version or via an accepted Electronic Distribution Mechanism to anyone to whom you made an Executable version available; and if made available via Electronic Distribution Mechanism, must remain available for at least twelve (12) months after the date it initially became available, or at least six (6) months after a subsequent version of that particular Modification has been made available to such recipients. You are responsible for ensuring that the Source Code version remains available even if the Electronic Distribution Mechanism is maintained by a third party.

**3.3.** Description of Modifications. You must cause all Covered Code to which You contribute to contain a file documenting the changes You made to create that Covered Code and the date of any change. You must include a prominent statement that the Modification is derived, directly or indirectly, from Original Code provided by the Initial Developer and including the name of the Initial Developer in (a) the Source Code, and (b) in any notice in an Executable version or related documentation in which You describe the origin or ownership of the Covered Code.

## 3.4. Intellectual Property Matters

- (a) Third Party Claims. If Contributor has knowledge that a license under a third party's intellectual property rights is required to exercise the rights granted by such Contributor under Sections 2.1 or 2.2, Contributor must include a text file with the Source Code distribution titled "LEGAL" which describes the claim and the party making the claim in sufficient detail that a recipient will know whom to contact. If Contributor obtains such knowledge after the Modification is made available as described in Section 3.2, Contributor shall promptly modify the LEGAL file in all copies Contributor makes available thereafter and shall take other steps (such as notifying appropriate mailing lists or newsgroups) reasonably calculated to inform those who received the Covered Code that new knowledge has been obtained.
- (b) Contributor APIs. If Contributor's Modifications include an application programming interface and Contributor has knowledge of patent licenses which are reasonably necessary to implement that API, Contributor must also include this information in the LEGAL file.
- (c) Representations.

Contributor represents that, except as disclosed pursuant to Section 3.4(a) above, Contributor believes that Contributor's Modifications are Contributor's original creation(s) and/or Contributor has sufficient rights to grant the rights conveyed by this License.

**3.5.** Required Notices. You must duplicate the notice in Exhibit A in each file of the Source Code. If it is not possible to put such notice in a particular Source Code file due to its structure, then You must include such notice in a location (such as a relevant directory) where a user would be likely to look for such a notice. If You created one or more Modifications(s) You may add your name as a Contributor to the notice described in Exhibit A. You must also duplicate this License in any documentation for the Source Code where You describe recipients' rights or ownership rights relating to Covered Code. You may choose to offer, and to charge a fee for, warranty, support, indemnity or liability obligations to one or more recipients of Covered Code. However, You may do so only on Your own behalf, and not on behalf of the Initial Developer or any Contributor. You must make it absolutely clear that any such warranty, support, indemnity or liability obligation is offered by You alone, and You hereby agree to indemnify the Initial Developer and every Contributor for any liability incurred by the Initial Developer or such Contributor as a result of warranty, support, indemnity or liability terms You offer.

**3.6.** Distribution of Executable Versions. You may distribute Covered Code in Executable form only if the requirements of Section 3.1-3.5 have been met for that Covered Code, and if You include a notice stating that the Source Code version of the Covered Code is available under the terms of this License, including a description of how and where You have fulfilled the obligations of Section 3.2. The notice must be conspicuously included in any notice in an Executable version, related documentation or collateral in which You describe recipients' rights relating to the Covered Code. You may distribute the Executable version of Covered Code or ownership rights under a license of Your choice, which may contain terms different from this License, provided that You are in compliance with the terms of this License and that the license

for the Executable version does not attempt to limit or alter the recipient's rights in the Source Code version from the rights set forth in this License. If You distribute the Executable version under a different license You must make it absolutely clear that any terms which differ from this License are offered by You alone, not by the Initial Developer or any Contributor. You hereby agree to indemnify the Initial Developer and every Contributor for any liability incurred by the Initial Developer or such Contributor as a result of any such terms You offer.

**3.7.** Larger Works. You may create a Larger Work by combining Covered Code with other code not governed by the terms of this License and distribute the Larger Work as a single product. In such a case, You must make sure the requirements of this License are fulfilled for the Covered Code.

## 4. Inability to Comply Due to Statute or Regulation.

If it is impossible for You to comply with any of the terms of this License with respect to some or all of the Covered Code due to statute, judicial order, or regulation then You must: (a) comply with the terms of this License to the maximum extent possible; and (b) describe the limitations and the code they affect. Such description must be included in the LEGAL file described in Section 3.4 and must be included with all distributions of the Source Code. Except to the extent prohibited by statute or regulation, such description must be sufficiently detailed for a recipient of ordinary skill to be able to understand it.

## 5. Application of this License.

This License applies to code to which the Initial Developer has attached the notice in Exhibit A and to related Covered Code.

## 6. Versions of the License.

**6.1.** New Versions. Netscape Communications Corporation ("Netscape") may publish revised and/or new versions of the License from time to time. Each version will be given a distinguishing version number.

**6.2.** Effect of New Versions. Once Covered Code has been published under a particular version of the License, You may always continue to use it under the terms of that version. You may also choose to use such Covered Code under the terms of any subsequent version of the License published by Netscape. No one other than Netscape has the right to modify the terms applicable to Covered Code created under this License.

**6.3.** Derivative Works. If You create or use a modified version of this License (which you may only do in order to apply it to code which is not already Covered Code governed by this License), You must (a) rename your license so that the phrases "Mozilla", "MOZILLAPL", "MOZPL", "Netscape", "MPL", "NPL" or any confusingly similar phrase do not appear in your license (except to note that your license differs from this License) and (b) otherwise make it clear that Your version of the license contains terms which differ from the Mozilla Public License and Netscape Public License. (Filing in the name of the Initial Developer, Original Code or Contributor in the notices described in Exhibit A shall not of themselves be deemed to be modifications of this License.)

## 7. DISCLAIMER OF WARRANTY.

COVERED CODE IS PROVIDED UNDER THIS LICENSE ON AN "AS IS" BASIS, WITHOUT WARRANTY OF ANY KIND, EITHER EXPRESSED OR IMPLIED, INCLUDING, WITHOUT LIMITATION, WARRANTIES THAT THE COVERED CODE IS FREE OF DEFECTS, MERCHANTABILITY, FIT FOR A PARTICULAR PURPOSE OR NON-INFRINGEMENT. THE ENTIRE RISK AS TO THE QUALITY AND PERFORMANCE OF THE COVERED CODE IS WITH YOU. SHOULD ANY COVERED CODE PROVE DEFECTIVE IN ANY RESPECT, YOU (NOT THE INITIAL DEVELOPER OR ANY OTHER CONTRIBUTOR) ASSUME THE COST OF ANY NECESSARY SERVICING, REPAIR OR CORRECTION. THIS DISCLAIMER OF WARRANTY CONSTITUTES AN ESSENTIAL PART OF THIS LICENSE. NO USE OF ANY COVERED CODE IS AUTHORIZED HEREUNDER EXCEPT UNDER THIS DISCLAIMER.

## 8. TERMINATION.

**8.1.** This License and the rights granted hereunder will terminate automatically if You fail to comply with terms herein and fail to cure such breach within 30 days of becoming aware of the breach. All sublicenses to the Covered Code which are properly granted shall survive any termination of this License. Provisions which, by their nature, must remain in effect beyond the termination of this License shall survive.

**8.2.** If You initiate litigation by asserting a patent infringement claim (excluding declaratory judgment actions) against Initial Developer or a Contributor (the Initial Developer or Contributor against whom You file such action is referred to as "Participant") alleging that:

- (a) such Participant's Contributor Version directly or indirectly infringes any patent, then any and all rights granted by such Participant to You under Sections 2.1 and/or 2.2 of this License shall, upon 60 days notice from Participant terminate prospectively, unless if within 60 days after receipt of notice You either: (i) agree in writing to pay Participant a mutually agreeable reasonable royalty for Your past and future use of Modifications made by such Participant, or (ii) withdraw Your litigation claim with respect to the Contributor Version against such Participant. If within 60 days of notice, a reasonable royalty and payment arrangement are not mutually agreed upon in writing by the parties or the litigation claim is not withdrawn, the rights granted by Participant to You under Sections 2.1 and/or 2.2 automatically terminate at the expiration of the 60 day notice period specified above.

- (b) any software, hardware, or device, other than such Participant's Contributor Version, directly or indirectly infringes any patent, then any rights granted to You by such Participant under Sections 2.1(b) and 2.2(b) are revoked effective as of the date You first made, used, sold, distributed, or had made, Modifications made by that Participant.

**8.3.** If You assert a patent infringement claim against Participant alleging that such Participant's Contributor Version directly or indirectly infringes any patent where such claim is resolved (such as by license or settlement) prior to the initiation of patent infringement litigation, then the reasonable value of the licenses granted by such Participant under Sections 2.1 or 2.2 shall be taken into account in determining the amount or value of any payment or license.

**8.4.** In the event of termination under Sections 8.1 or 8.2 above, all end user license agreements (excluding distributors and resellers) which have been validly granted by You or any distributor hereunder prior to termination shall survive termination.

## 9. LIMITATION OF LIABILITY.

UNDER NO CIRCUMSTANCES AND UNDER NO LEGAL THEORY, WHETHER TORT (INCLUDING NEGLIGENCE), CONTRACT, OR OTHERWISE, SHALL YOU, THE INITIAL DEVELOPER, ANY OTHER CONTRIBUTOR, OR ANY DISTRIBUTOR OF COVERED CODE, OR ANY SUPPLIER OF ANY OF SUCH PARTIES, BE LIABLE TO ANY PERSON FOR ANY INDIRECT, SPECIAL, INCIDENTAL, OR CONSEQUENTIAL DAMAGES OF ANY CHARACTER INCLUDING, WITHOUT LIMITATION, DAMAGES FOR LOSS OF GOODWILL, WORK STOPPAGE, COMPUTER FAILURE OR MALFUNCTION, OR ANY AND ALL OTHER COMMERCIAL DAMAGES OR LOSSES, EVEN IF SUCH PARTY SHALL HAVE BEEN INFORMED OF THE POSSIBILITY OF SUCH DAMAGES. THIS LIMITATION OF LIABILITY SHALL NOT APPLY TO LIABILITY FOR DEATH OR PERSONAL INJURY RESULTING FROM SUCH PARTY'S NEGLIGENCE TO THE EXTENT APPLICABLE LAW PROHIBITS SUCH LIMITATION. SOME JURISDICTIONS DO NOT ALLOW THE EXCLUSION OR LIMITATION OF INCIDENTAL OR CONSEQUENTIAL DAMAGES. SO THIS EXCLUSION AND LIMITATION MAY NOT APPLY TO YOU. 10. U.S. GOVERNMENT END USERS.

The Covered Code is a "commercial item," as that term is defined in 48 C.F.R. 2.101 (Oct. 1995), consisting of "commercial computer software" and "commercial computer software documentation," as such terms are used in 48 C.F.R. 12.212 (Sept. 1995). Consistent with 48 C.F.R. 12.212 and 48 C.F.R. 227.7202-1 through 227.7202-4 (June 1995), all U.S. Government End Users acquire Covered Code with only those rights set forth herein.

## 11. MISCELLANEOUS.

This License represents the complete agreement concerning subject matter hereof. If any provision of this License is held to be unenforceable, such provision shall be reformed only to the extent necessary to make it enforceable. This License shall be governed by California law provisions (except to the extent applicable law, if any, provides otherwise), excluding its conflict-of-law provisions. With respect to disputes in which at least one party is a citizen of, or an entity chartered or registered to do business in the United States of America, any litigation relating to this License shall be subject to the jurisdiction of the Federal Courts of the Northern District of California, with venue lying in Santa Clara County, California, with the losing party responsible for costs, including without limitation, court costs and reasonable attorneys' fees and expenses. The application of the United Nations Convention on Contracts for the International Sale of Goods is expressly excluded. Any law or regulation which

provides that the language of a contract shall be construed against the drafter shall not apply to this License.

## 12. RESPONSIBILITY FOR CLAIMS.

As between Initial Developer and the Contributors, each party is responsible for claims and damages arising, directly or indirectly, out of its utilization of rights under this License and You agree to work with Initial Developer and Contributors to distribute such responsibility on an equitable basis. Nothing herein is intended or shall be deemed to constitute any admission of liability.

## 13. MULTIPLE-LICENSED CODE.

Initial Developer may designate portions of the Covered Code as Multiple-Licensed. Multiple-Licensed means that the Initial Developer permits you to utilize portions of the Covered Code under Your choice of the MPL or the alternative licenses, if any, specified by the Initial Developer in the file described in Exhibit A.

### EXHIBIT A -Mozilla Public License.

The contents of this file are subject to the Mozilla Public License Version 1.1 (the "License"); you may not use this file except in compliance with the License. You may obtain a copy of the License at <http://www.mozilla.org/MPL/Software> distributed under the License is distributed on an "AS IS" basis, WITHOUT WARRANTY OF ANY KIND, either express or implied. See the License for the specific language governing rights and limitations under the License.

The Original Code is \_\_\_\_\_.

The Initial Developer of the Original Code is \_\_\_\_\_; Portions created by \_\_\_\_\_ are Copyright (C) \_\_\_\_\_, All Rights Reserved.

Contributor(s): \_\_\_\_\_.

Alternatively, the contents of this file may be used under the terms of the \_\_\_\_\_ license (the [\_\_\_\_\_] License), in which case the provisions of [\_\_\_\_\_] License are applicable instead of those above. If you wish to allow use of your version of this file only under the terms of the [\_\_\_\_\_] License and not to allow others to use your version of this file under the MPL, indicate your decision by deleting the provisions above and replace them with the notice and other provisions required by the [\_\_\_\_\_] License. If you do not delete the provisions above, a recipient may use your version of this file under either the MPL or the [\_\_\_\_\_] License.\*

[NOTE: The text of this Exhibit A may differ slightly from the text of the notices in the Source Code files of the Original Code. You should use the text of this Exhibit A rather than the text found in the Original Code Source Code for Your Modifications

## The Independent JPEG Group's JPEG Software

The software included in this product contains copyrighted software that is licensed under the JPEG license.

- JPEG license
- Code project . Generating Outline OpenGL, Libjpeg

This distribution contains the sixth public release of the Independent JPEG Group's free JPEG software. You are welcome to redistribute this software and to use it for any purpose, subject to the conditions under LEGAL ISSUES, below.

Serious users of this software (particularly those incorporating it into larger programs) should contact IJG at [jpeg-info@uunet.uu.net](mailto:jpeg-info@uunet.uu.net) to be added to our electronic mailing list. Mailing list members are notified of updates and have a chance to participate in technical discussions, etc.

This software is the work of Tom Lane, Philip Gladstone, Jim Boucher, Lee Crocker, Julian Minguijon, Luis Ortiz, George Phillips, Davide Rossi, Guido Vollbeding, Ge' Weijers, and other members of the Independent JPEG Group.

IJG is not affiliated with the official ISO JPEG standards committee.

## LEGAL ISSUES

=====

### In plain English:

1. We don't promise that this software works. (But if you find any bugs, please let us know!)
2. You can use this software for whatever you want. You don't have to pay us.
3. You may not pretend that you wrote this software. If you use it in a program, you must acknowledge somewhere in your documentation that you've used the IJG code.

### In legalese:

The authors make NO WARRANTY or representation, either express or implied, with respect to this software, its quality, accuracy, merchantability, or fitness for a particular purpose. This software is provided "AS IS", and you, its user, assume the entire risk as to its quality and accuracy.

This software is copyright (C) 1991-1998, Thomas G. Lane. All Rights Reserved except as specified below.

Permission is hereby granted to use, copy, modify, and distribute this software (or portions thereof) for any purpose, without fee, subject to these conditions:

(1) If any part of the source code for this software is distributed, then this README file must be included, with this copyright and no-warranty notice unaltered; and any additions, deletions, or changes to the original files must be clearly indicated in accompanying documentation.

(2) If only executable code is distributed, then the accompanying documentation must state that "this software is based in part on the work of the Independent JPEG Group".

(3) Permission for use of this software is granted only if the user accepts full responsibility for any undesirable consequences; the authors accept NO LIABILITY for damages of any kind.

These conditions apply to any software derived from or based on the IJG code, not just to the unmodified library. If you use our work, you ought to acknowledge us.

Permission is NOT granted for the use of any IJG author's name or company name in advertising or publicity relating to this software or products derived from it. This software may be referred to only as "the Independent JPEG Group's software".

We specifically permit and encourage the use of this software as the basis of commercial products, provided that all warranty or liability claims are assumed by the product vendor.

ansi2knr.c is included in this distribution by permission of L. Peter Deutsch, sole proprietor of its copyright holder, Aladdin Enterprises of Menlo Park, CA.

ansi2knr.c is NOT covered by the above copyright and conditions, but instead by the usual distribution terms of the Free Software Foundation; principally, that you must include source code if you redistribute it. (See the file ansi2knr.c for full details.) However, since ansi2knr.c is not needed as part of any program generated from the IJG code, this does not limit you more than the foregoing paragraphs do.

The Unix configuration script "configure" was produced with GNU Autoconf. It is copyright by the Free Software Foundation but is freely distributable. The same holds for its supporting scripts (config.guess, config.sub, ltconfig, ltmain.sh). Another support script, install-sh, is copyright by M.I.T. but is also freely distributable.

It appears that the arithmetic coding option of the JPEG spec is covered by patents owned by IBM, AT&T, and Mitsubishi. Hence arithmetic coding cannot legally be used without obtaining one or more licenses. For this reason, support for arithmetic coding has been removed from the free JPEG software. (Since arithmetic coding provides only a marginal gain over the unpatedented Huffman mode, it is unlikely that very many implementations will support it.) So far as we are aware, there are no patent restrictions on the remaining code.

The IJG distribution formerly included code to read and write GIF files. To avoid entanglement with the Unisys LZW patent, GIF reading support has been removed altogether, and the GIF writer has been simplified to produce "uncompressed GIFs". This technique does not use the LZW algorithm; the resulting GIF files are larger than usual, but are readable by all standard GIF decoders.

We are required to state that

\*The Graphics Interchange Format(c) is the Copyright property of CompuServe Incorporated. GIF(sm) is a Service Mark property of CompuServe Incorporated.\*

## T-Kernel License

---

- This Product uses the Source Code of T-Kernel under T-License granted by the T-Engine Forum([www.t-engine.org](http://www.t-engine.org))

---

### T-License [License Agreement for Source Code of T-Kernel]

established by T-Engine Forum  
on January 23, 2004  
revised on June 17, 2004  
revised on December 21, 2006  
revised on March 24, 2009

#### Article 1. Scope of License Agreement

1. This License Agreement sets forth copyrights and the terms and conditions of use applicable to the source code of T-Kernel distributed by T-Engine Forum and any derivative work created therefrom.

#### Article 2. Definition

1. "T-Kernel" means a real-time operating system controlled and distributed by T-Engine Forum on behalf of the copyright holder thereof.
2. "Source Code" means a source program, including related comments and documentations, for the T-Kernel and the Ported Source Code defined in Article 2.8 which is registered with T-Engine Forum.
3. "Hardware-dependent Part" means the part of the Source Code which depends on hardware and needs to be changed when the Source Code is ported and operated on the target hardware, and is designated and separated as such part.
4. "Compiler-dependent Part" means the part of the Source Code which depends on compiler and needs to be changed when the Source Code is ported and operated on the target hardware, and is designated and separated as such part.
5. "Header File" means the part of the Source Code which contains definitions necessary to develop application programs.
6. "T-Engine Hardware" means the hardware which is manufactured in accordance with the T-Engine Hardware specifications or the  $\mu$ T-Engine Hardware specifications issued by T-Engine Forum, and registered with T-Engine Forum.
7. "Similar Hardware to T-Engine Hardware" means any hardware (including software which emulates hardware) other than that defined in Article 2.6 above, on which the T-Kernel can be operated.
8. "Ported Source Code" means a source program produced from the Source Code by modifying only its Hardwaredependent Part and/or Compiler-dependent Part to enable it to be operated on the T-Engine Hardware or the Similar Hardware to T-Engine Hardware. The Ported Source Code which is registered with T-Engine Forum shall be included in the Source Code.
9. "Modified Source Code" means a source program modified from the Source Code for the purpose of improving its performance, increasing or decreasing its function, and the like. The Ported Source Code shall not be included in the Modified Source Code.
10. "Binary Code" means an executable code form which is created by compiling programs, which include all or part of the Source Code or the Modified Source Code.
11. "Derivative Work" means the Modified Source Code or the Binary Code.
12. "Embedded Product" means any product which operates with executable code form of the Source Code, the Modified Source Code or the Binary Code loaded on its hardware.
13. "End User" means a consumer who uses the Embedded Product.
14. "System Developer" means any person who develops the Embedded Product by itself or has a third party develop the same, and provides, whether with or without payment, the End User with the Embedded Product.
15. "Distributor of Modification" means any person who produces the Modified Source Code and, whether with or without payment, distributes the same to any third party.

**16.** "Patch for Modification" means a difference, program, system, or the like in order to create the Modified Source Code from the Source Code or the Binary Code thereof.

**17.** "Vicarious Execution of Patch Processing" means vicarious execution service to create the Modified Source Code applying the Patch for Modification to the Source Code or the Binary Code thereof.

**18.** "Source Code User" means a person who uses the Source Code.

**19.** "Distribution" means any of the following acts:

1. to transmit a work to a large number of specific persons through the Internet communication, broadcasting, and the like;
2. to transmit a work to the general public through the Internet communication, broadcasting, and the like automatically in response to a request from the public; and
3. to distribute a copy of a work to the general public or a large number of specific persons.

#### **Article 3. Copyright**

1. The copyrights of the Source Code shall be owned by Ken Sakamura.

#### **Article 4. License of Source Code**

1. As provided for in this Article, T-Engine Forum shall provide, and grant a license to use, the Source Code free of charge to any person who has taken the necessary procedure for registration as prescribed by T-Engine Forum and agreed to the T-License.

2. The Source Code shall be distributed exclusively by T-Engine Forum. Any person who obtains the Source Code under Article 4.1 above shall not make any re-Distribution of the Source Code.

3. In accordance with the license granted under Article 4.1 above, the Source Code User may perform the following acts:

1. to copy and/or modify the Source Code provided by T-Engine Forum hereunder for its own research, development and the like.
  2. to run the Source Code provided by T-Engine Forum hereunder for its own research, development and the like.
  3. to run the Source Code modified in accordance with the provision of Article 4.3 (1) above for its own research, development and the like.
  4. to distribute the Binary Code created from the Source Code provided by T-Engine Forum hereunder or from the Source Code modified in accordance with the provision of Article 4.3 (1) above.
4. In accordance with the license granted under Article 4.1 above, the System Developer may perform the following acts:

1. to perform any and all acts set forth in the Article 4.3 above.
2. to develop and manufacture the Embedded Product containing the Binary Code, and, whether with or without payment, provide the End User with the same and make the Binary Code available to the End User on the Embedded Product.

5. The Source Code User and the System Developer shall be obligated to give a notice that the Source Code is used, in such a way as separately specified by T-Engine Forum, when they use the Source Code or the Binary Code, or make the Binary Code available for the End User on the Embedded Product.

#### **Article 5. Distribution of Modified Source Code**

1. Any of A- members of T-Engine Forum may become the Distributor of Modification by obtaining the approval of T-Engine Forum through the registration procedure as prescribed by the Forum provided that only the department of the A- member which has taken the registration procedure may distribute the Modified Source Code in such a way as provided for in this Article as long as it holds the Amembership.

2. The Distributor of Modification may create the Modified Source Code based on the Source Code provided by T-Engine Forum and the Patch for Modification to be applied to create such Modified Source Code from the Source Code.

3. The Distributor of Modification shall, prior to the distribution, inform T-Engine Forum of and register a name and description of the Modified Source Code in such a way as specified by T-Engine Forum.

4. The Distributor of Modification shall determine the name of the Modified Source Code subject to the rules separately established by T-Engine Forum and publish an appropriate notice as required by the rules on the Patch for Modification and the Modified Source Code.

5. The Distributor of Modification may distribute the Modified Source Code to a third party, whether with or without payment, provided that the Distributor of Modification shall take the necessary measures to prohibit the third party from making the re-Distribution of the Modified Source Code.

6. Developer with the Patch for Modification. Provided, however, that the Distributor of Modification shall be obligated to confirm that the System Developer is the Source Code User duly licensed under Article 4.1.

7. The Distributor of Modification may perform the Vicarious Execution of Patch Processing for the System Developer.

8. The System Developer shall not distribute the Modified Source Code in further modified form to any third party as a stand-alone software product.

9. The System Developer may, under the same obligation as imposed in Article 4.5, make the Embedded Product available for the End User through use of the Patch for Modification distributed by the Distributor of Modification or the Derivative Works obtained through the Vicarious Execution of Patch Processing.

#### **Article 6. Distribution and Registration of the Ported Source Code**

1. The Source Code User and the System Developer may, whether with or without charge, distribute to any third party only the following parts of the Ported

Source Code on the T-Engine Hardware or the Similar Hardware to T-Engine Hardware:

1. The Hardware-dependent Part and/or Compiler-dependent Part; provided that the Source Code User and the System Developer shall inform T-Engine Forum of, and T-Engine Forum may publish, a method for distributing said Part(s) to third parties.

2. The Header File; provided that the Header File shall be distributed together with the Binary Code of the Ported Source Code.

2. Any member of T-Engine Forum may request T-Engine Forum to register and distribute, as an original source code for T-Kernel, the Ported Source Code on the T-Engine Hardware or the Similar Hardware to T-Engine Hardware.

3. Any member of T-Engine Forum who requests the distribution mentioned in the preceding paragraph shall accede to the following conditions:

1. The member shall confirm that the object hardware is the T-Engine Hardware or the Similar Hardware to T-Engine Hardware.
2. The member shall provide T-Engine Forum with a complete set of operational environment for the object hardware and T-Kernel free of charge when requesting the distribution.
3. The member shall submit test results of the Ported Source Code to T-Engine Forum when requesting the distribution.

4. In the event that T-Engine Forum accepts the request mentioned in Article 6.2, T-Engine Forum shall register and distribute the Ported Source Code as the Source Code for T-Kernel. Provided, however, that the Ported Source Code may be treated in the same way as the Modified Source Code until the time of registration hereunder.

5. The provision set forth in Article 3 shall apply to the Ported Source Code registered in accordance with this Article.

#### **Article 7. Use for Other Purpose**

1. Any use of the Source Code, the Modified Source Code or the Ported Source Code other than those stipulated in Articles 4, 5 and 6 shall be subject to the prior approval of T-Engine Forum.

#### **Article 8. Limited Warranty**

1. T-Engine Forum and the copyright holder of the Source Code warrant that the Source Code does not infringe third party's copyrights. Provided, however, that T-Engine Forum and the copyright holder of the Source Code make no warranty as to the Hardware-dependent Part and/or Compiler-dependent Part set forth in Article 6.2 in the Ported Source Code by any third party.

2. Neither T-Engine Forum nor the copyright holder of the Source Code warrants that the Source Code will fit for any particular purpose of the Source Code User.

3. Neither T-Engine Forum nor the copyright holder of the Source Code warrants that the Source Code does not infringe any third party's industrial property rights. In no event shall T-Engine Forum and the copyright holder of the Source Code be liable for any dispute which may arise between the Source Code User and a third party in connection with the third party's industrial property rights.

#### **Article 9. Indemnity**

1. Neither T-Engine Forum nor the copyright holder of the Source Code shall be liable for any damages (including, but not limited to, damages resulting from loss of profit, business interruption, loss of business information or any other pecuniary damage) arising out of use or impossibility of use of the Source Code, even if T-Engine Forum and the copyright holder have been informed of the possibility of such damages.

#### **Article 10. Breach of Agreement**

1. In case that T-Engine Forum considers that this License Agreement is breached or that the popularization of T-Kernel is obstructed, T-Engine Forum shall take measures to correct such breach or such obstruction, take measures on the ground of copyright infringement, or take any other necessary measures against the breaching person or the obstructing person, regardless of whether or not the said person is a member of T-Engine Forum.

2. In case of breach of this License Agreement by a member of T-Engine Forum, T-Engine Forum may take appropriate measures against the member; for example, the member is disqualified from membership, depending on what kind of breach has been committed by it.

3. Any legal dispute which may arise in relation to any breach of this License Agreement shall be subject to the exclusive jurisdiction of the Tokyo District Court.

#### **Article 11. Governing Law and Language**

1. This License Agreement shall be governed by and interpreted under the laws of Japan.

2. This License Agreement is executed in both Japanese text and English text provided that the Japanese text shall govern the interpretation and performance of this License Agreement.

### **Apache License 2.0**

Component	Name License	URL
mDNSResponder_bonjour	Apache License 2.0	<a href="http://www.apache.org/licenses/LICENSE-2.0">http://www.apache.org/licenses/LICENSE-2.0</a>

#### **TERMS AND CONDITIONS FOR USE, REPRODUCTION, AND DISTRIBUTION**

1. Definitions.

"License" shall mean the terms and conditions for use, reproduction, and distribution as defined by Sections 1 through 9 of this document.

"Licensor" shall mean the copyright owner or entity authorized by the copyright owner that is granting the License.

"Legal Entity" shall mean the union of the acting entity and all other entities that control, are controlled by, or are under common control with that entity. For the purposes of this definition, "control" means (i) the power, direct or indirect, to cause the direction or management of such entity, whether by contract or otherwise, or (ii) ownership of fifty percent (50%) or more of the outstanding shares, or (iii) beneficial ownership of such entity.

"You" (or "Your") shall mean an individual or Legal Entity exercising permissions granted by this License. "Source" form shall mean the preferred form for making modifications, including but not limited to software source code, documentation source, and configuration files.

"Object" form shall mean any form resulting from mechanical transformation or translation of a Source form, including but not limited to compiled object code, generated documentation, and conversions to other media types.

"Work" shall mean the work of authorship, whether in Source or Object form, made available under the License, as indicated by a copyright notice that is included in or attached to the work (an example is provided in the Appendix below).

"Derivative Works" shall mean any work, whether in Source or Object form, that is based on (or derived from) the Work and for which the editorial revisions, annotations, elaborations, or other modifications represent, as a whole, an original work of authorship. For the purposes of this License, Derivative Works shall not include works that remain separable from, or merely link (or bind by name) to the interfaces of, the Work and Derivative Works thereof.

"Contribution" shall mean any work of authorship, including the original version of the Work and any modifications or additions to that Work or Derivative Works thereof, that is intentionally submitted to Licensor for inclusion in the Work by the copyright owner or by an individual or Legal Entity authorized to submit on behalf of the copyright owner. For the purposes of this definition, "submitted" means any form of electronic, verbal, or written communication sent to the Licensor or its representatives, including but not limited to communication on electronic mailing lists, source code control systems, and issue tracking systems that are managed by, or on behalf of, the Licensor for the purpose of discussing and improving the Work, but excluding communication that is conspicuously marked or otherwise designated in writing by the copyright owner as "Not a Contribution." "Contributor" shall mean Licensor and any individual or Legal Entity on behalf of whom a Contribution has been received by Licensor and subsequently incorporated within the Work.

- Grant of Copyright License. Subject to the terms and conditions of this License, each Contributor hereby grants to You a perpetual, worldwide, non-exclusive, no-charge, royalty-free, irrevocable copyright license to reproduce, prepare Derivative Works of, publicly display, publicly perform, sublicense, and distribute the Work and such Derivative Works in Source or Object form.
- Grant of Patent License. Subject to the terms and conditions of this License, each Contributor hereby grants to You a perpetual, worldwide, non-exclusive, no-charge, royalty-free, irrevocable (except as stated in this section) patent license to make, have made, use, offer to sell, sell, import, and otherwise transfer the Work, where such license applies only to those patent claims licensable by such Contributor that are necessarily infringed by their Contribution(s) alone or by combination of their Contribution(s) with the Work to which such Contribution(s) was submitted. If You institute patent litigation against any entity (including a crossclaim or counterclaim in a lawsuit) alleging that the Work or a Contribution incorporated within the Work constitutes direct or contributory patent infringement, then any patent licenses granted to You under this License for that Work shall terminate as of the date such litigation is filed.

- Redistribution. You may reproduce and distribute copies of the Work or Derivative Works thereof in any medium, with or without modifications, and in Source or Object form, provided that You meet the following conditions:

- You must give any other recipients of the Work or Derivative Works a copy of this License; and
- You must cause any modified files to carry prominent notices stating that You changed the files; and
- You must retain, in the Source form of any Derivative Works that You distribute, all copyright, patent, trademark, and attribution notices from the Source form of the Work, excluding those notices that do not pertain to any part of the Derivative Works; and
- If the Work includes a "NOTICE" text file as part of its distribution, then any Derivative Works that You distribute must include a readable copy of the attribution notices contained within such NOTICE file, excluding those notices that do not pertain to any part of the Derivative Works, in at least one of the following places: within a NOTICE text file distributed as part of the Derivative Works; within the Source form or documentation, if provided along with the Derivative Works; or, within a display generated by the Derivative Works, if and wherever such third-party notices normally appear. The contents of the NOTICE file are for informational purposes only and do not modify the License. You may add Your own attribution notices within Derivative Works that You distribute, alongside or as an addendum to the NOTICE text from the Work, provided that such additional attribution notices cannot be construed as modifying the License.

You may add Your own copyright statement to Your modifications and may provide additional or different license terms and conditions for use, reproduction, or distribution of Your modifications, or for any such Derivative Works as a whole, provided Your use, reproduction, and distribution of the Work otherwise complies with the conditions stated in this License.

- Submission of Contributions. Unless You explicitly state otherwise, any Contribution intentionally submitted for inclusion in the Work by You to the Licensor shall be under the terms and conditions of this License, without any additional terms or conditions. Notwithstanding the above, nothing herein shall supersede or modify the terms of any separate license agreement you may have executed with Licensor regarding such Contributions.

- Trademarks. This License does not grant permission to use the trade names, trademarks, service marks, or product names of the Licensor, except as required for reasonable and customary use in describing the origin of the Work and reproducing the content of the NOTICE file.

- Disclaimer of Warranty. Unless required by applicable law or agreed to in writing, Licensor provides the Work (and eachContributor provides its Contributions) on an "AS IS" BASIS, WITHOUT WARRANTIES OR CONDITIONS OF ANY KIND, either express or implied, including, without limitation, any warranties or conditions of TITLE, NON-INFRINGEMENT, MERCHANTABILITY, or FITNESS FOR A PARTICULAR PURPOSE. You are solely responsible for determining the appropriateness of using or redistributing the Work and assume any risks associated with Your exercise of permissions under this License.

- Limitation of Liability. In no event and under no legal theory, whether in tort (including negligence), contract, or otherwise, unless required by applicable law (such as deliberate and grossly negligent acts) or agreed to in writing, shall any Contributor be liable to You for damages, including any direct, indirect, special, incidental, or consequential damages of any character arising as a result of this License or out of the use or inability to use the Work (including but not limited to damages for loss of goodwill, work stoppage, computer failure or malfunction, or any and all other commercial damages or losses), even if such Contributor has been advised of the possibility of such damages.

- Accepting Warranty or Additional Liability. While redistributing the Work or Derivative Works thereof, You may choose to offer, and charge a fee for, acceptance of support, warranty, indemnity, or other liability obligations and/or rights consistent with this License. However, in accepting such obligations, You may act only on Your own behalf and on Your sole responsibility, not on behalf of any other Contributor, and only if You agree to indemnify, defend, and hold each Contributor harmless for any liability incurred by, or claims asserted against, such Contributor by reason of your accepting any such warranty or additional liability.

## END OF TERMS AND CONDITIONS

APPENDIX: How to apply the Apache License to your work.

To apply the Apache License to your work, attach the following boilerplate notice, with the fields enclosed by brackets [ ] replaced with your own identifying information. (Don't include the brackets!) The text should be enclosed in the appropriate comment syntax for the file format. We also recommend that a file or class name and description of purpose be included on the same "printed page" as the copyright notice for easier identification within third-party archives.

Copyright [yyyy] [name of copyright owner]

Licensed under the Apache License, Version 2.0 (the "License"); you may not use this file except in compliance with the License. You may obtain a copy of the License at <http://www.apache.org/licenses/LICENSE-2.0>

Unless required by applicable law or agreed to in writing, software distributed under the License is distributed on an "AS IS" BASIS, WITHOUT WARRANTIES OR CONDITIONS OF ANY KIND, either express or implied. See the License for the specific language governing permissions and limitations under the License.

## BZip2 License

This program, "bzip2", the associated library "libbzip2", and all documentation, are copyright (C) 1996-2007 Julian R Seward. All rights reserved.

Component Name	License	URL
bzip2-1.0.6	Bzip2	<a href="http://www.bzip.org/">http://www.bzip.org/</a>

Redistribution and use in source and binary forms, with or without modification, are permitted provided that the following conditions are met:

- Redistributions of source code must retain the above copyright notice, this list of conditions and the following disclaimer.
- The origin of this software must not be misrepresented; you must not claim that you wrote the original software. If you use this software in a product, an acknowledgment in the product documentation would be appreciated but is not required.
- Altered source versions must be plainly marked as such, and must not be misrepresented as being the original software.
- The name of the author may not be used to endorse or promote products derived from this software without specific prior written permission.

THIS SOFTWARE IS PROVIDED BY THE AUTHOR "AS IS" AND ANY EXPRESS OR IMPLIED WARRANTIES, INCLUDING, BUT NOT LIMITED TO, THE IMPLIED WARRANTIES OF MERCHANTABILITY AND FITNESS FOR A PARTICULAR PURPOSE ARE DISCLAIMED. IN NO EVENT SHALL THE AUTHOR BE LIABLE FOR ANY DIRECT, INDIRECT, INCIDENTAL, SPECIAL, EXEMPLARY, OR CONSEQUENTIAL DAMAGES (INCLUDING, BUT NOT LIMITED TO, PROCUREMENT OF SUBSTITUTE GOODS OR SERVICES; LOSS OF USE, DATA, OR PROFITS; OR BUSINESS INTERRUPTION) HOWEVER CAUSED AND ON ANY THEORY OF LIABILITY, WHETHER IN CONTRACT, STRICT LIABILITY, OR TORT (INCLUDING NEGLIGENCE OR OTHERWISE) ARISING IN ANY WAY OUT OF THE USE OF THIS SOFTWARE, EVEN IF ADVISED OF THE POSSIBILITY OF SUCH DAMAGE.

Julian Seward, [jseward@bzip.org](mailto:jseward@bzip.org)

bzip2/libbzip2 version 1.0.5 of 10 December 2007

## University of Illinois / NCSA Open Source License

Copyright (c) 1999-2007, The Board of Trustees of the University of Illinois All Rights Reserved.

Component Name	License
iperf-2.0.5	University of Illinois / NCSA Open Source

iperf performance test

Mark Gates

Ajay Tirumala

Jim Ferguson

Jon Dugan

Feng Qin

Kevin Gibbs

John Estabrook

National Laboratory for Applied Network Research

National Center for Supercomputing Applications

University of Illinois at Urbana-Champaign

<http://www.ncsa.uiuc.edu>

Permission is hereby granted, free of charge, to any person obtaining a copy of this software (iperf) and associated documentation files (the "Software"), to deal in the Software without restriction, including without limitation the rights to use, copy, modify, merge, publish, distribute, sublicense, and/or sell copies of the Software, and to permit persons to whom the Software is furnished to do so, subject to the following conditions:

Redistributions of source code must retain the above copyright notice, this list of conditions and the following disclaimers.

Redistributions in binary form must reproduce the above copyright notice, this list of conditions and the following disclaimers in the documentation and/or other materials provided with the distribution.

Neither the names of the University of Illinois, NCSA, nor the names of its contributors may be used to endorse or promote products derived from this Software without specific prior written permission. THE SOFTWARE IS PROVIDED "AS IS", WITHOUT WARRANTY OF ANY KIND, EXPRESS OR IMPLIED, INCLUDING BUT NOT LIMITED TO THE WARRANTIES OF MERCHANTABILITY, FITNESS FOR A PARTICULAR PURPOSE AND NON-INFRINGEMENT. IN NO EVENT SHALL THE CONTRIBUTORS OR COPYRIGHT HOLDERS BE LIABLE FOR ANY CLAIM, DAMAGES OR OTHER LIABILITY, WHETHER IN AN ACTION OF CONTRACT, TORT OR OTHERWISE, ARISING FROM, OUT OF OR IN CONNECTION WITH THE SOFTWARE OR THE USE OR OTHER DEALINGS IN THE SOFTWARE.

## PHP 3.01 License

The PHP License, version 3.01 Copyright (c) 1999 - 2010 The PHP Group. All rights reserved.

Component Name	License	URL
php-5.2.17	PHP 3.01	<a href="http://www.php.net/distributions">http://www.php.net/distributions</a>

Redistribution and use in source and binary forms, with or without modification, is permitted provided that the following conditions are met:

1. Redistributions of source code must retain the above copyright notice, this list of conditions and the following disclaimer.
2. Redistributions in binary form must reproduce the above copyright notice, this list of conditions and the following disclaimer in the documentation and/or other materials provided with the distribution.
3. The name "PHP" must not be used to endorse or promote products derived from this software without prior written permission. For written permission, please contact [group@php.net](mailto:group@php.net).
4. Products derived from this software may not be called "PHP", nor may "PHP" appear in their name, without prior written permission from [group@php.net](mailto:group@php.net). You may indicate that your software works in conjunction with PHP by saying "Foo for PHP" instead of calling it "PHP Foo" or "phpfoo".
5. The PHP Group may publish revised and/or new versions of the license from time to time. Each version will be given a distinguishing version number. Once covered code has been published under a particular version of the license, you may always continue to use it under the terms of that version. You may also choose to use such covered code under the terms of any subsequent version of the license published by the PHP Group. No one other than the PHP Group has the right to modify the terms applicable to covered code created under this License.
6. Redistributions of any form whatsoever must retain the following acknowledgment: "This product includes PHP software, freely available from <http://www.php.net/software/>".

THIS SOFTWARE IS PROVIDED BY THE PHP DEVELOPMENT TEAM "AS IS" AND ANY EXPRESSED OR IMPLIED WARRANTIES, INCLUDING, BUT NOT LIMITED TO, THE IMPLIED WARRANTIES OF MERCHANTABILITY AND FITNESS FOR A PARTICULAR PURPOSE ARE DISCLAIMED. IN NO EVENT SHALL THE PHP DEVELOPMENT TEAM OR ITS CONTRIBUTORS BE LIABLE FOR ANY DIRECT, INDIRECT, INCIDENTAL, SPECIAL, EXEMPLARY, OR CONSEQUENTIAL DAMAGES (INCLUDING, BUT NOT LIMITED TO, PROCUREMENT OF SUBSTITUTE GOODS OR SERVICES; LOSS OF USE, DATA, OR PROFITS; OR BUSINESS INTERRUPTION) HOWEVER CAUSED AND ON ANY THEORY OF LIABILITY, WHETHER IN CONTRACT, STRICT LIABILITY, OR TORT (INCLUDING NEGLIGENCE OR OTHERWISE) ARISING IN ANY WAY OUT OF THE USE OF THIS SOFTWARE, EVEN IF ADVISED OF THE POSSIBILITY OF SUCH DAMAGE.

This software consists of voluntary contributions made by many individuals on behalf of the PHP Group. The PHP Group can be contacted via Email at [group@php.net](mailto:group@php.net).

For more information on the PHP Group and the PHP project, please see <http://www.php.net>. PHP includes the Zend Engine, freely available at <http://www.zend.com>.

## zlib / libpng License

This software is provided 'as-is', without any express or implied warranty. In no event will the authors be held liable for any damages arising from the use of this software.

Component Name	License	URL
zlib-1.2.8	zlib / libpng	<a href="http://zlib.net/">http://zlib.net/</a>

Copyright (C) 1995-2010 Jean-loup Gailly and Mark Adler

Permission is granted to anyone to use this software for any purpose, including commercial applications, and to alter it and redistribute it freely, subject to the following restrictions:

1. The origin of this software must not be misrepresented; you must not claim that you wrote the original software. If you use this software in a product, an acknowledgment in the product documentation would be appreciated but is not required.
2. Altered source versions must be plainly marked as such, and must not be misrepresented as being the original software.
3. This notice may not be removed or altered from any source distribution.

Jean-loup Gailly Mark Adler

[jloup@gzip.org](mailto:jloup@gzip.org) [madler@alummi.caltech.edu](mailto:madler@alummi.caltech.edu)

The data format used by the zlib library is described by RFCs (Request for Comments) 1950 to 1952 in the files <http://www.ietf.org/rfc/rfc1950.txt> (zlib format), [rfc1951.txt](http://www.ietf.org/rfc/rfc1951.txt) (deflate format) and [rfc1952.txt](http://www.ietf.org/rfc/rfc1952.txt) (gzip format).



Hanwha Techwin respeta el medio ambiente durante todo el proceso de fabricación de sus productos y realiza una serie de procedimientos orientados a ofrecer productos ecológicos.

El símbolo Eco representa el compromiso de Hanwha Techwin de fabricar productos que respeten el medio ambiente e indica a la vez que este equipo cumple con la Directiva de la Unión Europea EU RoHS.



### Eliminación correcta de este producto (Residuos de aparatos eléctricos y electrónicos)

(Aplicable en la Unión Europea y en países europeos con sistemas de recogida selectiva de residuos)

La presencia de este símbolo en el producto, accesorios o material informativo que lo acompañan, indica que al finalizar su vida útil ni el producto ni sus accesorios electrónicos (como el cargador, cascos, cable USB) deberán eliminarse junto con otros residuos domésticos. Para evitar los posibles daños al medio ambiente o a la salud humana que representa la eliminación incontrolada de residuos, separe estos productos de otros tipos de residuos y reciclelos correctamente. De esta forma se promueve la reutilización sostenible de recursos materiales.

Los usuarios particulares pueden contactar con el establecimiento donde adquirieron el producto o con las autoridades locales pertinentes para informarse sobre cómo y dónde pueden llevarlo para que sea sometido a un reciclaje ecológico y seguro.

Los usuarios comerciales pueden contactar con su proveedor y consultar las condiciones del contrato de compra. Este producto y sus accesorios electrónicos no deben eliminarse junto a otros residuos comerciales.



### Eliminación correcta de las baterías de este producto

(Aplicable en la Unión Europea y en otros países europeos con sistemas de recogida selectiva de baterías.)

La presencia de esta marca en las baterías, el manual o el paquete del producto indica que cuando haya finalizado la vida útil de las baterías no deberán eliminarse junto con otros residuos domésticos. Los símbolos químicos Hg, Cd o Pb, si aparecen, indican que la batería contiene mercurio, cadmio o plomo en niveles superiores a los valores de referencia admitidos por la Directiva 2006/66 de la Unión Europea. Si las baterías no se desechan convenientemente, estas sustancias podrían provocar lesiones personales o dañar el medioambiente.

Para proteger los recursos naturales y promover el reciclaje, separe las baterías de los demás residuos y reciclelas mediante el sistema de recogida gratuito de su localidad.

---

**Head Office**

6, Pangyo-ro 319 beon-gil, Bundang-gu, Seongnam-si,  
Gyeonggi-do, 463-400 Rep. of KOREA  
Tel : +82.70.7147.8753 Fax : +82.31.8018.3740  
[www.hanwha-security.com](http://www.hanwha-security.com)

---

**Hanwha Techwin America**

500 Frank W. Burr Blvd. Suite 43 Teaneck, NJ 07666  
Toll Free +1.877.213.1222 Direct +1.201.325.6920  
Fax +1.201.373.0124  
[www.hanwhasecurity.com](http://www.hanwhasecurity.com)

---

**Hanwha Techwin Europe**

Heriot House, Heriot Road, Chertsey, Surrey, KT16 9DT, United Kingdom  
Tel +44.1932.57.8100 Fax +44.1932.57.8101  
[www.hanwha-security.eu](http://www.hanwha-security.eu)

---