

**Approximate Operating Distances (mm)
on Non Ferrous Surfaces**

X	Min Close	12mm
	Max Open	35mm
Y	Min Close	10mm
	Max Open	33mm

Mounting on a ferrous surface will reduce these figures, dependant on the material and thickness.

Specifications

Switch		Housing	
Contact Material:	Rhodium & Ruthenium	Material:	High Impact Polystyrene
Contact Rating:	500mA @ 12Vdc	Contact Dimension (mm):	85 x 25 x 21
Contact Resistance:	100 milliOhms	Contact Fixing (mm):	72mm centres
Temperature Range:	-15° C to +40° C	Magnet Dimension (mm):	85 x 18 x 21
Life Expectancy:	>1,000,000 cycles	Magnet fixing (mm)	40 centres

Environmental Advice.

This product is covered by current WEEE regulations. Please consider the effect on the environment when disposing of it. Do not put in a domestic waste bin. Only dispose of at an appointed recycling centre.



RoHS compliant.

This product is designed to meet the requirements of EN50131-2-6:2008
Security grade 3 , environmental class II



SC570*/G3/EN Magnetic Surface Contact.

* colour varies

Surface mounted magnetic contact.

6 terminals.

Configurable as double pole or end of line.

Separate tamper circuit.

Separate magnetic interference circuit.

Suitable for domestic and commercial alarm circuits.

Suitable for double door applications.

Can be used in installations up to and including grade 3.

High impact polymer construction.

Operating and Installation Instructions

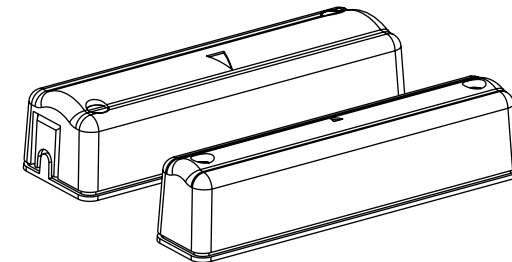

Description

This contact is a modern stylish magnetic door contact that can be used in most security systems up to and including grade 3 as specified in EN50131-1: 2006 and is certified to EN50131-2-6:2008 and environmental class II (for use indoors) by Telefication. It operates as a normally closed circuit going open when the magnet housing is moved away from the contact housing. This contact can be used on windows and doors to detect the unauthorised entry of an intruder. A number of applications are shown below. The contact is also protected against tampering with the an option of detection of removal from its mounting surface if required. Additionally there is a magnetic interference detection circuit for signalling the proximity of a magnet, which typically would be used by an intruder trying to inhibit the performance of the contact.

CQR Security. 125, Pasture Road, Moreton, Wirral. CH46 4TH, United Kingdom

Tel: +44 (0) 151 606 9595 Support: +44 (0) 151 606 6311 email: info@cqr.co.uk Web <http://www.cqr.co.uk>

Features

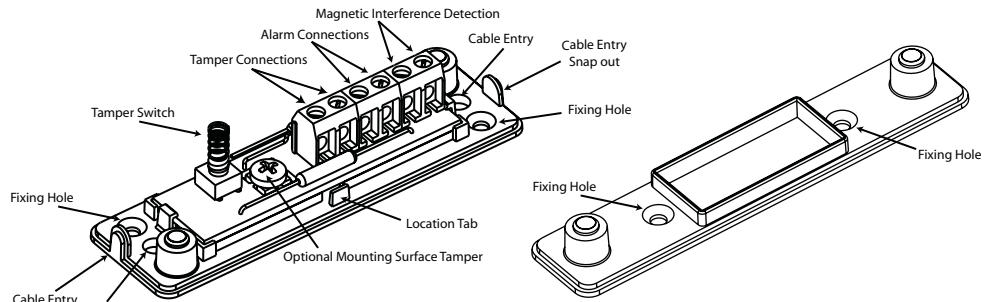

Contact Housing

Magnet Housing

Suitable Applications and Fixing Points

Recommended fixing points ↘

Casement Windows

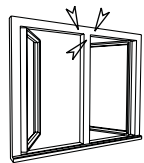

Factory Windows



Patio Doors

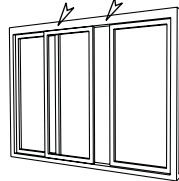

Residential Doors

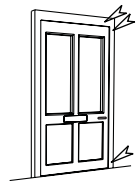

Sash Windows

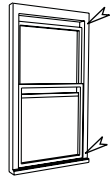

Wood Awning Windows

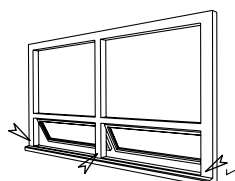

Mounting Instructions

Mount the contact housing using the fixing holes as shown in the diagram. Please see the mounting configurations to ensure that the contact is mounted in the most suitable configuration for the location. Please note that the location tab on the contact housing indicates the direction towards the magnet case.

If removal from wall tamper is required, use the extra screw provided and insert into the hole as shown. This is designed to break the circuit board and is irreversible. Please note that in the case of forcible removal from the wall, the contact will need to be replaced.

Two cable entries are provided at either end, snap out the appropriate section to allow for the cable entry. There are also holes at either end to allow for rear cable entry, as well as a hole behind the circuit board. To remove the circuit board, carefully pull back the retaining clips to release the board. To refit, reverse the procedure.

Mount the magnet housing by removing the cover and use the two available screw holes. In the event of the magnet housing affecting the magnetic interference detection circuit, we advise moving the magnet further away so that only the alarm switch is activated in normal operation.

Mounting Configurations

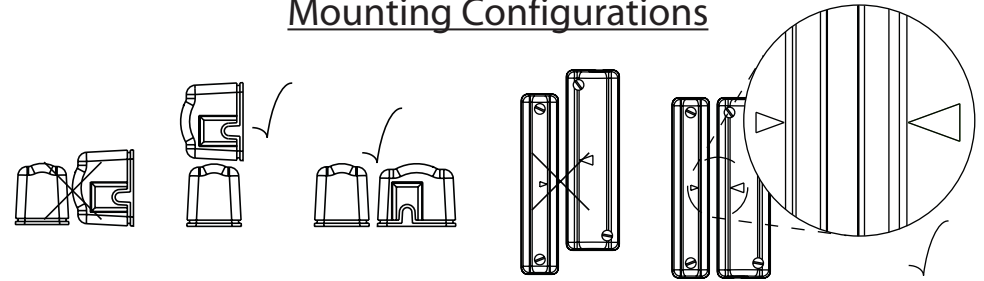

Wiring Configurations

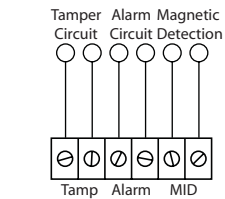

Double pole configuration

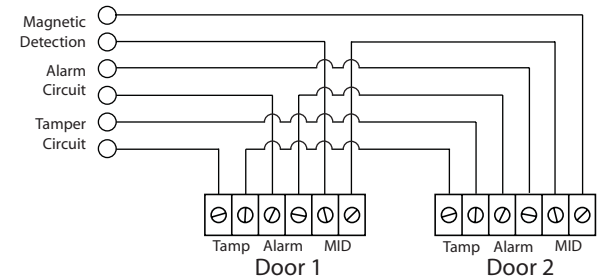

Double pole, double door configuration

Alarm Circuit

R1 = Tamper
R2 = Alarm

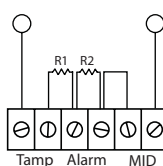

Fully supervised configuration.
R1 and R2 to suit the control panel.

R1 = Tamper
R2 = Alarm

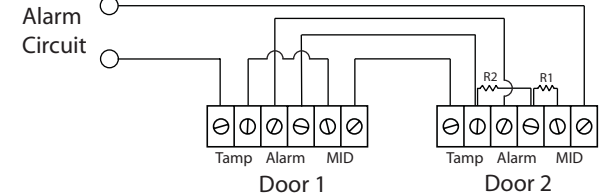

Fully supervised, double door configuration, R1 and R2 to suit control panel