

Single Zone Expander (RP128EZ01)

The RISCO RP128EZ01 is a Single Zone Expander that enables to connect any detector to RISCO system BUS. Using the BUS connection you can ease your installation by connecting any detector in parallel connections from any point along the wiring route. In addition you can define any detector with one of the following zone terminations supported by the panel: NO, NC, EOL, DEOL, TEOL.

The following instructions explain how to connect to the RP128EZ01 the ProSYS.

Notes:

1. Up to 32 Single Zone Expanders can be installed on the ProSYS main BUS.
2. Up to 128 Single Zone Expanders can be assigned to the ProSYS using the BUS Zone Expander.

The following instructions explain how to connect a detector to the ProSYS BUS using the RP128EZ01.

Installation

1. Set the RP128EZ01 ID number (1-32) using DIP switches 1-5.
 - SW1 (1 - 5): ID switches. Defines the Single BUS Zone Expander ID number
 - SW1 - 6: Not used

ID	DIP - 1	DIP - 2	DIP - 3	DIP - 4	DIP - 5
1	Off	Off	Off	Off	Off
2	On	Off	Off	Off	Off
3	Off	On	Off	Off	Off
4	On	On	Off	Off	Off
5	Off	Off	On	Off	Off
6	On	Off	On	Off	Off
7	Off	On	On	Off	Off
8	On	On	On	Off	Off
9	Off	Off	Off	On	Off
10	On	Off	Off	On	Off
11	Off	On	Off	On	Off
12	On	On	Off	On	Off
13	Off	Off	On	On	Off
14	On	Off	On	On	Off
15	Off	On	On	On	Off
16	On	On	On	On	Off

ID	DIP - 1	DIP - 2	DIP - 3	DIP - 4	DIP - 5
17	Off	Off	Off	Off	On
18	On	Off	Off	Off	On
19	Off	On	Off	Off	On
20	On	On	Off	Off	On
21	Off	Off	On	Off	On
22	On	Off	On	Off	On
23	Off	On	On	Off	On
24	On	On	On	Off	On
25	Off	Off	Off	On	On
26	On	Off	Off	On	On
27	Off	On	Off	On	On
28	On	On	Off	On	On
29	Off	Off	On	On	On
30	On	Off	On	On	On
31	Off	On	On	On	On
32	On	On	On	On	On

2. Wire the RP128EZ01 BUS wires Red, Black (COM), Yellow(BUS) and Green (BUS) to the ProSYS BUS.

Notes:

For maximum operation stability, it is best NOT to exceed a total of 300 meters (1000 feet) of wiring from the ProSYS BZ1 to the ProSYS panel or to the BUS Zone Expander.

- **Wiring RP128EZ01 to the Main BUS**

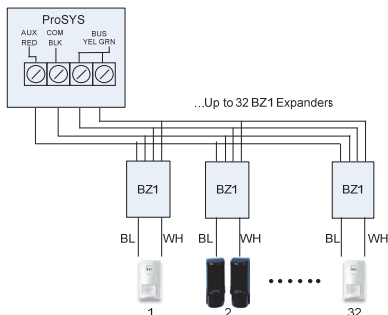

➤ Wiring RP128EZ01 to BUS Zones Expanders

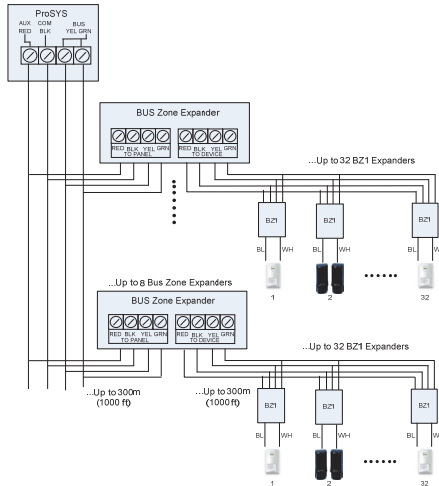

Notes:

When connecting RP128EZ01 to a **BUS Zone Expander** wire the RP128EZ01 wires to the relevant BUS zone expander's terminals marked as **TO DEVICE**.

3. Wire the RP128EZ01 zone wires, Black and White, to the detector's terminals according to the required termination.

Notes:

The Black and White wires are equivalent to zone input terminals in the ProSYS.

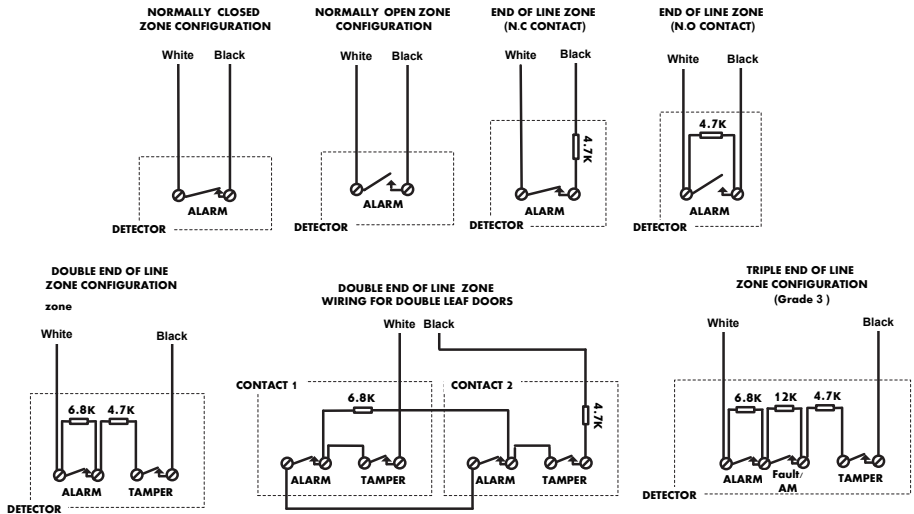



Programming

The following section describes the programming flow for the RP128EZ01 when connected to the ProSYS. The RP128EZ01 should be configured in the system as an input zone of an iWISE Quad BUS Detector (iQUG3).

Programming a RP128EZ01 that is wired to the Main BUS



Step 1: Adding RP128EZ01 to the Main Unit

QUICK KEYS = [7][1][9][5]:

1. From the main installer menu press [7][1][9][5] to access the BUS Zone category.
2. Using the / keys select the ID number as set by the RP128EZ01's DIP switches (01-32)

Note:

The bottom line in the display shows "(0:yy) Type: None". In the 0:yy designation, the 0 represents that the RP128EZ01 is on the main unit and is not assigned to a BUS Zone Expander. The yy represents the RP128EZ01 ID number (up to 32) as set by its DIP switches.

3. Using the / keys move to the Type field. Use the  key to select the iQUG3 type.
4. Repeat steps 2 and 3 for other RP128EZ01 Expanders.

Note:





If required you can add virtual zones to the system and assign the RP128EZ01 to these zones. Virtual zones are cost effective. They enable to use up to 32 RP128EZ01 Expanders on the main unit without adding physical zone expanders. To add a Virtual BUS zone expander select type VBZ08 or VBZ16 when adding a zone expander (Quick key [7][1][2]).

Step 2: Assign RP128EZ01 to a Zone ID and set its parameters

The RP128EZ01 should be configured in the system as the input of the iWISE Quad BUS detector (iQUG3).







Note:

The parameters of the RP128EZ01 are the same as any other regular wired zone in the system, with the exception that it should be linked to one of the zones in the system.

1. From the main installer menu press [2] to enter the Zones menu.
2. Using the / keys, select [ONE BY ONE] and press .
3. Using the numeric keys, enter the desired zone number and press .

Note:







You can select any zone number that is not defined on a Wireless Zone Expander or a BUS Zone Expander.

4. Press  to access the Partitions category.
5. Define Partitions, Groups, Zone Type and Zone Sound.
6. In the Termination category select one of the following options: BUS Zone Input N/C, BUS Zone Input EOL, BUS Zone Input DEOL, BUS Zone Input N/O, BUS Zone Input TEOL. Press .
7. Press . Select the iQUG3 (0:yy) that the ProSYS BZ1 belongs to. The Type field will be updated automatically when selecting the zone.
8. Press . Define the loop response time.
9. Press , assign a label and press .
10. Repeat steps 3-10 for all required ProSYS BZ1 expanders.

Programming a RP128EZ01 Wired to a BUS Zone Expander

Step 1: Adding the BUS Zone Expander to ProSYS

QUICK KEYS = [7][1][2]









1. From the main installer menu press [7][1][2] to enter the Add BUS zone expander menu.
2. Using the  /  keys select a BUS Zone Expander ID.
3. Using the  /  keys move to Type. Use the  key to select a type (BZE08, BZE16, BZE24 or BZE32 zone expander) based on the DIP switches you set on the expander. Press .
4. Using the  key, select type iQUG3 for any RP128EZ01 connected to this BUS zone expander.

Note:

The display shows "(x:yy) Type: None". In the x:yy designation, the x represents the BUS Zone Expander ID number and the yy represents the RP128EZ01 ID number that is connected to the zone expander, as set by the RP128EZ01's DIP switches.

5. Press  to move to the next RP128EZ01.

Step 2: Assign BUS Detectors to a Zone ID and set basic parameters

1. From the main installer menu press [2] to enter the Zones menu.
2. Using the  /  keys, select [ONE BY ONE] and press .
3. Using the numeric keys, select a zone number whose designation (x:yy) is equivalent to the one defined for the ProSYS BZ1. (The x represents the BUS Zone Expander ID number and the yy represents the ProSYS BZ1 ID number as set by its ID DIP switches). Press  to access the Partitions category.
4. Define Partitions, Groups, Zone Type and Zone Sound.
5. In the Termination category select one of the following options: BUS Zone Input N/C, BUS Zone Input EOL, BUS Zone Input DEOL, BUS Zone Input N/O, BUS Zone Input TEOL. Press .
6. Press . Select the iQUG3 (x:yy) that the RP128EZ01 belongs to. The Type field will be updated automatically when selecting the zone.
7. Press . Define the loop response time.
8. Press  assign a label and press .
9. Repeat steps 3-10 for all required RP128EZ01 expanders

Technical Specifications

Power Supply	13.8V
Current Consumption	20mA
Operating Temperature	-10° - 55° C (14° F – 131° F)

EMC Statement

Hereby, RISCO Group declares that this equipment is in compliance with the essential requirements and other relevant provisions of Directive 2014/30/EU.

For the CE Declaration of Conformity please refer to our website: www.riscogroup.com.

Contacting RISCO Group

RISCO Group is committed to customer service and product support. You can contact us through our website www.riscogroup.com or as follows:

United Kingdom Tel: +44-161-655-5500 support-uk@riscogroup.com	France Tel: +33-164-73-28-50 support-fr@riscogroup.com	Italy Tel: +39-02-66590054 support-it@riscogroup.com	Belgium (Benelux) Tel: +32-2522-7622 support-be@riscogroup.com
China (Shanghai) Tel: +86-21-52-39-0066 support-cn@riscogroup.com	Spain Tel: +34-91-490-2133 support-es@riscogroup.com	USA Tel: +1-631-719-4400 support-usa@riscogroup.com	Israel Tel: +972-3-963-7777 support@riscogroup.com

All rights reserved.

No part of this document may be reproduced in any form without prior written permission from the publisher.

© RISCO Group 12/2018

5IN110 B