

**ROSHNI LP (ROLP)**  
**ROSHNI LP (ROLP/SV)**



**CE** **e**  
ROLP : 0832-CPD-0128  
ROLP/SV : 0832-CPD-1651

EN54-3 Fire Alarm Device - Sounder  
Dispositif d'alarme incendie EN54-3 – Avertisseur d'incendie  
EN54-3 Feueralarmgerät – Töner  
Dispositivo di allarme antincendio a norma EN54-3 - Sirena  
EN54-3 Brandalarm – sounder  
Dispositivo de alarma de incendios EN54-3 – Timbre de alarma  
EN54-3 Brandvarnare – Signalgivare  
EN54-3 Urządzenie systemów SAP - Sygnalizator

EN54-3	ROLP ROLP/SV
18 ~ 28 VDC 9 ~ 15VDC	9 ~ 28Vdc
32mA max	
0.28mm <sup>2</sup> - 2.5mm <sup>2</sup>	
-25 °C - +70 °C	
ABS V0	
S = Type A = (IP54*) D/U = Type B = (IP65*)	
6	32

\*Product exceeds minimum requirements of EN54-3  
See www.cooperfulleon.com  
Le produit dépasse les exigences minimum de EN54-3  
Voir www.cooperfulleon.com  
Das Erzeugnis erfüllt die Mindestanforderungen von EN54-3.  
Siehe www.cooperfulleon.com  
Il prodotto supera i requisiti minimi previsti dalla norma EN54-3  
Vedi www.cooperfulleon.com  
Product overtreft de minimale vereisten van EN54-3.  
Zie www.cooperfulleon.com  
El producto excede los requisitos mínimos de la norma EN54-3  
Véase www.cooperfulleon.com  
Produkten överträffar minsta krav enligt EN54-3  
Se www.cooperfulleon.com  
Parametry techniczne produktu przekraczają minimalne  
wymagania normy PN EN54-3, szczególnie www.cooperfulleon.com

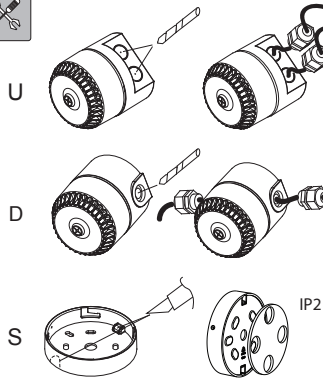
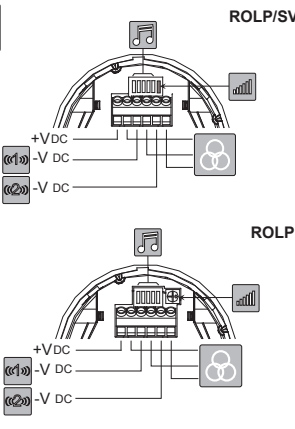
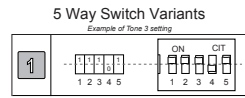
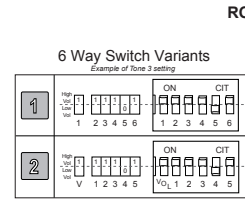
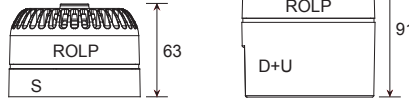
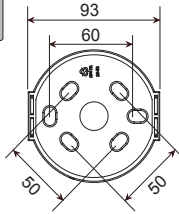

Installation must be in accordance with relevant national wiring regulations or codes for the intended application and voltages employed.  
L'installation doit être conforme à la réglementation ou aux codes nationaux de câblage en vigueur, en vue de l'application désirée et des tensions utilisées.  
Das Gerät ist für die vorgesehene Anwendung und verwendete Spannung gemäß relevanten Bundesvorschriften und Regeln zur Verklebung zu installieren.  
L'installazione deve essere eseguita in conformità con le disposizioni nazionali vigenti sul cablaggio o i corrispondenti codici per l'applicazione prevista e le tensioni impiegate.  
Instalatie moet overeenstemmen met relevante nationale wetgeving of codes voor kabels bij de bedoelde toepassingen en gebruikte voltages.  
La instalación debe estar acorde con las principales normas nacionales para cableado o códigos para la aplicación prevista y los voltajes empleados.  
Installation måste ske i enlighet med landets gällande lagar eller bestämmelser för dragnag av elektriska kablar till den avsedda enheten och den aktuella spänningen.  
Instalacja musi być wykonana zgodnie z obowiązującymi przepisami prawa i wytycznymi zgodnie z przeznaczaniem sygnalizatora i z wartością zastosowanych napięć.

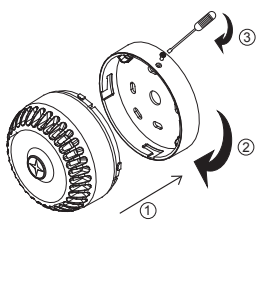
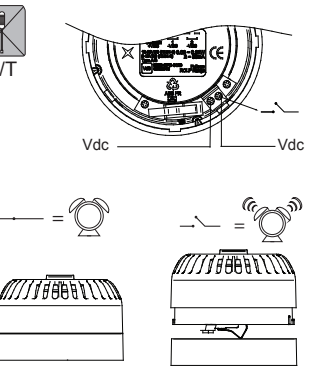

							Main Application	Roshni LP (ROLP)					
								mA	dB(A)	EN54-3 15Vdc see notes	mA	dB(A)	EN54-3 28Vdc see notes
1	14	11111	Alternating	800 & 970	2Hz (250ms-250ms)		BS Fire	6	95	*	13	101	*
2	14	11110	Sweep	800 to 970	7Hz (7/s)		BS Fire	8	94	*	12	100	*
3	14	11101	Sweep	800 to 970	1Hz (1/s)		BS Fire	6	95	92	12	102	95
4	14	11100	Continuous	2850	Steady		General Purpose	16	99	*	32	105	*
5	4	11011	Sweep	2400 to 2850	7Hz		General Purpose	16	100	*	32	109	*
6	4	11010	Sweep	2400 to 2850	1Hz		General Purpose	16	105	*	32	112	*
7	14	11001	Slow whoop	500 to 1200	3s sweep, 0.5 s silence, then repeat		Dutch fire (NEN 2575)	6	97	93	12	103	97
8	14	11000	Sweep (DIN)	1200 to 500	1Hz		German fire (DIN 33 404)	7	96	93	15	103	94
9	4	10111	Alternating	2400 & 2850	2Hz (250ms-250ms)		General Purpose	15	99	*	31	105	*
10	14	10110	Intermittent	970	0.5Hz (1s On/1s Off)		PFEER alert	5	95	*	13	101	*
11	14	10101	Alternating	800 & 970	1Hz (500ms-500ms)		BS Fire	6	95	*	12	101	*
12	4	10100	Intermittent	2850	0.5Hz (1s On/1s Off)		General Purpose	16	99	*	28	105	*
13	14	10011	Intermittent	970	0.8Hz (250ms On/1s Off)		General Purpose	6	94	*	11	101	*
14	14	10010	Continuous	970	Steady		PFEER toxic gas	7	95	93	14	101	95
15	14	10001	Alternating	554 & 440	100ms-400ms		French fire (NFS 32-001)	8	96	*	17	102	*
16	16	10000	Intermittent	660	3.3Hz (150ms On/150ms Off)		Swedish (Air Raid)	6	94	*	10	100	*
17	17	01111	Intermittent	660	0.28Hz (1.8s On/1.8s Off)		Swedish (Local warning)	6	95	*	10	101	*
18	18	01110	Intermittent	660	0.05Hz (13s Off / 6.5Hz On)		Swedish (Pre-mess)	5	95	*	10	101	*
19	19	01101	Continuous	660	Steady		Swedish (All clear)	5	95	*	10	101	*
20	20	01100	Alternating	554 & 440	0.5Hz (1s On/1s Off)		Swedish (Turn out)	7	96	*	16	102	*
21	21	01011	Intermittent	660	1Hz (500ms-500ms)		Swedish general purpose	7	94	*	10	101	*
22	14	01010	Intermittent	2850	4Hz (150ms On/100ms Off)		Pelican crossing	12	98	*	27	104	*
23	14	01001	Sweep	800 to 970	50Hz		BS Fire	6	93	*	12	100	*
24	4	01000	Sweep	2400 to 2850	50Hz		General Purpose	15	102	*	32	108	*
25	25	00111	Intermittent	970	3 x 500ms pulses, 1.5s silence, then repeat		ISO 8201	6	95	*	10	101	*
26	26	00110	Intermittent (I*)	800 to 970	3 x 500ms pulsed sweep, 1.5s silence, then repeat		ISO 8201	6	95	*	10	102	*
27	27	00101	Intermittent (I*)	970 & 800	3 x 500ms pulsed sweep, 1.5s silence, then repeat		ISO 8201	5	94	*	10	101	*
28	10	00100	Alternating	800 & 970	2Hz (250ms-250ms)		BS Fire	6	95	*	12	101	*
29	988Hz	00011	Alternating	990 & 650	2Hz (250ms-250ms) (Symphoni tones)		BS Fire	10	99	93	20	105	96
30	510Hz	00010	Alternating	510 & 610	2Hz (250ms-250ms) (Squashni Micro tones)		BS Fire	8	94	91	16	100	92
31	14	00001	Sweep	300 to 1200	1Hz		General Purpose	10	98	*	14	103	*
32	510Hz	00000	Alternating	510 & 610	1Hz (500ms-500ms)		BS Fire	8	95	*	16	100	*

(i) Tones certified under the CPD (Fire Alarm Applications) are shown in the column marked EN54-3  
(ii) All other SPL measurements are taken 'on axis' & are not third party verified.  
(iii) Detailed EN54-3 polar SPL measurements are available in M96-024  
(iii) A SPL of at least 65dB(A) is achieved in at least one direction at minimum volume/voltage.  
(i) Les tons certifiés dans le cadre de la DPC (application alarme incendie) sont indiqués dans la colonne intitulée EN54-3.  
(ii) Toutes les autres mesures NPA sont relevées « sur axe » et ne sont pas vérifiées par un tiers.  
(iii) Les mesures NPA polaires détaillées EN54-3 sont disponibles dans M96-024  
(i) Die nach CPD (Feuermeldernwendung) zertifizierten Töne sind in Spalte EN54-3.  
(ii) Alle anderen Schalldruckmessungen wurden vom akustischen Mittelpunkt ab gelesen und von keiner unabhängigen Stelle verifiziert.  
(iii) Detaillierte Polar-SPL-Messungen gemäß EN54-3 sind erhältlich in M96-024  
(i) I toni della sirena certificati CPD (applicazione allarme antincendio) sono indicate nella colonna contrassegnata con EN54-3.  
(ii) Tutte le altre misurazioni SPL sono state rilevate "sull'asse" e non sono state verificate da terzi.  
(iii) Le misurazioni SPL polari ai sensi della norma EN54-3 sono disponibili in M96-024  
(i) U vindt tonen die onder CPD (brandalarmtoepassing) zijn gecertificeerd, in de kolom waar EN54-3 staat vermeld.  
(ii) Alle andere SPL-metingen zijn via de 'as' gedaan en niet door derden geverifieerd.  
(iii) Uitgebreide polaire SPL-metingen voor EN54-3 zijn beschikbaar in M96-024

(i) Los sonidos certificados por el CPD (aplicación para alarmas de incendios) se muestran en la columna marcada con EN54-3.  
(ii) Cualquier otra medida del SPL (nivel de intensidad acústica) se toma "sobre el eje" y no está verificada por terceras partes.  
(iii) Las medidas detalladas del SPL polar EN54-3 están disponibles en M96-024  
(i) Signaler som är certifierade för CPD (brandvarnare) visas i kolumnen märkt EN54-3.  
(ii) Alla övriga mätningar av ljudtrycket har genomförts "direkt intill" och är inte bekräftade av tredje part.  
(iii) Detaljerade polära mätningar av ljudtrycket enligt EN54-3 finns under M96-024  
(i) Sygnaly tonowe zgodne z certyfikatem CPD dla systemów sygnalizacji pożaru wskazane są w kolumnie EN54-3.  
(ii) Wszystkie pomiary SPL są wykonane w osi sygnalizatora i nie były poddane weryfikacji przez inną stronę.  
(iii) Szczegółowe pomiary kątowych SPL wg EN54-3 dostępne są w M96-024  
CE marking under the CPD was affixed on: (see batch code on product)  
La marque CE dans le cadre de la DPC a été apposée le: (voir code de lot sur le produit)  
CE-Kennzeichnung unter dem CPD angebracht am: (siehe Chargencode am Erzeugnis).  
La marcatura CE ai sensi della direttiva CPD è stata apposta su: (vedi codice sul prodotto)  
CE-märkning under CPD fästes på: (se batchcode on het product)  
Oznakowanie CE i CPD zostało naniesione na produkt.  
Fulleon Ltd, Cwmbran, South Wales, U.K.  
www.cooperfulleon.com