

EMC TEST REPORT

Test Report No. : KES-EM-22T0319-R1
Date of Issue : Feb. 24, 2023
Product name : CCTV CAMERA
Model/Type No. : ANE-L6012R
Variant Model : -
Applicant : Hanwha Vision Co., Ltd
Applicant Address : 6, Pangyo-ro 319Beon-gil, Bundang-gu, Seongnam-si,
Gyeonggi-do, Republic of Korea
Manufacturer : 1. HANWHA VISION VIETNAM COMPANY LIMITED
2. D-TECH CO.,LTD.
Manufacturer Address : 1. Lot O-2, Que Vo Industrial Zone extended area,
Nam Son commune, Bac Ninh city, Bac Ninh province, Vietnam
2. 173-25, Saneop-ro, Gwonseon-gu, Suwon-si, Gyeonggi- do,
Korea (Suwon Industrial Complex)
Equipment authorization : **Supplier's Declaration of Conformity**
Date of Receipt : Mar. 15, 2022
Test date : Mar. 16, 2022
Test Results : **In Compliance** **Not in Compliance**

Tested by

Eun Gu, Jeon
EMC Test Engineer

Reviewed by

Dong-Hun, Jang
EMC Technical Manager

This test report is not related to KS Q ISO/IEC 17025 and KOLAS.

This report shall not be reproduced except in full, without the written approval of KES Co., Ltd.
The results shown in this test report refer only to the sample(s) tested unless otherwise stated.
The authenticity of the test report, contact kes@kes.co.kr



KES Co., Ltd.

3701, 40, Simin-daero 365beon-gil,
Dongan-gu, Anyang-si, Gyeonggi-do, 14057, Korea
Tel: +82-31-425-6200 / Fax: +82-31-424-0450
www.kes.co.kr

Report No.:
KES-EM-22T0319-R1
Page (2) of (31)

REPORT REVISION HISTORY

Date	Test Report No.	Revision History
Apr. 05, 2022	KES-EM-22T0319	Issued
Feb. 24, 2023	KES-EM-22T0319-R1	Change the Applicant and manufacturer at the request of the customer

This report shall not be reproduced except in full, without the written approval of KES Co., Ltd. This document may be altered or revised by KES Co., Ltd. personnel only, and shall be noted in the revision section of the document. Any alteration of this document not carried out by KES Co., Ltd. will constitute fraud and shall nullify the document.

This report shall not be reproduced except in full, without the written approval of KES Co., Ltd.
The results shown in this test report refer only to the sample(s) tested unless otherwise stated.
The authenticity of the test report, contact kes@kes.co.kr



TABLE OF CONTENTS

1.0	General Product Description.....	4
1.1	Test Voltage & Frequency	8
1.2	Variant Model Differences	8
1.3	Device Modifications	8
1.4	Equipment Under Test.....	8
1.5	Support Equipments	8
1.6	External I/O Cabling	9
1.7	EUT Operating Mode(s)	9
1.8	Configuration.....	10
1.9	Remarks when standards applied	11
1.10	Calibration Details of Equipment Used for Measurement	11
1.11	Test Facility	11
1.12	Laboratory Accreditations and Listings	11
2.0	Test Regulations.....	12
2.1	Conducted Emissions at Mains Power Ports	13
2.2	Radiated Electric Field Emissions(Below 1 GHz)	14
2.3	Radiated Electric Field Emissions(Above 1 GHz)	15
APPENDIX A – TEST DATA.....		16
	Conducted Emissions at Mains Power Ports.....	16
	Radiated Electric Field Emissions(Below 1 GHz)	18
	Radiated Electric Field Emissions(Above 1 GHz)	20
	Test Setup Photos and Configuration	21
	Conducted Emissions at Mains Power Ports.....	21
	Radiated Electric Field Emissions(Below 1 GHz)	22
	Radiated Electric Field Emissions(Above 1 GHz)	23
	EUT External Photographs	24
	EUT Internal Photographs	25



KES Co., Ltd.

3701, 40, Simin-daero 365beon-gil,
Dongan-gu, Anyang-si, Gyeonggi-do, 14057, Korea
Tel: +82-31-425-6200 / Fax: +82-31-424-0450
www.kes.co.kr

Report No.:

KES-EM-22T0319-R1

Page (4) of (31)

1.0 General Product Description

Main Specifications of EUT are:

	ANE-L6012R
Video	
Imaging Device	1/2.8" CMOS
Resolution	1920x1080, 1280x960, 1280x720, 800x600, 800x448, 720x576, 720x480, 640x480, 640x360
Max. Framerate	H.264 : Max. 30fps/25fps(60Hz/50Hz) MJPEG : Max. 2fps at 1920x1080, Max. 3fps at 1280x960, 1280x720, Max. 10fps at other resolution
NETD	None
Pixel Size	None
Min. Illumination	Color: 0.03Lux(F1.6, 1/30sec) BW : 0Lux (IR LED on)
Video Out	None
Video Transmission Distance	None
Lens	
Focal Length (Zoom Ratio)	3mm fixed focal
Max. Aperture Ratio	F1.6
Angular Field of View	H: 107.7° / V: 59.0° / D: 126.7°
Min. Object Distance	1.1m(3.6ft)
Focus Control	Fixed
Lens Type	None
Mount Type	None
Optional Lens	None
Pan / Tilt / Rotate	
Pan / Tilt / Rotate Range	0°~350° / 0°~67° / 0°~355°
Pan Range	None
Pan Speed	None
Tilt Range	None
Tilt Speed	None
Rotate Range	None
Sequence	None
Preset Accuracy	None
Operational	
Camera Title	Displayed up to 15 characters
Direction Indicator	None
Day & Night	Auto(ICR)
Backlight Compensation	BLC, WDR, SSSDR
Wide Dynamic Range	120dB
Digital Noise Reduction	SSNR
Digital Image Stabilization	None
Defog	None
Motion Detection	4ea, rectangular zones
Privacy Masking	6ea, rectangular zones

This report shall not be reproduced except in full, without the written approval of KES Co., Ltd.
The results shown in this test report refer only to the sample(s) tested unless otherwise stated.
The authenticity of the test report, contact kes@kes.co.kr



KES Co., Ltd.

3701, 40, Simin-daero 365beon-gil,
 Dongan-gu, Anyang-si, Gyeonggi-do, 14057, Korea
 Tel: +82-31-425-6200 / Fax: +82-31-424-0450
 www.kes.co.kr

Report No.:
 KES-EM-22T0319-R1
 Page (5) of (31)

Gain Control	Low / Middle / High
White Balance	ATW / AWC / Manual / Indoor / Outdoor
LDC	Support
Electronic Shutter Speed	Minimum / Maximum / Anti flicker (2~1/12,000sec)
Digital PTZ	None
Video Rotation	Flip, Mirror, Hallway view(90°/270°)
Analytics	Motion detection, Tampering
Business Intelligence	None
Serial Interface	None
Alarm I/O	None
Alarm Triggers	Analytics
Alarm Events	File upload via FTP and e-mail Notification via e-mail SD/SDHC recording at event triggers
Audio Streaming	None
Audio In	None
Audio Out	None
IR Viewable Length	20m(65.62ft)
IR Illuminator (Optional)	None
Water Removal	None
Auto Tracking	None
Coaxial Protocol	None
Color Palettes	None
Radiometry	
Temperature Detect Range	None
Temperature Accuracy	None
Temperature Detection	None
Additional	None
Network	
Ethernet	RJ-45(10/100BASE-T)
Video Compression	H.264: Main/Baseline/High, MJPEG
Audio Compression	None
Smart Codec	WiseStreamII
Video Quality Adjustment	H.264: Target bitrate level control MJPEG: Quality level control
Bitrate Control	H.264: CBR or VBR MJPEG: VBR
Streaming	Unicast(6 users) / Multicast Multiple streaming (Up to 3 profiles)
Protocol	IPv4, IPv6, TCP/IP, UDP/IP, RTP(UDP), RTP(TCP), RTCP, RTSP, NTP, HTTP, HTTPS, SSL/TLS, DHCP, FTP, SMTP, ICMP, IGMP, SNMPv1/v2c/v3(MIB-2), ARP, DNS, DDNS, QoS, UPnP, Bonjour
SIP support (VoIP, Peer-to-peer, SIP/PBX)	None

This report shall not be reproduced except in full, without the written approval of KES Co., Ltd.
 The results shown in this test report refer only to the sample(s) tested unless otherwise stated.
 The authenticity of the test report, contact kes@kes.co.kr



KES Co., Ltd.

3701, 40, Simin-daero 365beon-gil,
 Dongan-gu, Anyang-si, Gyeonggi-do, 14057, Korea
 Tel: +82-31-425-6200 / Fax: +82-31-424-0450
 www.kes.co.kr

Report No.:
 KES-EM-22T0319-R1
 Page (6) of (31)

Security	HTTPS(SSL) Login Authentication Digest Login Authentication IP Address Filtering User access log 802.1X Authentication(EAP-TLS, EAP-LEAP)
Application Programming Interface	ONVIF Profile S/G/T SUNAPI(HTTP API)
General	
Webpage Language	English
Web Viewer	None
Edge Storage	Micro SD/SDHC 1slot 32GB
Memory	512MB RAM, 256MB Flash
Environmental & Electrical	
Operating Temperature / Humidity	-30°C ~ +55°C(-22°F ~ +131°F) / Less than 95% RH * Start up should be done at above -20°C(-4°F)
Storage Temperature / Humidity	-30°C ~ +55°C(-22°F ~ +131°F) / Less than 95% RH
Certification	IP67, IK10
Input Voltage	PoE(IEEE802.3af, Class3)
Power Consumption	Max 6.6W, Typical 4.8W
Mechanical	
Color / Material	White / Plastic, Aluminum
RAL Code	RAL9003
Product Dimensions / Weight	Ø125.0x87.4mm(Ø4.92x3.44"), 630g
Compatible Conduit hole / Gangbox	None / Single, Double, 4" Octagon
Hanging Mount (Dome)	None
Skin Cover	None
Skin Cover (Dome)	None
Weather Cap (Dome)	None
Power Module	None
Backbox	SBV-A14B
DORI (EN62676-4 standard)	
Detect (25PPM/ 8PPF)	28.1m(92.04ft)
Observe (63PPM/ 19PPF)	11.2m(36.82ft)
Recognize (125PPM/ 38PPF)	5.6m(18.41ft)
Identify (250PPM/ 76PPF)	2.8m(9.20ft)
LPR/ANPR/MMCR	
Speed Description	None
Speed limit	None
Min. Forward Distance	None
Max. Forward Distance	None
Max. Horizontal Angle	None
Max. Vertical Angle	None
Horizontal Offset	None
Camera Height	None
Lane Coverage	None

This report shall not be reproduced except in full, without the written approval of KES Co., Ltd.
 The results shown in this test report refer only to the sample(s) tested unless otherwise stated.
 The authenticity of the test report, contact kes@kes.co.kr



KES Co., Ltd.

3701, 40, Simin-daero 365beon-gil,
Dongan-gu, Anyang-si, Gyeonggi-do, 14057, Korea
Tel: +82-31-425-6200 / Fax: +82-31-424-0450
www.kes.co.kr

Report No.:
KES-EM-22T0319-R1
Page (7) of (31)

Vehicle Recognition	None
Available Countries	None
Wisenet Road AI LPR/ANPR/MMCR	
Solution	None
Speed Description	None
Lane Coverage	None
Speed limit	None
Min. Forward Distance	None
Max. Forward Distance	None
Max. Horizontal Angle	None
Max. Vertical Angle	None
Horizontal Offset	None
Camera Height	None
Vehicle Recognition	None
Available Countries	None

This report shall not be reproduced except in full, without the written approval of KES Co., Ltd.
The results shown in this test report refer only to the sample(s) tested unless otherwise stated.
The authenticity of the test report, contact kes@kes.co.kr



1.1 Test Voltage & Frequency

Unless indicated otherwise on the individual data sheet or test results, the test voltage and frequency was as indicated below.

AC 120 V, 60 Hz

1.2 Variant Model Differences

Not applicable

1.3 Device Modifications

Not applicable

1.4 Equipment Under Test

Description	Model Number	Serial Number	Manufacturer	Remarks
CCTV CAMERA	ANE-L6012R	-	HANWHA VISION VIETNAM COMPANY LIMITED	EUT

1.5 Support Equipments

Description	Model Number	Serial Number	Manufacturer	Remarks
Notebook	LG15N54	503NZWY038929	LG Electronics.	-
Notebook Adapter	PA-1900-14	OF2R263348701 7764	LITE-ON TECHNOLOGY COPORATION	-
PoE Adapter	PSE156G	-	-	-
Micro SD Card	-	-	-	-



1.6 External I/O Cabling

Start		END		Cable Spec.	
Description	I/O Port	Description	I/O Port	Length	Shield
CCTV CAMERA (EUT)	RJ-45	PoE Adapter	RJ-45	3.0	U
	Micro SD	Micro SD Card	Micro SD	-	-
PoE Adapter	RJ-45	Notebook	RJ-45	1.0	U
Notebook	DC Jack	Notebook Adapter	DC Jack	1.4	S

* Unshielded=U, Shielded=S

1.7 EUT Operating Mode(s)

Test Mode	operating
Operating Mode	Monitoring EUT

EUT Test operating S/W		
Name	Version	Manufacture Company
-	-	-

This report shall not be reproduced except in full, without the written approval of KES Co., Ltd.
The results shown in this test report refer only to the sample(s) tested unless otherwise stated.
The authenticity of the test report, contact kes@kes.co.kr

1.8 Configuration

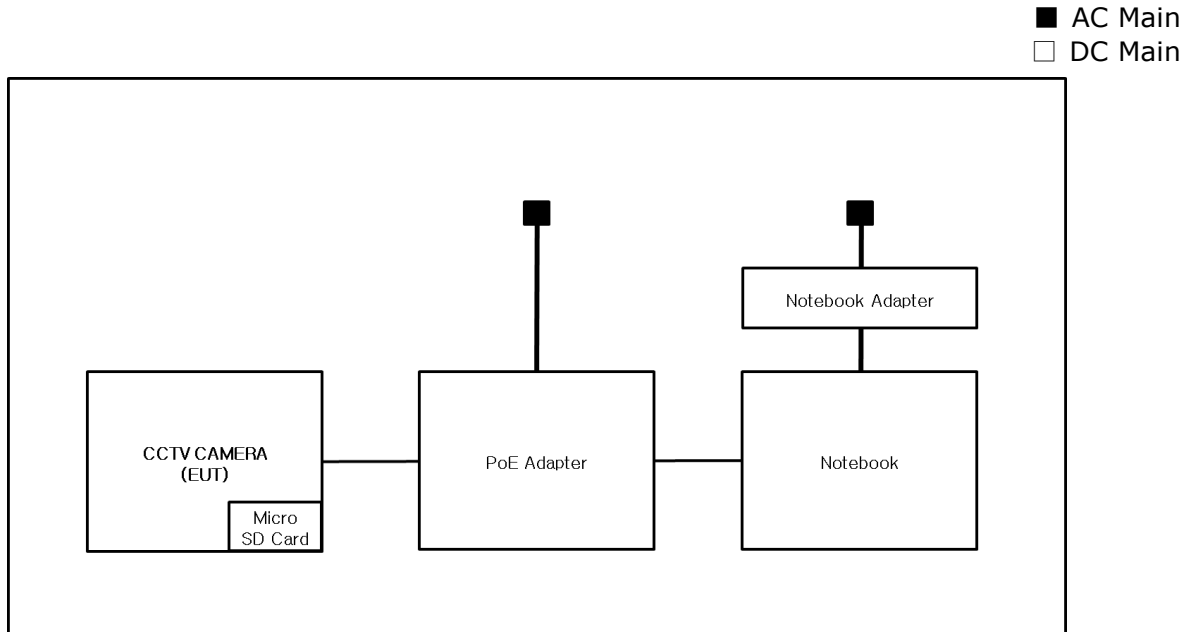

1.9 Remarks when standards applied

N/A







1.10 Calibration Details of Equipment Used for Measurement

Test equipment and test accessories are calibrated on regular basis. The maximum time between calibrations is one year or what is recommended by the manufacturer, whichever is less.

1.11 Test Facility

The measurement facility is located at 473-21, Gayeo-ro, Yeosu-si, Gyeonggi-do, 12658, Korea, Republic of. The sites are constructed in conformance with the requirements of ANSI C63.4a-2017 and CISPR 16-1-4:2019

1.12 Laboratory Accreditations and Listings

Country	Agency	Scope of Accreditation	Logo
KOREA	RRA	EMI (3 m & 10 m Semi-Anechoic Chamber and conducted test site) EMS (ESD, RS, EFT/Burst, Surge, CS, Magnetic, Dips and interruptions)	 KR0100
International	KOLAS	EMI (3 m & 10 m Semi-Anechoic Chamber and conducted test site) EMS (ESD, RS, EFT/Burst, Surge, CS, Magnetic, Dips and interruptions)	 KT489
USA	FCC	3 m & 10 m Semi-Anechoic Chamber Conducted test site to perform FCC Part 15/18 measurements.	 KR0100
Canada	ISED	3 m & 10 m Semi-Anechoic Chamber and Conducted test site	 23298
JAPAN	VCCI	EMI (3 m & 10 m Semi-Anechoic Chamber and conducted test site)	 C-20136, T-20137, R-20181, G-20176
Europe	TÜV SÜD	EMI (3 m & 10 m Semi-Anechoic Chamber and conducted test site) EMS (ESD, RS, EFT/Burst, Surge, CS, Magnetic, Dips and interruptions)	 CARAT 001633 0004

This report shall not be reproduced except in full, without the written approval of KES Co., Ltd.
 The results shown in this test report refer only to the sample(s) tested unless otherwise stated.
 The authenticity of the test report, contact kes@kes.co.kr



2.0 Test Regulations

The emissions tests were performed according to following regulations:

47 CFR Part 15, Subpart B

CISPR 22:2009 +A1:2010 Class A Class B

ANSI C63.4a-2017 Class A Class B

IC Regulation ICES-003 Issue 7

CAN/CSA-CISPR 32:17 Class A Class B

ANSI C63.4a-2017 Class A Class B

2.1 Conducted Emissions at Mains Power Ports

Test Date

Mar. 16, 2022

Test Location

Electro wave Shieldroom #6

Test Equipment

Used	Description	Model Number	Manufacturer	Serial Number	Cal. Due
<input checked="" type="checkbox"/>	EMI Test S/W	EMC32	R & S	9.12.00	-
<input checked="" type="checkbox"/>	EMI TEST RECEIVER	ESR3	R & S	101783	12, 28, 2022
<input checked="" type="checkbox"/>	LISN	ENV216	R & S	101787	12, 27, 2022
<input checked="" type="checkbox"/>	LISN	ESH2-Z5	R & S	100450	12, 27, 2022
<input checked="" type="checkbox"/>	PULSE LIMITER	ESH3-Z2	R & S	101915	12, 27, 2022

Test Conditions

Temperature: (24,4 ± 0,1) °C

Relative Humidity: (43,8 ± 0,1) % R.H.

Frequency Range of Measurement

150 kHz to 30 MHz

Instrument Settings

IF Band Width: 9 kHz

Test Results

The requirements are:

- PASS
 NOT PASS
 NOT APPLICABLE

RemarksSee Appendix A for test data.

2.2 Radiated Electric Field Emissions(Below 1 GHz)

Test Date

Mar. 16, 2022

Test Location OPEN AREA TEST SITE #2 SEMI ANECHOIC CHAMBER #4(10m)**Test Equipment**

Used	Description	Model Number	Manufacturer	Serial Number	Cal. Due
<input checked="" type="checkbox"/>	EMI Test S/W	EP5/RE	TOYO Corporation	6.0.0	-
<input checked="" type="checkbox"/>	EMI TEST RECEIVER	ESU26	R & S	100551	03, 31, 2023
<input checked="" type="checkbox"/>	AMPLIFIER	SCU 01	R & S	100603	11, 24, 2022
<input checked="" type="checkbox"/>	TRILOG-BROADBAND ANTENNA	VULB9163	Schwarzbeck	715	12, 08, 2022
<input checked="" type="checkbox"/>	ATTENUATOR	8491A	HP	32173	03, 08, 2023

Test Conditions

Temperature: (23,8 ± 0,1) °C

Relative Humidity: (42,6 ± 0,2) % R.H.

Frequency Range of Measurement

30 MHz to 1 GHz

Instrument Settings

IF Band Width: 120 kHz

Test Results

The requirements are:

- PASS
 NOT PASS
 NOT APPLICABLE

RemarksSee Appendix A for test data.

2.3 Radiated Electric Field Emissions(Above 1 GHz)

Test Date

Mar. 16, 2022

Test Location

SEMI ANECHOIC CHAMBER #5

Test Equipment

Used	Description	Model Number	Manufacturer	Serial Number	Cal. Due
<input checked="" type="checkbox"/>	EMI Test S/W	EP5/RE	TOYO Corporation	6.0.120	-
<input checked="" type="checkbox"/>	EMI TEST RECEIVER	ESU26	Rohde & Schwarz	100552	03, 31, 2023
<input checked="" type="checkbox"/>	HORN ANTENNA	BBHA 9120D	SCHWARZBECK	9120D-1802	12, 16, 2022
<input checked="" type="checkbox"/>	PREAMPLIFIER	8449B	HP	3008A00538	06, 21, 2022

Test Conditions

Temperature: (24,7 ± 0,1) °C

Relative Humidity: (48,1 ± 0,1) % R.H.

Frequency Range of Measurement

1 GHz to 5 GHz

Instrument Settings

IF Band Width: 1 MHz

Test Results

The requirements are:

- PASS
 NOT PASS
 NOT APPLICABLE

RemarksSee Appendix A for test data.

APPENDIX A – TEST DATA

Conducted Emissions at Mains Power Ports

HOT LINE

Common Information

Test Description:	Conducted Emission
Model No.:	ANE-L6012R
Phase:	
Mode:	L1
Operator Name:	KES

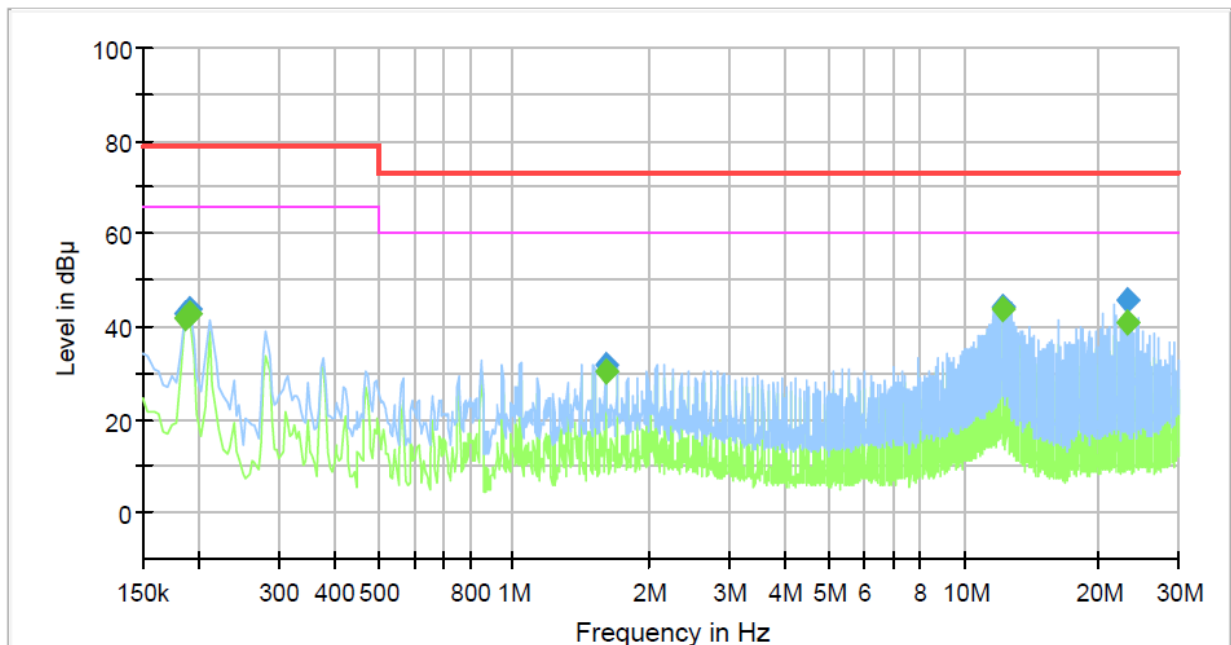

Final Result

Frequency (MHz)	QuasiPeak (dBμV)	CAverage (dBμV)	Limit (dBμV)	Margin (dB)	Meas. Time (ms)	Bandwidth (kHz)	Line	Corr. (dB)
0.186000	---	41.78	66.00	24.22	1000.0	9.000	L1	19.6
0.186000	42.98	---	79.00	36.02	1000.0	9.000	L1	19.6
0.190000	---	42.71	66.00	23.29	1000.0	9.000	L1	19.6
0.190000	43.90	---	79.00	35.10	1000.0	9.000	L1	19.6
1.602000	---	30.57	60.00	29.43	1000.0	9.000	L1	20.4
1.602000	31.94	---	73.00	41.06	1000.0	9.000	L1	20.4
12.246000	---	43.99	60.00	16.01	1000.0	9.000	L1	20.5
12.246000	44.21	---	73.00	28.79	1000.0	9.000	L1	20.5
23.130000	---	40.96	60.00	19.04	1000.0	9.000	L1	20.9
23.130000	45.49	---	73.00	27.51	1000.0	9.000	L1	20.9

This report shall not be reproduced except in full, without the written approval of KES Co., Ltd.
The results shown in this test report refer only to the sample(s) tested unless otherwise stated.
The authenticity of the test report, contact kes@kes.co.kr

NEUTRAL LINE

Common Information

Test Description: Conducted Emission
 Model No.: ANE-L6012R
 Phase:
 Mode: N
 Operator Name: KES

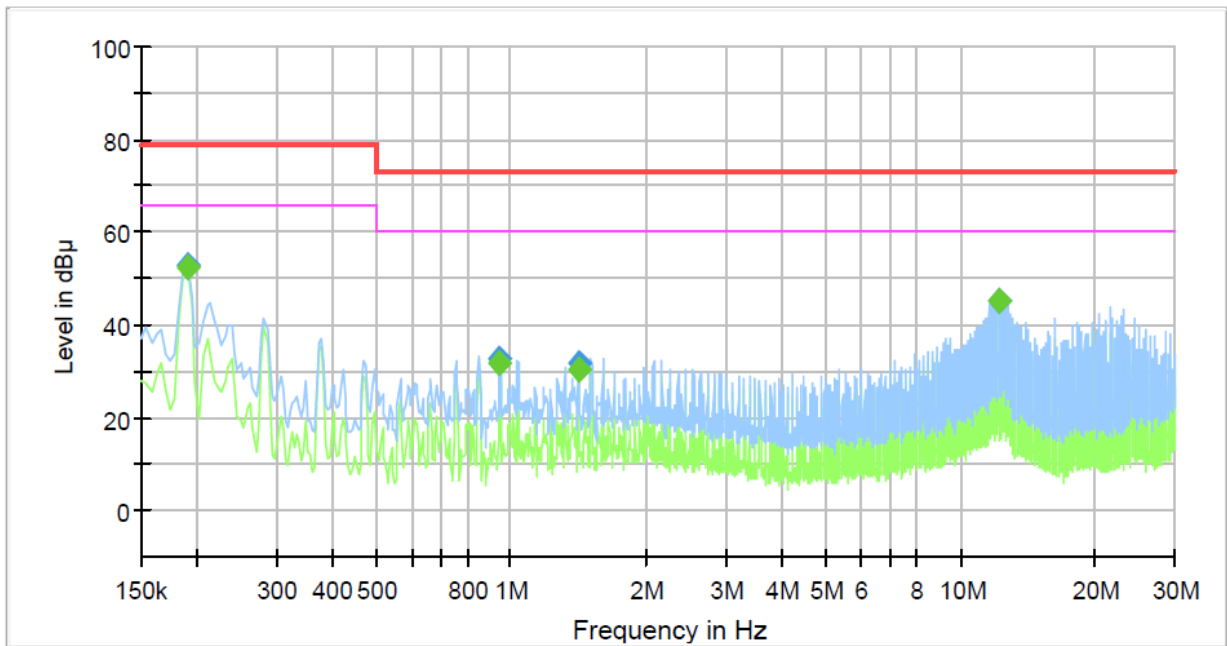

Final Result

Frequency (MHz)	QuasiPeak (dBµV)	CAverage (dBµV)	Limit (dBµV)	Margin (dB)	Meas. Time (ms)	Bandwidth (kHz)	Line	Corr. (dB)
0.190000	---	52.45	66.00	13.55	1000.0	9.000	N	19.5
0.190000	52.92	---	79.00	26.08	1000.0	9.000	N	19.5
0.942000	---	31.56	60.00	28.44	1000.0	9.000	N	20.2
0.942000	32.76	---	73.00	40.24	1000.0	9.000	N	20.2
1.414000	---	30.35	60.00	29.65	1000.0	9.000	N	20.3
1.414000	31.96	---	73.00	41.04	1000.0	9.000	N	20.3
12.246000	---	45.10	60.00	14.90	1000.0	9.000	N	20.4
12.246000	45.35	---	73.00	27.65	1000.0	9.000	N	20.4

◆ Calculation

QuasiPeak [dBuV] / CAverage [dBuV] = Reading Value [dBuV] + Corr. [dB]

QuasiPeak / CAverage : The Final Value

Reading Value : Not shown in the table.

Corr. : Correction values (LISN FACTOR + (Cable Loss + Pulse Limiter FACTOR))

This report shall not be reproduced except in full, without the written approval of KES Co., Ltd.
 The results shown in this test report refer only to the sample(s) tested unless otherwise stated.
 The authenticity of the test report, contact kes@kes.co.kr



KES Co., Ltd.

3701, 40, Simin-daero 365beon-gil,
 Dongan-gu, Anyang-si, Gyeonggi-do, 14057, Korea
 Tel: +82-31-425-6200 / Fax: +82-31-424-0450
 www.kes.co.kr

Report No.:
 KES-EM-22T0319-R1
 Page (18) of (31)

Radiated Electric Field Emissions(Below 1 GHz)

- 47 CFR Part 15, Subpart B

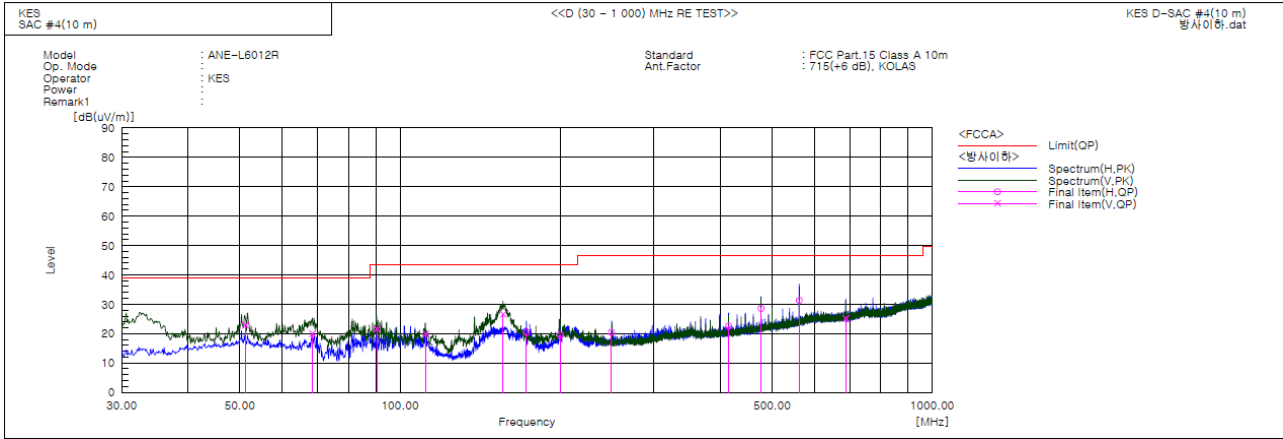

Final Result

No.	Frequency [MHz]	(P)	Reading QP [dB(uV)]	c.f [dB(1/m)]	Result QP [dB(uV/m)]	Limit QP [dB(uV/m)]	Margin QP [dB]	Height [cm]	Angle [deg]	Remark
1	51.216	V	43.9	-21.0	22.9	39.0	16.1	111.0	196.0	
2	68.484	V	44.3	-24.3	20.0	39.0	19.0	112.0	98.0	
3	90.529	V	45.6	-24.0	21.6	43.5	21.9	125.0	85.0	
4	111.861	V	42.3	-22.4	19.9	43.5	23.6	125.0	302.0	
5	156.162	V	51.5	-24.9	26.6	43.5	16.9	112.0	87.0	
6	172.731	H	44.5	-24.1	20.4	43.5	23.1	378.0	233.0	
7	200.012	H	40.5	-20.9	19.6	43.5	23.9	384.0	221.0	
8	249.549	H	39.8	-19.3	20.5	46.5	26.0	400.0	359.0	
9	414.264	H	36.5	-13.9	22.6	46.5	23.9	365.0	91.0	
10	476.651	H	40.8	-12.2	28.6	46.5	17.9	388.0	83.0	
11	562.241	H	41.1	-9.8	31.3	46.5	15.2	367.0	49.0	
12	687.986	V	32.9	-7.7	25.2	46.5	21.3	121.0	283.0	

This report shall not be reproduced except in full, without the written approval of KES Co., Ltd.
 The results shown in this test report refer only to the sample(s) tested unless otherwise stated.
 The authenticity of the test report, contact kes@kes.co.kr



KES Co., Ltd.

3701, 40, Simin-daero 365beon-gil,
 Dongan-gu, Anyang-si, Gyeonggi-do, 14057, Korea
 Tel: +82-31-425-6200 / Fax: +82-31-424-0450
 www.kes.co.kr

Report No.:
 KES-EM-22T0319-R1
 Page (19) of (31)

- IC Regulation ICES-003 Issue 7

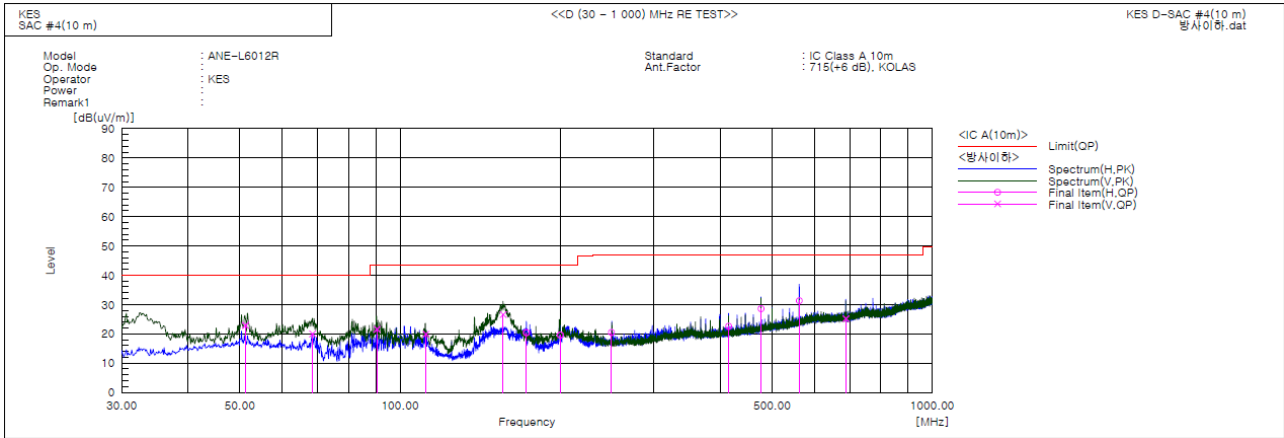

Final Result

No.	Frequency [MHz]	(P)	Reading QP [dB(uV)]	c.f [dB(1/m)]	Result QP [dB(uV/m)]	Limit QP [dB(uV/m)]	Margin QP [dB]	Height [cm]	Angle [deg]	Remark
1	51.216	V	43.9	-21.0	22.9	40.0	17.1	111.0	196.0	
2	68.484	V	44.3	-24.3	20.0	40.0	20.0	112.0	98.0	
3	90.529	V	45.6	-24.0	21.6	43.5	21.9	125.0	85.0	
4	111.861	V	42.3	-22.4	19.9	43.5	23.6	125.0	302.0	
5	156.162	V	51.5	-24.9	26.6	43.5	16.9	112.0	87.0	
6	172.731	H	44.5	-24.1	20.4	43.5	23.1	378.0	233.0	
7	200.012	H	40.5	-20.9	19.6	43.5	23.9	384.0	221.0	
8	249.549	H	39.8	-19.3	20.5	47.0	26.5	400.0	359.0	
9	414.264	H	36.5	-13.9	22.6	47.0	24.4	365.0	91.0	
10	476.651	H	40.8	-12.2	28.6	47.0	18.4	388.0	83.0	
11	562.241	H	41.1	-9.8	31.3	47.0	15.7	367.0	49.0	
12	687.986	V	32.9	-7.7	25.2	47.0	21.8	121.0	283.0	

◆ Calculation - SAC #4(10 m)

Result(QP) [dB(μV/m)] = (Reading(QP)[dB(μV)] + c.f[dB(1/m)])

Margin(QP)[dB] = Limit[dB(μV/m)] - Result(QP) [dB(μV/m)]

Reading(QP) : Reading value, Result(QP) : Reading value + Factor value

Limit(QP) : Limit value, c.f : (ANT Factor + Cable Loss - Preamp Factor), Margin: Margin value

This report shall not be reproduced except in full, without the written approval of KES Co., Ltd.
 The results shown in this test report refer only to the sample(s) tested unless otherwise stated.
 The authenticity of the test report, contact kes@kes.co.kr



Radiated Electric Field Emissions(Above 1 GHz)

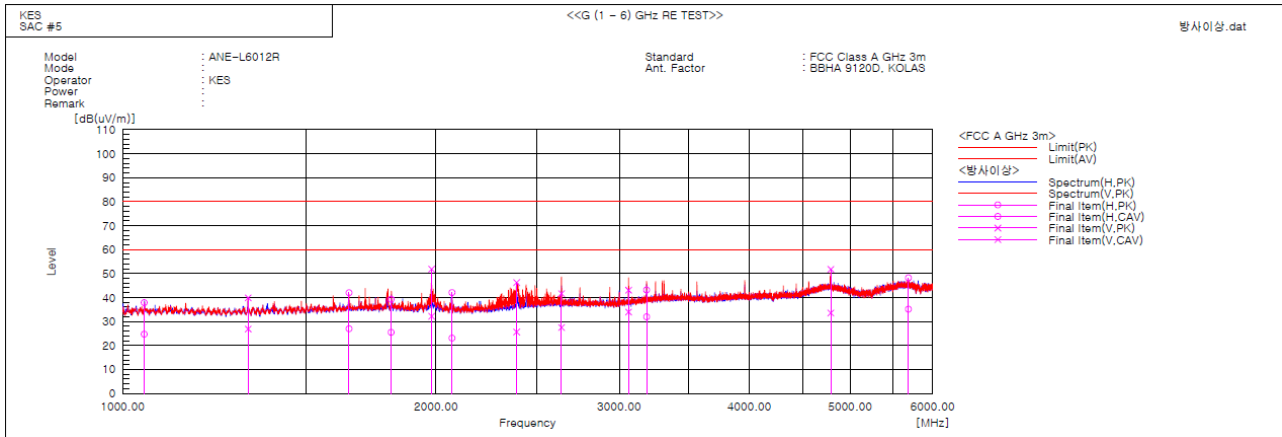

Final Result

No.	Frequency [MHz]	(P)	Reading PK [dB(uV)]	Reading CAV [dB(uV)]	c.f [dB(1/m)]	Result PK [dB(uV/m)]	Result CAV [dB(uV/m)]	Limit PK [dB(uV/m)]	Limit AV [dB(uV/m)]	Margin PK [dB]	Margin CAV [dB]	Height [cm]	Angle [deg]	Remark
1	1049.115	H	45.3	32.1	-7.4	37.9	24.7	80.0	60.0	42.1	35.3	400.0	55.8	
2	1320.026	V	45.7	32.7	-5.8	39.9	26.9	80.0	60.0	40.1	33.1	111.0	48.9	
3	1650.023	H	46.4	31.4	-4.4	42.0	27.0	80.0	60.0	38.0	33.0	386.0	356.2	
4	1811.003	H	42.9	29.1	-3.6	39.3	25.5	80.0	60.0	40.7	34.5	386.0	283.1	
5	1980.322	V	54.8	35.1	-2.9	51.9	32.2	80.0	60.0	28.1	27.8	103.0	4.3	
6	2072.542	H	44.8	25.8	-2.7	42.1	23.1	80.0	60.0	37.9	36.9	287.0	231.9	
7	2390.882	V	47.9	27.3	-1.6	46.3	25.7	80.0	60.0	33.7	34.3	124.0	199.1	
8	2640.112	V	42.1	27.9	-0.4	41.7	27.5	80.0	60.0	38.3	32.5	246.0	272.3	
9	3062.323	V	42.0	32.9	1.1	43.1	34.0	80.0	60.0	36.9	26.0	116.0	268.0	
10	3187.496	H	41.7	30.5	1.5	43.2	32.0	80.0	60.0	36.8	28.0	400.0	219.9	
11	4788.968	V	45.2	27.0	6.6	51.8	33.6	80.0	60.0	28.2	26.4	100.0	37.5	
12	5687.231	H	40.1	27.1	8.1	48.2	35.2	80.0	60.0	31.8	24.8	386.0	261.5	

◆ Calculation

$$\text{Result(PK/CAV)} [\text{dB}(\mu\text{V/m})] = (\text{Reading(PK/CAV)}[\text{dB}(\mu\text{V})] + \text{c.f}[\text{dB}(1/\text{m})])$$

$$\text{Margin(PK/CAV)}[\text{dB}] = \text{Limit}[\text{dB}(\mu\text{V/m})] - \text{Result(PK/CAV)} [\text{dB}(\mu\text{V/m})]$$

Reading(PK/CAV) : Reading value, Result(PK/CAV) : Reading value + Factor value

Limit(QP) : Limit value, c.f : (ANT Factor + Cable Loss - Preamp Factor), Margin: Margin value

This report shall not be reproduced except in full, without the written approval of KES Co., Ltd.
The results shown in this test report refer only to the sample(s) tested unless otherwise stated.
The authenticity of the test report, contact kes@kes.co.kr

Test Setup Photos and Configuration

Conducted Emissions at Mains Power Ports



This report shall not be reproduced except in full, without the written approval of KES Co., Ltd.
The results shown in this test report refer only to the sample(s) tested unless otherwise stated.
The authenticity of the test report, contact kes@kes.co.kr

Radiated Electric Field Emissions(Below 1 GHz)

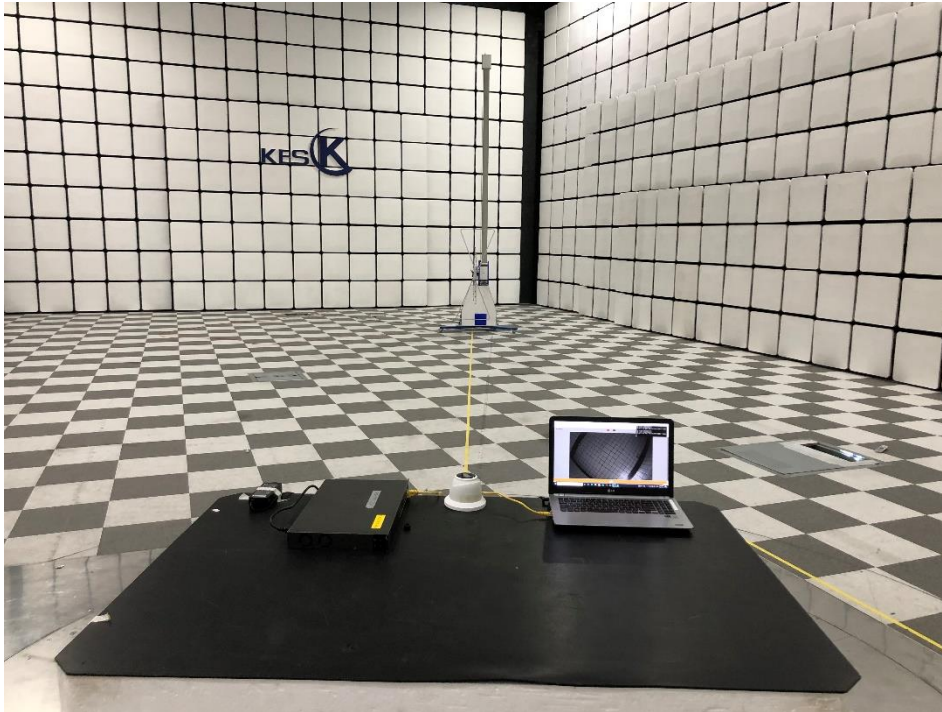

This report shall not be reproduced except in full, without the written approval of KES Co., Ltd.
The results shown in this test report refer only to the sample(s) tested unless otherwise stated.
The authenticity of the test report, contact kes@kes.co.kr

Radiated Electric Field Emissions(Above 1 GHz)

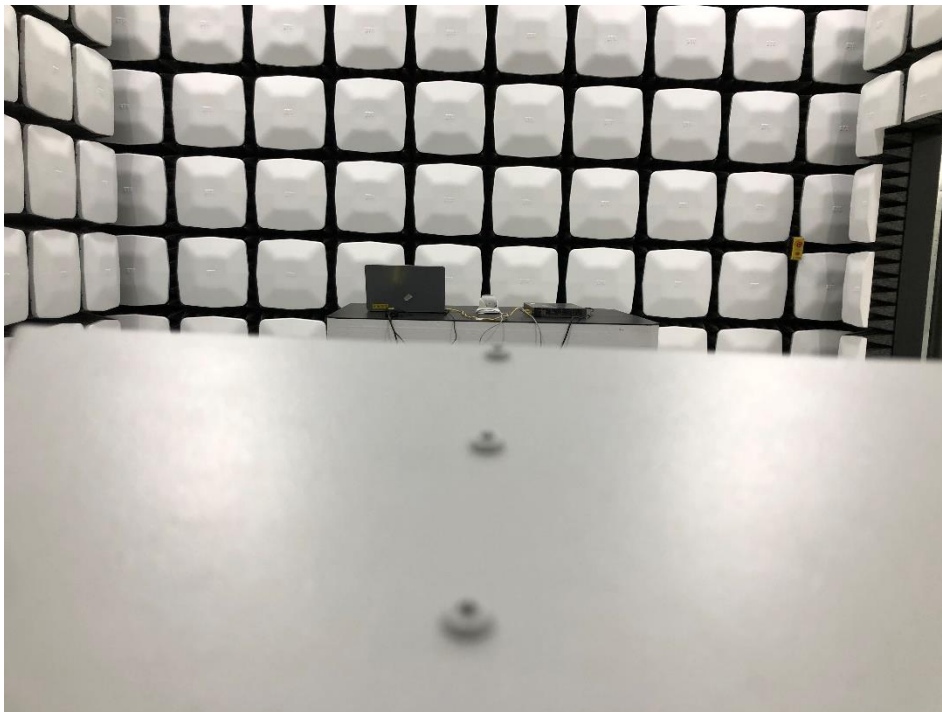
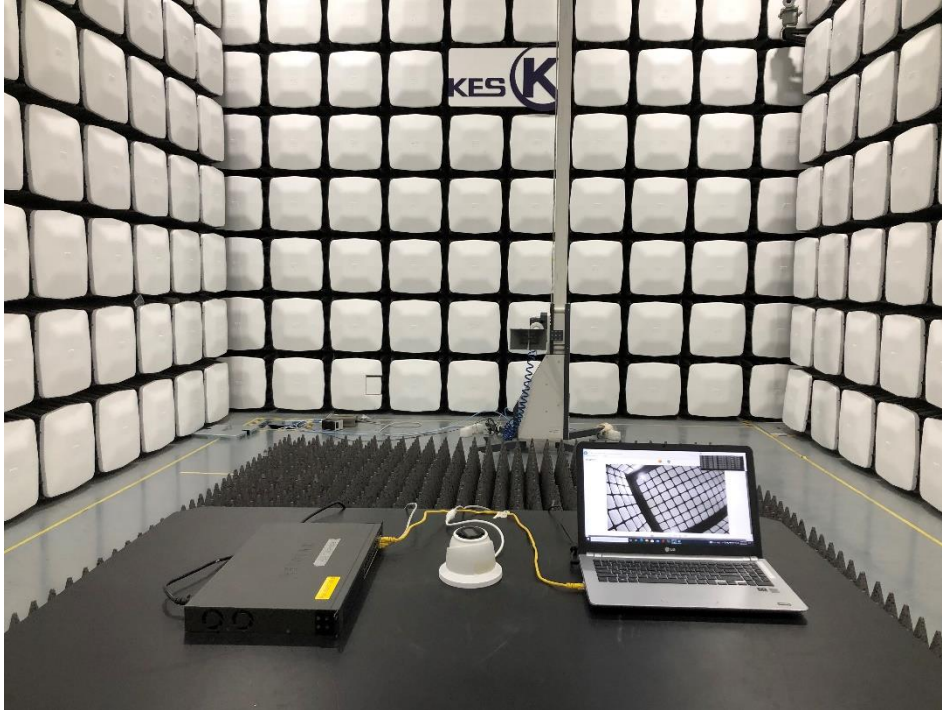

This report shall not be reproduced except in full, without the written approval of KES Co., Ltd.
The results shown in this test report refer only to the sample(s) tested unless otherwise stated.
The authenticity of the test report, contact kes@kes.co.kr

EUT External Photographs

(Top)



(Bottom)



This report shall not be reproduced except in full, without the written approval of KES Co., Ltd.
The results shown in this test report refer only to the sample(s) tested unless otherwise stated.
The authenticity of the test report, contact kes@kes.co.kr

EUT Internal Photographs

(Internal View)



This report shall not be reproduced except in full, without the written approval of KES Co., Ltd.
The results shown in this test report refer only to the sample(s) tested unless otherwise stated.
The authenticity of the test report, contact kes@kes.co.kr

EUT Internal View – Board 1

(Top)

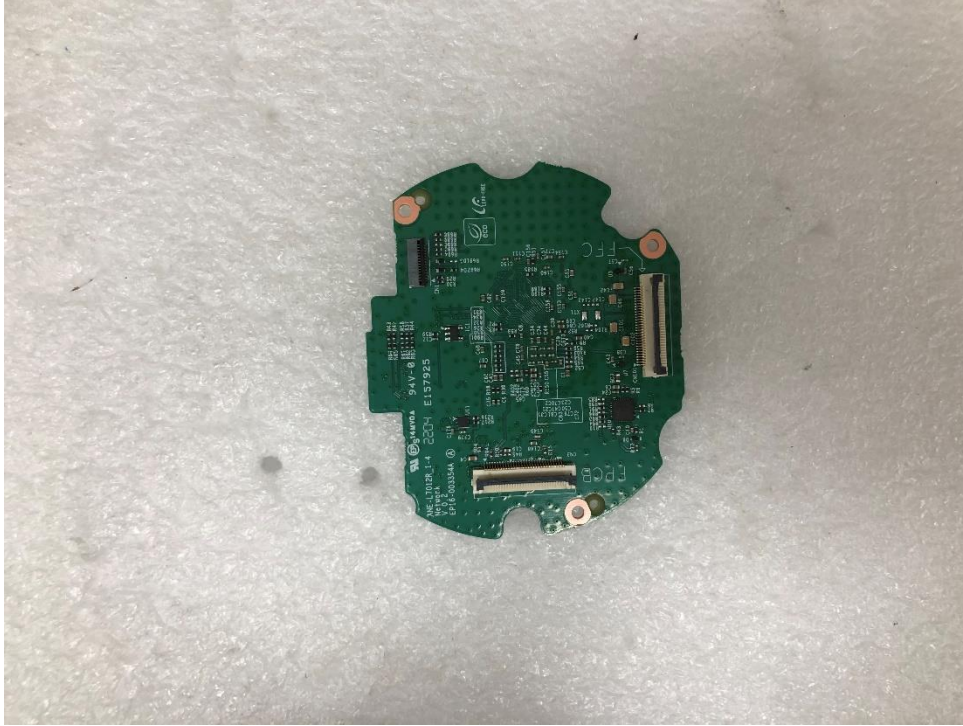

(Bottom)

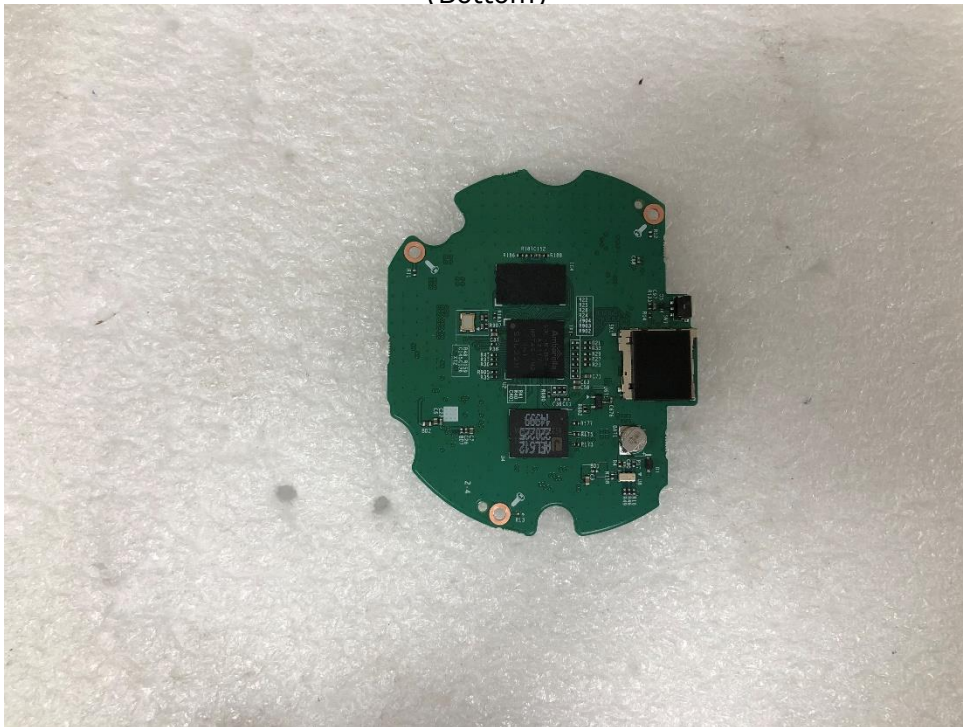

This report shall not be reproduced except in full, without the written approval of KES Co., Ltd.
The results shown in this test report refer only to the sample(s) tested unless otherwise stated.
The authenticity of the test report, contact kes@kes.co.kr

EUT Internal View – Board 2

(Top)

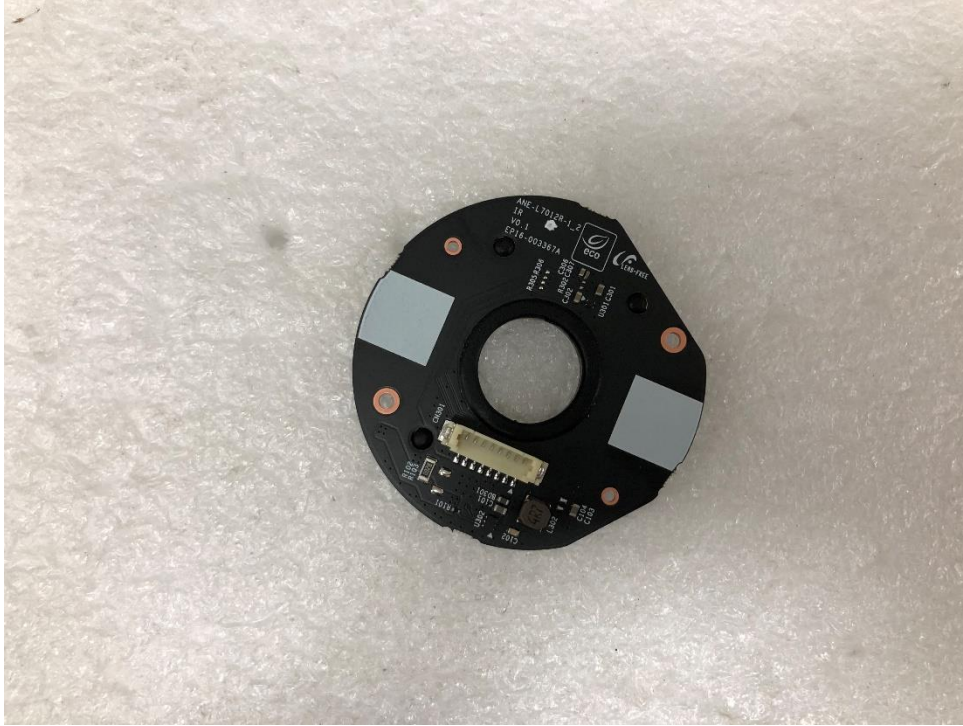

(Bottom)



This report shall not be reproduced except in full, without the written approval of KES Co., Ltd.
The results shown in this test report refer only to the sample(s) tested unless otherwise stated.
The authenticity of the test report, contact kes@kes.co.kr

EUT Internal View – Board 3

(Top)

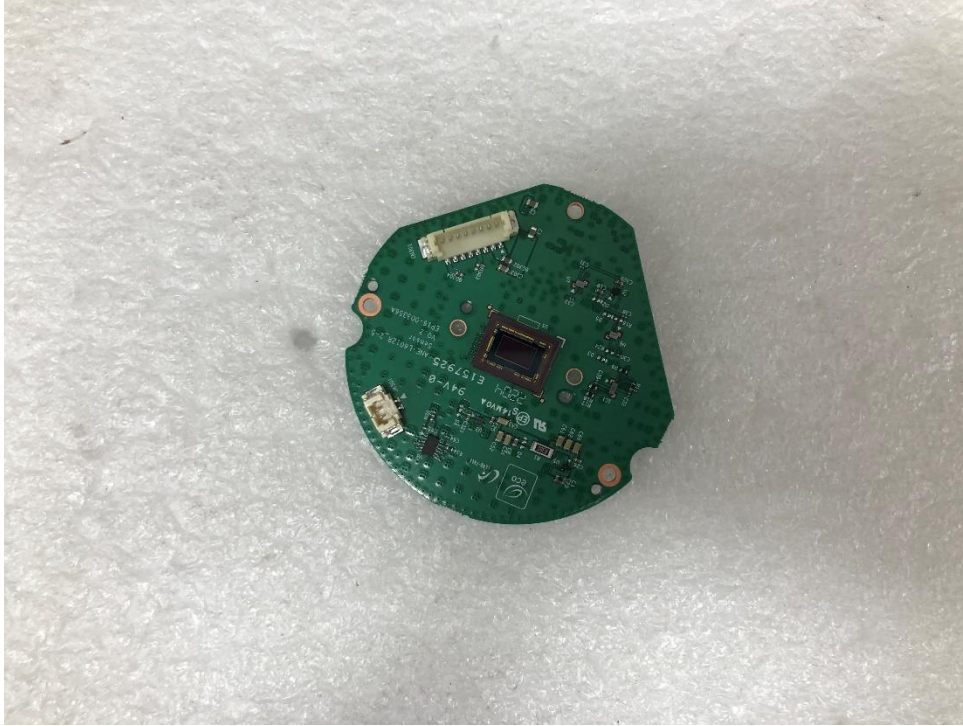

(Bottom)

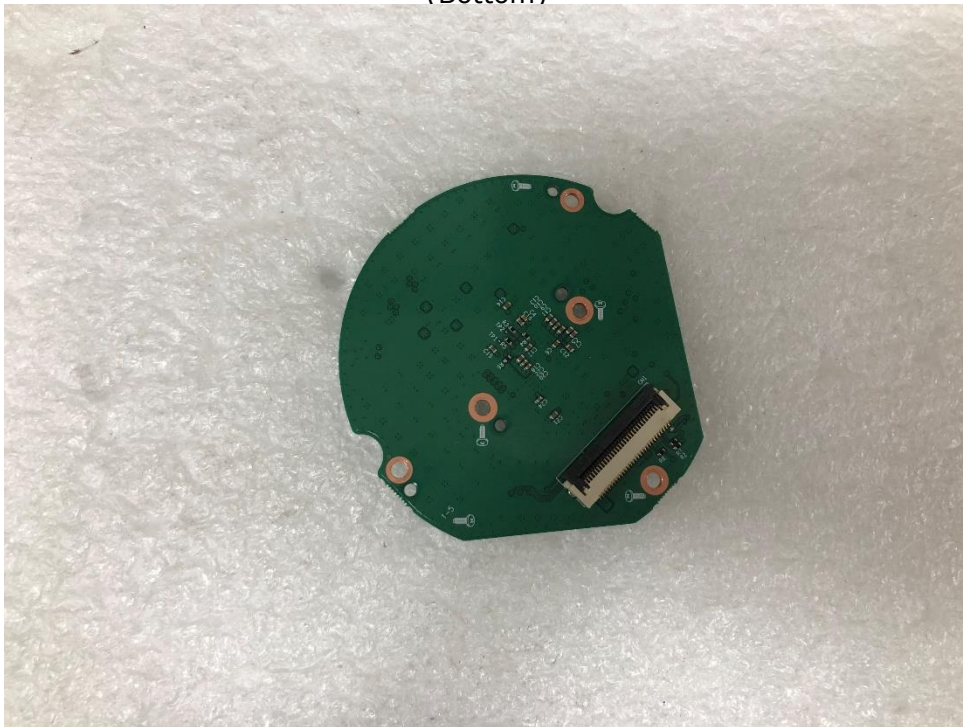

This report shall not be reproduced except in full, without the written approval of KES Co., Ltd.
The results shown in this test report refer only to the sample(s) tested unless otherwise stated.
The authenticity of the test report, contact kes@kes.co.kr

EUT Internal View – Board 4

(Top)



(Bottom)



This report shall not be reproduced except in full, without the written approval of KES Co., Ltd.
The results shown in this test report refer only to the sample(s) tested unless otherwise stated.
The authenticity of the test report, contact kes@kes.co.kr

EUT Internal View – Lens

(Top)

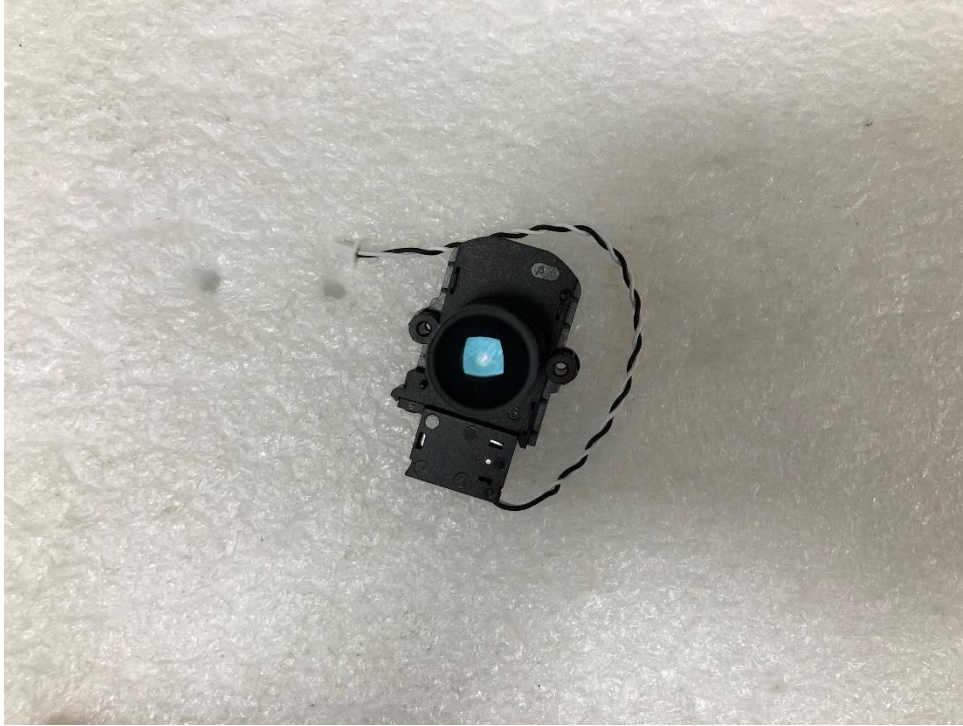

(Bottom)



This report shall not be reproduced except in full, without the written approval of KES Co., Ltd.
The results shown in this test report refer only to the sample(s) tested unless otherwise stated.
The authenticity of the test report, contact kes@kes.co.kr

Label Photographs

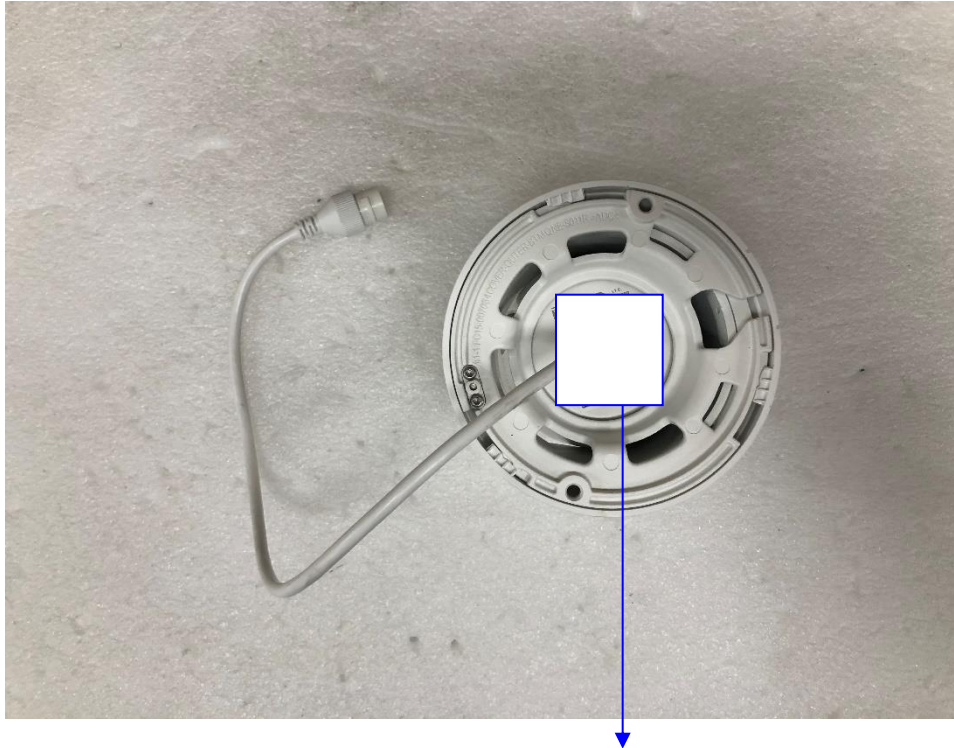

CAN ICES-3(A) / NMB-3(A)

This device complies with part 15 of the FCC Rules. Operation is subject to the following two conditions: (1) This device may not cause harmful interference, and (2) this device must accept any interference received, including interference that may cause undesired operation

This device complies with Industry Canada license-exempt RSS standard(s). Operation is subject to the following two conditions: (1) this device may not cause interference, and (2) this device must accept any interference, including interference that may cause undesired operation of the device.

Le présent appareil est conforme aux CNR d'Industrie Canada applicables aux appareils radio exempts de licence. L'exploitation est autorisée aux deux conditions suivantes :
(1) l'appareil ne doit pas produire de brouillage, et (2) l'utilisateur de l'appareil doit accepter tout brouillage radioélectrique subi, même si le brouillage est susceptible d'en compromettre le fonctionnement.