

Quick Start Guide

ProMA Series

Version: 1.1

1 Product Overview

ProMA-QR

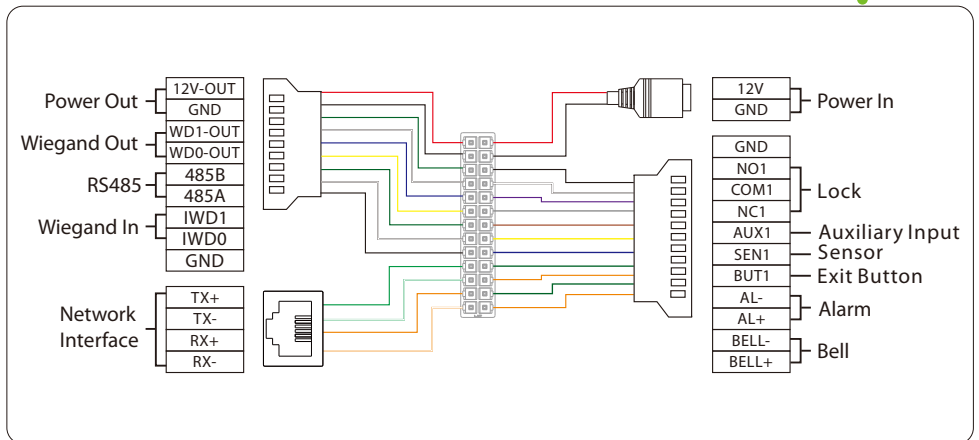
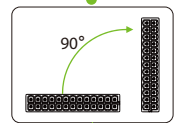
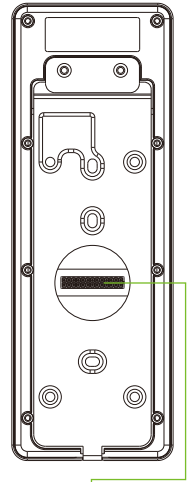
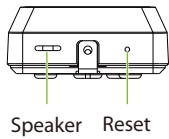
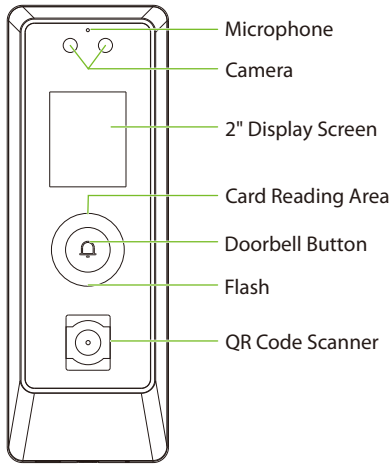

Note: ProMA-QR has an additional QR code recognition function than ProMA-RF, ProMA has an additional fingerprint recognition function than ProMA-RF, and the rest are the same.

ProMA

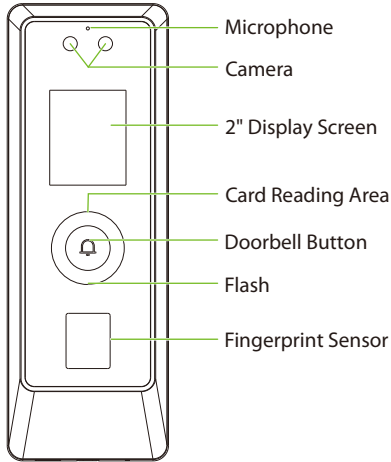

ProMA-RF

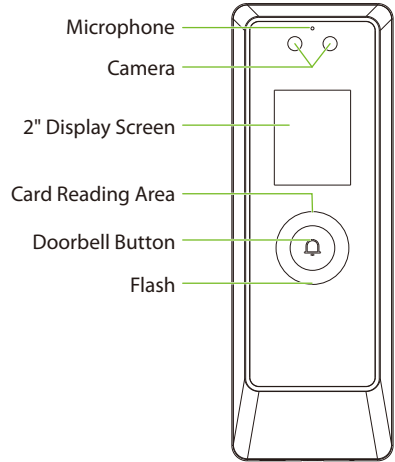

2 Installation Environment

Please refer to the following recommendations for installation.



INSTALL INDOORS ONLY

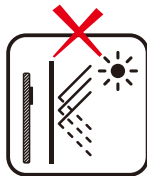

AVOID INSTALLATION NEAR GLASS WINDOWS

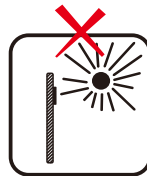

AVOID DIRECT SUNLIGHT AND EXPOSURE

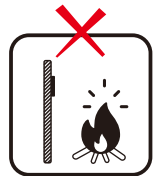

AVOID USE OF ANY HEAT SOURCE NEAR THE DEVICE

3 Device Installation

ProMA series installation are the same, the following is an example of ProMA.

- ① Attach the mounting template sticker to the wall, and drill holes according to the mounting paper.
- ② Fix the backplate on the wall using wall mounting screws.
- ③ Attach the device to the backplate.
- ④ Fasten the device to the backplate with a security screw.

1

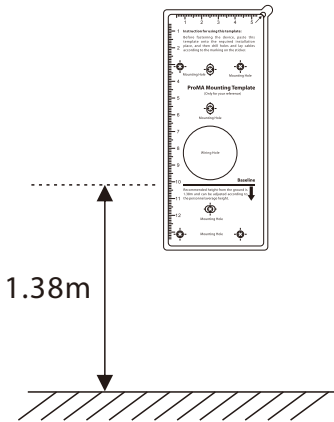

2

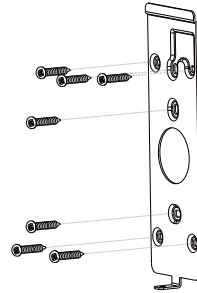

3

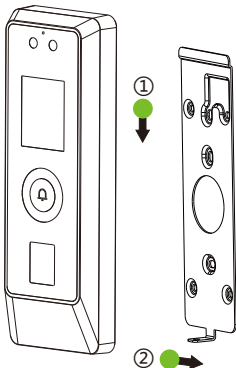

4

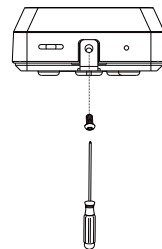

4 Standalone Installation

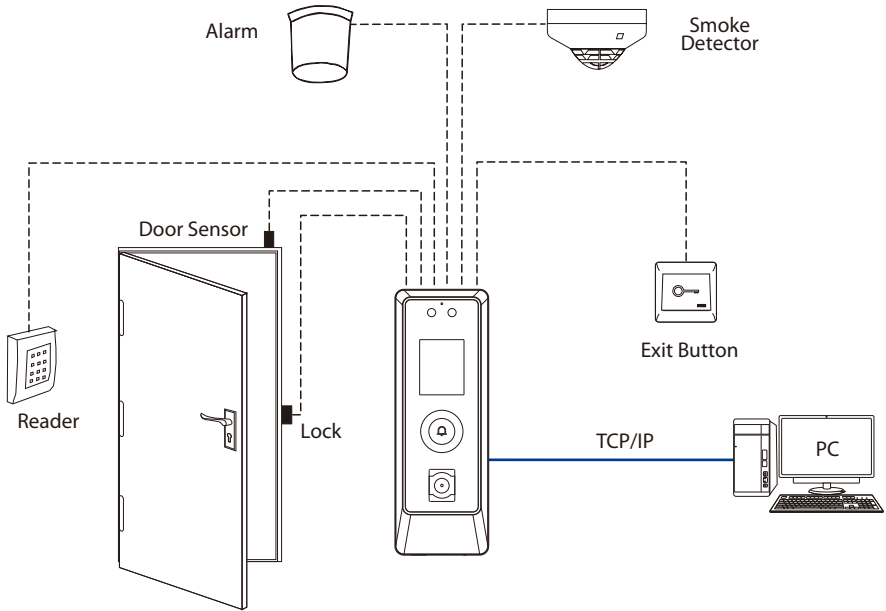

5 Power Connection

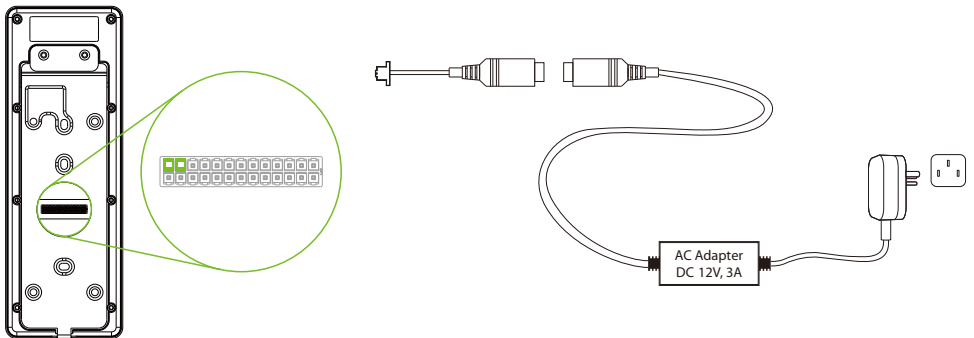

Recommended power supply

- Rating of 12V and 3A
- To share the device's power supply with other devices, use a power supply with higher current ratings.

6 Lock Relay Connection

The system supports both **Normally Opened Lock** and **Normally Closed Lock**. The **NO Lock** (normally opened when powered) is connected with '**NO**' and '**COM**' terminals, and the **NC Lock** (normally closed when powered) is connected with '**NC**' and '**COM**' terminals. The power can be shared with the lock or can be used separately for the lock, as shown in the example with **NC Lock** below:

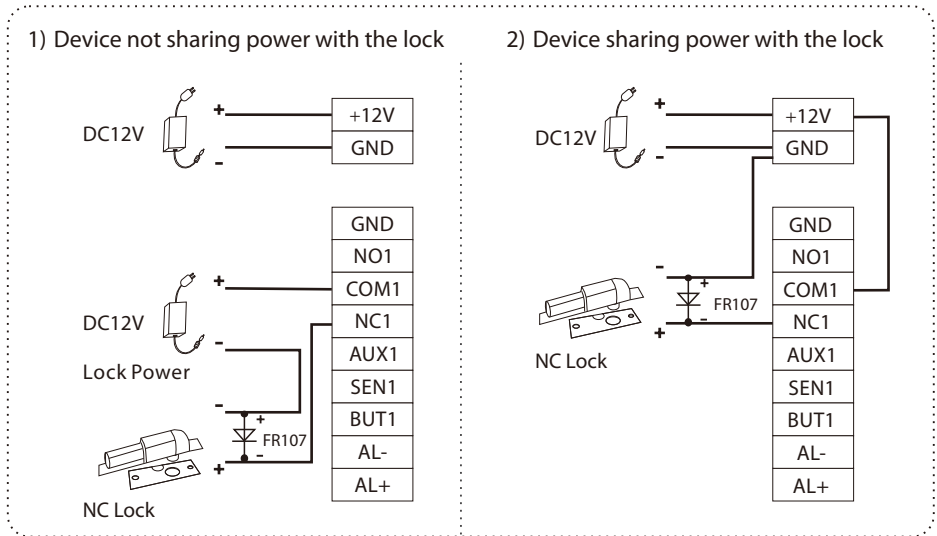

7 Door Sensor, Exit Button, Alarm and Auxiliary Connection

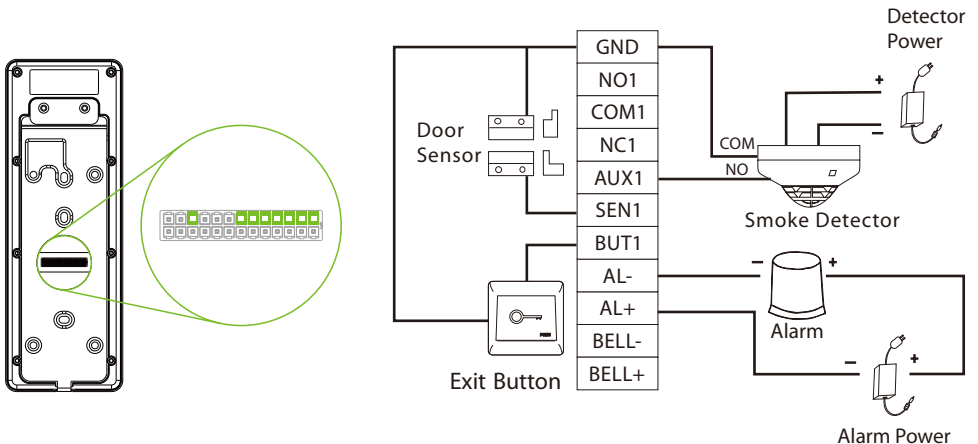

8 Wiegand Connection

Wiegand card reader connects to the top 4 pins of the wiegand terminal and the last two pins are used by the Access Controller, as shown in the following figure. It sends the credentials to the device via wiegand communication.

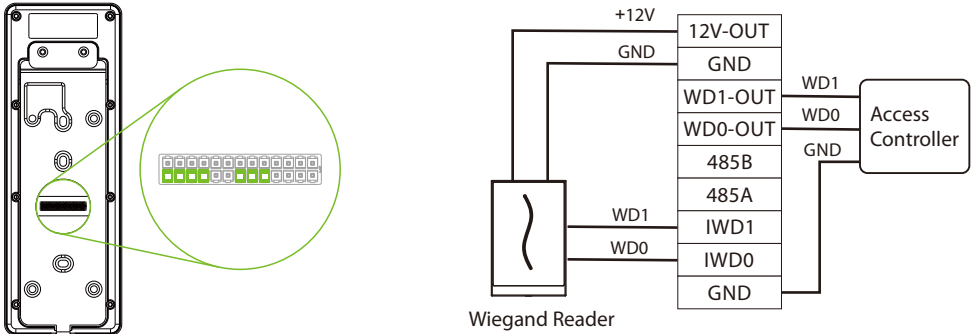

9 RS485 Connection

The RS485 lets user connect to multiple readers to the device. RS485 can be connected to the terminal, as shown in the figure below.

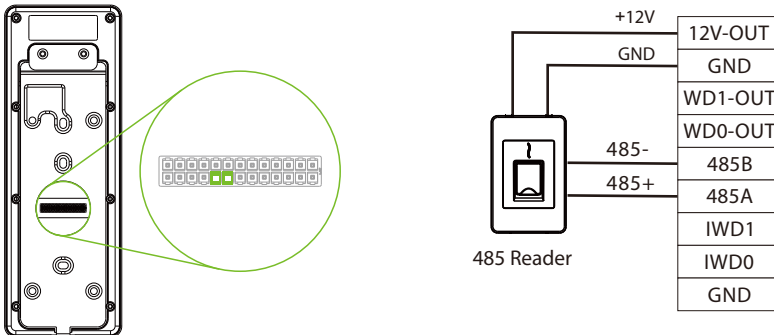

10 Ethernet Connection

Connect the device and computer software over an Ethernet cable. An example is shown below:



Default IP address: 192.168.1.201
Subnet mask: 255.255.255.0

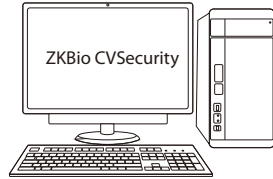

IP address: 192.168.1.130
Subnet mask: 255.255.255.0

Note: In LAN, IP addresses of the server (PC) and the device must be in the same network segment when connecting to ZKBio CVSecurity software.

11 Login WebServer

All operations such as device information, communication settings, user management and system settings are operated and set up on WebServer.

1. Press and hold the Doorbell button of the device until the IP pops up.

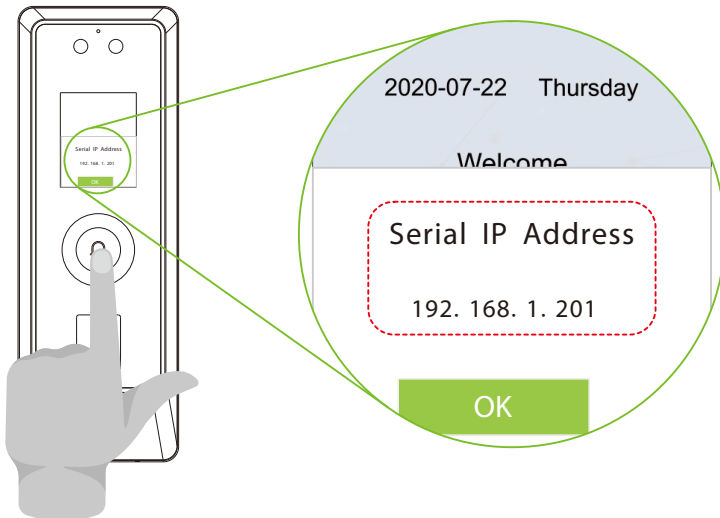

- Open a browser to enter the address to log in the WebServer, the address is the [https:// Serial IP Address:1443](https://Serial IP Address:1443), for example: <https://192.168.1.201:1443>.

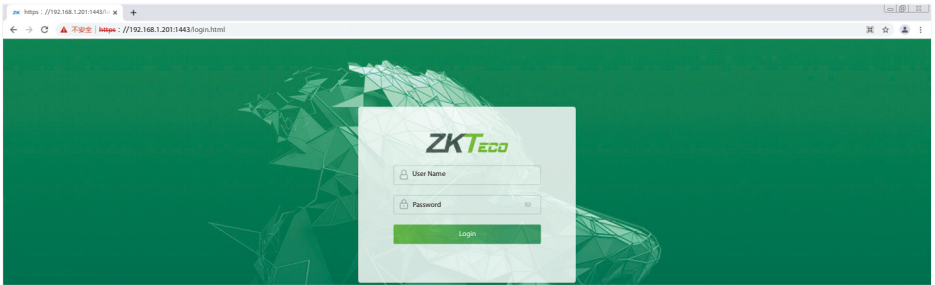
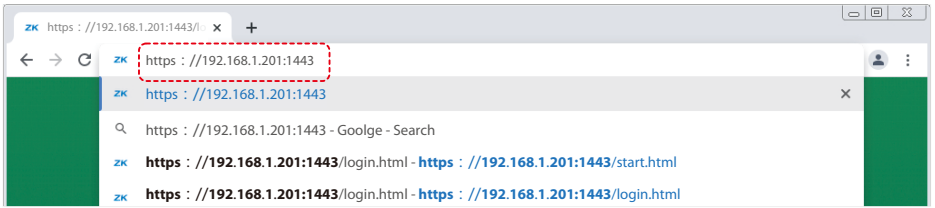

- Enter the account ID and password, the default account ID is: **admin**, password: **admin@123**.

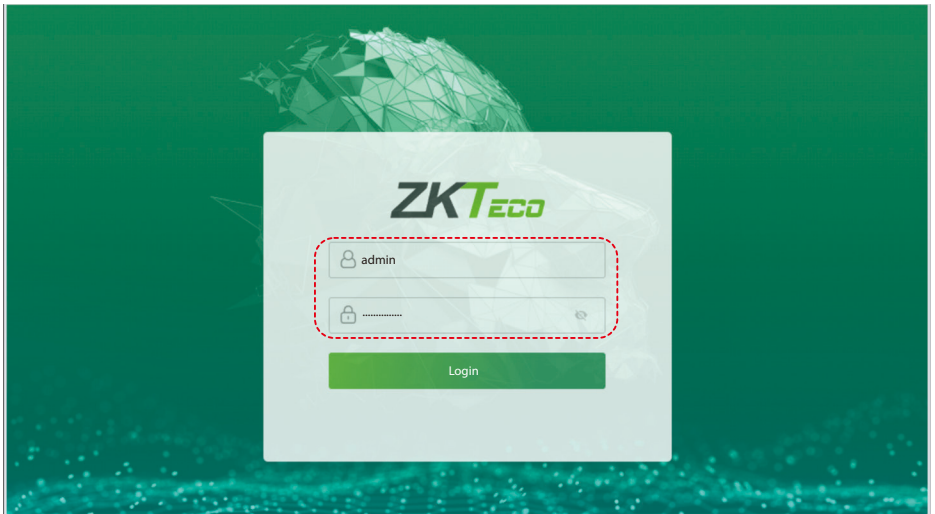

Note:

- After logging in for the first time, users need to reset their original password and log in again before they can use it.
- In order to retrieve the password easily, please register a super admin first.

12 User Registration

Click on **[All Users]** on the WebServer to register a new user. Settings include entering user ID, name, password, card number, fingerprint, face, setting user role and access control role.

The screenshot shows the ZKTeco WebServer interface. On the left is a dark sidebar menu with the following items: System Info, Device Info, Device Capacity, Firmware Info, User Mgt. (highlighted in green), Advanced Setti (with a 'Step 1' callout), COMM., Cloud Service Setup, Date Setup, System, Serial Comm, Face, Autotest, Wiegand Setup, Device Management, Device Management, Update Firmware, Change Password, Operation Log, and Download Firmware Logs. The main content area is titled 'Basic Info' and contains a registration form with fields for User ID (1), Name (Mike), Rights (Normal User), Password (masked with dots), Card Number, and Access Control Role (1). Below the form are 'Confirm' and 'Back' buttons. A red dashed box encloses the form fields, with a 'Step 2' callout pointing to it and the text 'Enter the User Info.'. Below the 'Basic Info' section is the 'Online Registration' section, which has three 'Register' buttons for Fingerprint, Face, and Card Number. A red dashed box encloses these buttons, with a 'Step 4' callout pointing to it and the text 'Enroll Fingerprint, Face and Card.'. The ZKTeco logo and a power icon are at the top of the page.

Click **[Register]** to complete the registration of fingerprint, face and card number.

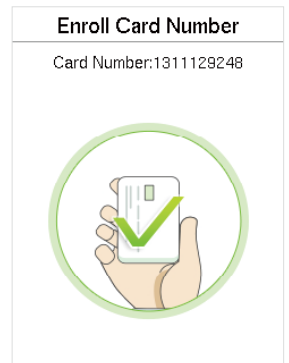
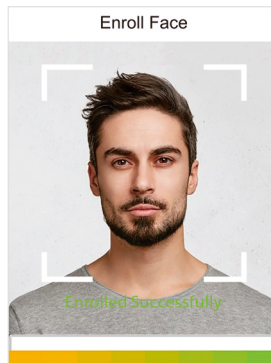

13 Connection to ZKBio CVSecurity Software

1. Set the IP address and cloud service server address in the [Advanced Settings] option on the WebServer.

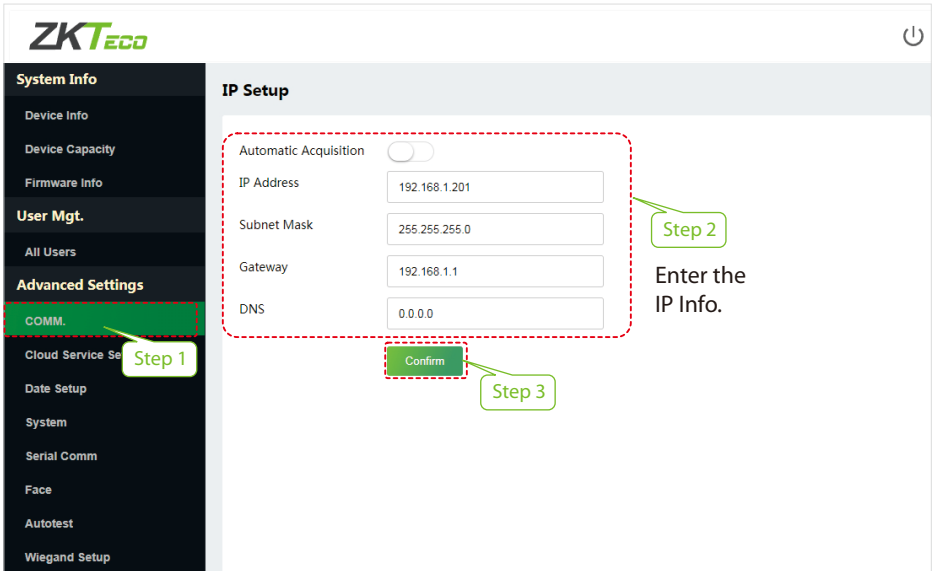

The screenshot shows the ZKTeco WebServer interface. On the left is a navigation menu with categories: System Info, User Mgt., and Advanced Settings. Under Advanced Settings, 'COMM.' is highlighted with a green box and labeled 'Step 1'. The main content area is titled 'IP Setup' and contains the following fields: 'Automatic Acquisition' (toggle), 'IP Address' (192.168.1.201), 'Subnet Mask' (255.255.255.0), 'Gateway' (192.168.1.1), and 'DNS' (0.0.0.0). A red dashed box encloses these fields, with a callout 'Step 2' pointing to it and the text 'Enter the IP Info.' below. A 'Confirm' button is at the bottom, with a callout 'Step 3' pointing to it.

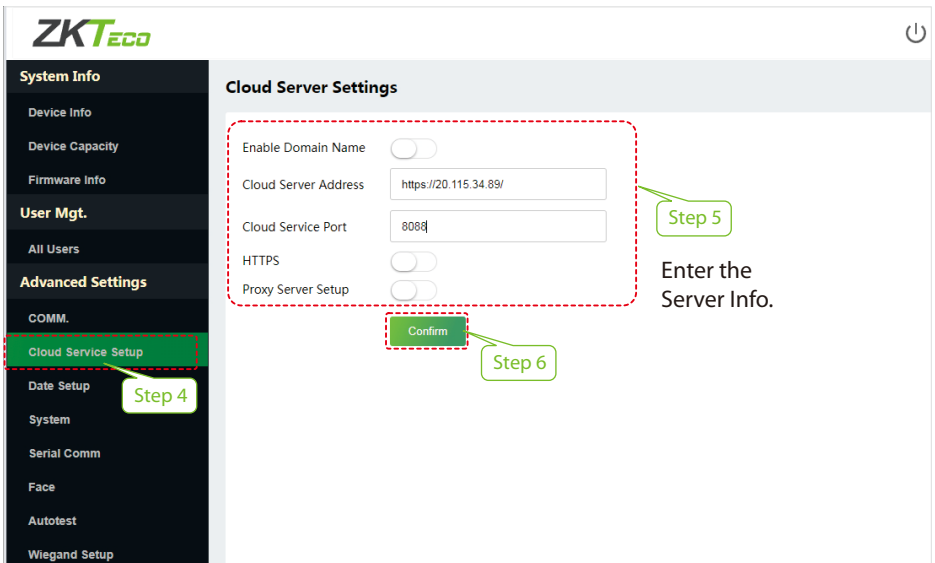

The screenshot shows the ZKTeco WebServer interface. On the left is a navigation menu with categories: System Info, User Mgt., and Advanced Settings. Under Advanced Settings, 'Cloud Service Setup' is highlighted with a green box and labeled 'Step 4'. The main content area is titled 'Cloud Server Settings' and contains the following fields: 'Enable Domain Name' (toggle), 'Cloud Server Address' (https://20.115.34.89/), 'Cloud Service Port' (8088), 'HTTPS' (toggle), and 'Proxy Server Setup' (toggle). A red dashed box encloses these fields, with a callout 'Step 5' pointing to it and the text 'Enter the Server Info.' below. A 'Confirm' button is at the bottom, with a callout 'Step 6' pointing to it.

- Click **[Access]** > **[Access Device]** > **[Device]** > **[Search Device]** to search the device on the software. When an appropriate server address and port is set on the device, the searched devices are displayed automatically.

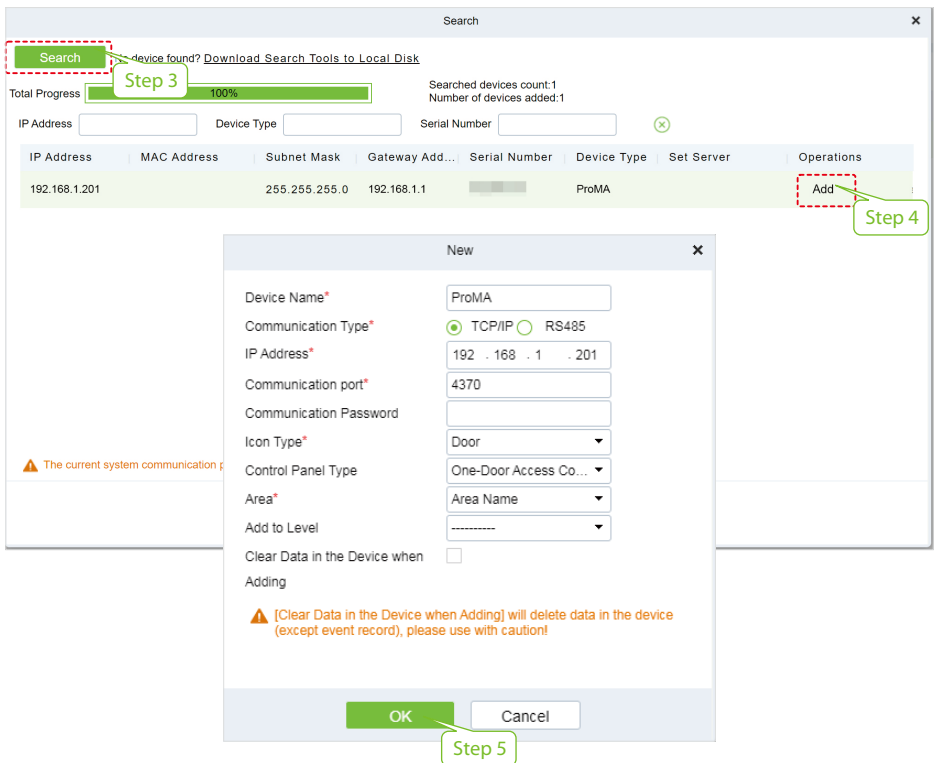
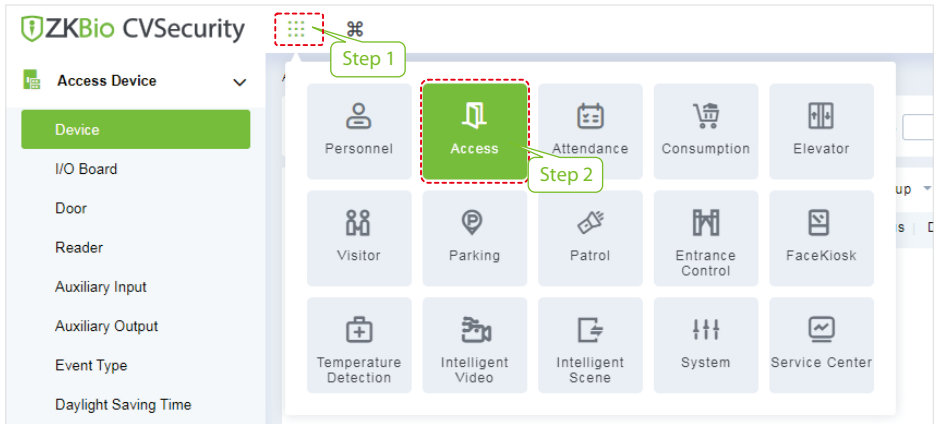

For more details, please refer to the *ZKBio CVSecurity V6600 User Manual*.

14 QR Verification★

1. In **[System] > [Basic Management] > [Parameters]** of ZKBio CVSecurity software, set **Enable QR Code** to “Yes”, and select the QR code status according to the actual situation.
2. On the Server, choose **[System] > [Authority Management] > [Client Register]** to add a registered App client.
3. Open the APP, enter the IP address or domain name of the server, and its port number, scan the QR Code of the new APP client. After the connection is successful, tap on Employee Login screen. Enter the Employee ID and Password (Default: 123456) to login.
4. Tap **[Mobile Credential]** on the APP, and a QR code will appear, parallel the phone screen to the device QR code scanner. For details, please refer to *ProMA Series User Manual*.

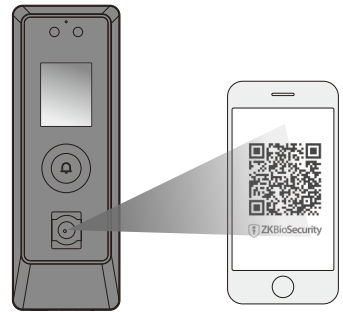
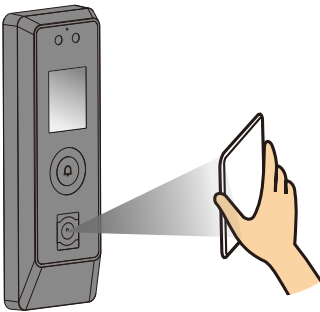
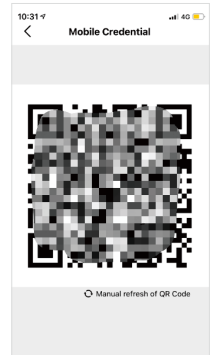
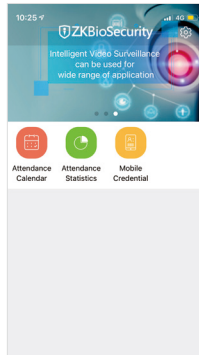
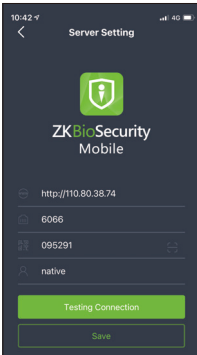

Note:

1. Place your phone within the range of **15 to 50 (cm)** from the device (distance depends on the size of the phone screen), and do not block the device QR code scanner and QR code in the phone screen.
2. This feature is only available for ProMA-QR.

www.zkteco.eu