

# **Operation Manual for M7 Series Embedded Hard Disk Video Recorder**

# Preface

Thank you for purchasing our products. For any questions or needs, please feel free to contact us.

## Applicable Models

This manual is applicable to the following models:

Product Series	Model	Product Name
TC-R3-IBP(H) series	TC-R3105 configuration: I/B/P  TC-R32(10/20) configuration: I/B/P  TC-R3220 configuration: I/B/P/H	H.265 PSE series  NVR
TC-R1-IB(N) series	TC-  R11(05/10/20)configuration:  I/B/V2.0	Standard series  NVR

	<p>TC-R1230 configuration: I/B</p> <p>TC-R12(10/20) configuration: I/B</p> <p>TC-R14(20/40)configuration: I/B/N</p>	
TC-R5-IBN series	<p>TC-R5110 configuration: I/B/N</p> <p>TC-R5220 configuration: I/B/N</p> <p>TC-R54(20/40)configuration: I/B/N</p> <p>TC- R58(20/40/80)configuration: I/B/N</p> <p>TC-R516(40/80/160) configuration: E/B/N</p>	<p>Standard series</p> <p>NVR</p>
TC-R3- (I/E)BNZ series	<p>TC-R3230 configuration: I/B</p> <p>TC- R31(05/10/20)configuration: I/B(/Z)</p>	<p>Standard series</p> <p>NVR</p>

	<p>TC-R32(10/20)configuration: I/B(/Z)</p> <p>TC-R3440 configuration: I/B/N(/Z)</p> <p>TC-R38(40/80)configuration: I/B/N(/Z)</p> <p>TC-R31680configuration: E/B/N(/Z)</p>	
TC-R5-IF(N) series	<p>TC- R58(20/40/80)configuration: I/F</p> <p>TC-R5105configuration: I/F</p> <p>TC-R5210configuration: I/F</p>	Face recognition NVR
TC-R3-IF(N/Z) series	<p>TC- R38(20/40/80)configuration: I/F/N(/Z)</p> <p>TC-R3105configuration: I/F(/Z)</p> <p>TC-R3210configuration: I/F(/Z)</p>	Face recognition NVR

TC-R1120	TC-R1120 I/B/V2.0	configuration:	Multi-media NVR
----------	----------------------	----------------	-----------------

## Disclaimer

- This manual may contain technical inaccuracies, or inconsistencies with product functions and operations, or misprint. The company will keep the contents contained in this Manual up-to-date in accordance with product enhancements and will periodically improve or update the software and hardware products described in this Manual. The updated contents will be reflected in the latest version of this Manual without prior notice.
- New technologies are continuously used in the company. Our products are subject to improvement without prior notice.
- The contents contained in this Manual are for reference and guidance only for users and not guaranteed to be exactly the same with the real product. The real product shall prevail.
- The parts, components and accessories mentioned in this Manual do not represent the standard configurations of the equipment. For detailed configurations, the packing list shall prevail.



- All words, tables and figures in this Manual are protected by relevant national regulations and laws and shall not be used without permission.

## About Default 1

- Default administrator account: admin
- Default IP address: 192.168.1.3

## Symbols

The symbols that appear in this document are explained as follows:

<b>Symbol</b>	<b>Description</b>
	Indicates a moderate or low potential danger that, if not avoided, may result in minor or moderate personal injury.
	Indicates a potential risk that, if not avoided, may result in device damage, data loss, degraded device performance, or unpredictable results.
	Indicates additional information of the text body as the emphasis and supplement.

## Table of Contents

<b>Operation Manual for M7 Series Embedded Hard Disk Video Recorder.....</b>	<b>1</b>
<b>1. Overview of Product Functions .....</b>	<b>15</b>
<b>2. Need-to-Know .....</b>	<b>22</b>
<b>2.1 Introduction to Front panel.....</b>	<b>22</b>
2.2 Introduction to Rear Panel.....	27
<b>2.3 Instructions to Mouse Operations .....</b>	<b>33</b>
<b>3. Installation and Connection.....</b>	<b>35</b>
<b>3.1 Precautions for Installation .....</b>	<b>35</b>
3.2. Installing HDD.....	37
<b>3.2.1 Calculation Method of HDD Capacity .....</b>	<b>38</b>
<b>3.2.2 HDD Installation Procedure .....</b>	<b>39</b>
<b>4. Local Configuration and Operation .....</b>	<b>42</b>
<b>4.1 Switch ON/OFF .....</b>	<b>42</b>
<b>4.4.1 Switch ON .....</b>	<b>42</b>
<b>4.1.2. Switch OFF .....</b>	<b>43</b>
<b>4.2 Equipment Activation .....</b>	<b>44</b>

4.3 Boot Wizard.....	46
4.4 Cameras.....	52
<b>4.4.1 Adding Channels from the Shortcut Bar</b> .....	52
<b>4.4.2 Adding Digital Channels Using Regular Methods</b> .....	55
<b>4.4.3 Adding POE Camera</b> .....	61
<b>4.4.4 Quick Add</b> .....	62
<b>4.4.5 Configuration Management</b> .....	62
<b>4.4.6 IPC Central Management</b> .....	64
<b>4.4.7 POE Power Information</b> .....	71
<b>4.4.8 Code Setting</b> .....	72
<b>4.4.9 Video Setting</b> .....	77
<b>4.4.10. OSD</b> .....	85
<b>4.4.11 Motion</b> .....	88
<b>4.4.12. Mask Alarm</b> .....	89
<b>4.4.13 Alarm Input</b> .....	90
<b>4.4.14 Video Loss</b> .....	92



<b>4.4.15 PTZ Setting</b> .....	93
<b>4.4.16. Three Smarts Setting</b> .....	94
<b>4.5 Preview</b> .....	97
<b>4.5.1 Interface Status</b> .....	97
<b>4.5.2 Task Bar Menu</b> .....	97
<b>4.5.3 Shortcut Preview</b> .....	103
<b>4.5.4 Preview Parameter Setting</b> .....	107
<b>4.5.5 Preview Interface Message</b> .....	111
<b>4.5.6 Audio Preview and Intercom</b> .....	114
<b>4.5.7 Right Back to Preview Interface</b> .....	114
<b>4.6 PTZ control</b> .....	114
<b>4.6.1 PTZ Parameter Setting</b> .....	114
<b>4.6.2 PTZ Control</b> .....	115
<b>4.6.3 Preset Position, Cruise, Trajectory Settings and Recalling</b> ...	117
<b>4.6.4 USB Keyboard Controlled PTZ</b> .....	121
<b>4.7 Storage Setting</b> .....	122

4.7.1 Recording.....	122
4.7.2 Parameter .....	129
4.7.3 Diskgroup Allocation.....	129
4.7.4. Images Setting.....	134
4.7.5. Reindex.....	136
4.8 Playback.....	137
4.8.1 Instant Playback.....	137
4.8.2 Description of Playback Interface.....	137
4.8.3 Normal Playback .....	140
4.8.4 Event Playback.....	141
4.8.5. Tag Playback.....	142
4.8.6 Smart Search Playback.....	145
4.8.7 Video Concernt Playback.....	149
4.8.8 Time-phased Playback .....	151
4.8.9. Picture Playback.....	152
4.8.10 External File Playback .....	153

<b>4.8.11. Log Management</b> .....	155
<b>4.8.12. Playback Assist Function</b> .....	156
4.9 Backup .....	160
4.10. System Maintenance .....	166
4.10.1 Information .....	166
4.10.2 Log Management.....	172
4.10.3 Configuration .....	174
4.10.4 Reset To Default.....	175
4.10.5 Automatic Maintenance.....	176
4.10.6. System Upgrade .....	177
4.10.7 Network Detect .....	180
4.10.8. Disk Detection.....	182
4.11. System Setting .....	185
4.11.1 General Setting .....	185
4.11.2 Network Setting .....	188
4.11.3 Disk Management.....	199

4.11.4 Array Management.....	203
4.11.5 Hot-spare Setting.....	209
4.11.6 Error Management.....	213
4.11.7 User Management .....	214
4.11.8 Other Setting.....	225
4.12 Alarm Setting.....	227
4.12.1 Alarm Input.....	227
4.12.2 Alarm Output .....	229
4.12.3 Alarm Host.....	231
4.12.4 Manual Alarm.....	234
4.12.5 Clear Alarm .....	234
4.13. Alert Management.....	235
4.13.1 Early-warning Configuration.....	235
4.13.2 Local Configuration of Early-warning Configuration .....	241
4.13.3 Early-warning Search .....	242
4.14. VCA.....	243

4.14.1 Smart Config .....	243
4.14.2 Event Parameters .....	244
4.14.3 Alarm Setting .....	246
4.14.4 VCA Report .....	248
4.14.5 Management of face library.....	251
4.14.6 Face Detection .....	256
4.14.7 Face Configuration .....	259
4.14.8 Face Retrieval .....	261
4.14.9 Face Statistics .....	264
4.14.10 Alarm Infomation.....	267
4.15. Mobile Monitoring.....	267
5. Internet Keyboard .....	268
5.1 Keyboard Installation.....	268
5.2 Description of Keys .....	269
A LCD Display: .....	269
B Main Key Area:.....	269

C DVR Control Key Area: .....	271
D Extended Function Key Area: .....	272
E Camera Control Key Area:.....	273
F Control Device Type Selection and Matrix Override Control Key Area: .....	274
G 3D Vector Shift Rocker.....	274
Appendix 1 Reference for HDD Capacity Calculation .....	275
Appendix 2 Troubleshooting of Common Faults .....	276
Appendix 3 Maintenance Instructions.....	279

## 1. Overview of Product Functions

Describes the main features that users need to know when using the NVR.

### Basic Features

- Support for network device access, including network cameras, IP domes and network video servers, as well as third-party network cameras.
- Support for the standard Onvif protocol.
- Each channel supports the preview of primary and secondary code streams.
- Each channel supports adjustable encoding parameters, including resolution, frame rate, code rate, image quality.
- Each channel supports regular functioning and alarming, custom 1, custom 2 and other intelligent video template parameters.
- Support for fast addition of IP channels.

### Local Monitoring

- Support for VGA and HDMI displays.
- Support for multi-screen video preview.

- Support for the preview of up to 1/3/4/6/8/9/10/13/16/20A/20B/25/32/36/40/64 screens.
- Support for the preview of shortcut menu operations.
- Support for front-end intelligent analysis.
- Support for video motion detection, video loss detection, video occlusion detection and port alarm detection.
- Support for a variety of mainstream PTZ control protocols, and also setting and recalling of preset position, cruise path and trajectory.

## **Hard Disk File Management**

- Support for hard disk SMART information display.
- Support for bad track detection.
- Support for setting of hard disk property: redundant, read-only, read-write and backup.
- Support for hard disk sleep.
- Support for hard disk pack quota, which can be divided into disk pack or different channels to allocate different video storage space.



- TC-R58(20/40/80) configuration: I/B/N 、 TC-R38(40/80) configuration: I/B/N(/Z) and TC-R31680 configuration: E/B/N(/Z) series devices support disk array.

## **Video Recording and Playback**

- The video trigger mode includes: timer and port alarm, motion detection alarm, detection or port alarm, detection and port alarm, video loss alarm, video occlusion alarm, intelligent analysis alarm and other alarm situations.
- Support for pre-recording and delay of linkage videos of all alarm types.
- Support for querying of video files by general conditions/events.
- Support for local redundant recording.
- Support for locking/unlocking of video files.
- Up to 4 video recording periods can be set a day, and the recording trigger mode in different periods can be set independently.
- Support for holiday plans.

- Support for querying of videos by channel number, video type, start and end time and file type.
- Support for several playback modes including regular playback, event playback, label playback, intelligent playback, video summary playback, time-phased playback, picture playback and external file playback.
- Support for video snapshot function. Different types of videos are distinguished with different colors.
- Support for pause, fast forward, slow, forward 30S, reverse 30S, step, step back, stop, one day before, one day after, as well as dragging your mouse for locating.
- Support for rolling your mouse wheel to zoom in and out the playback timeline.
- Support for digital zooming of any area.
- Support for video file playback function.
- Synchronous playback of up to 16 channels is possible for devices with 16 channels and above.

## **Data Backup**

- Support for backup of videos, pictures and other data via USB devices.
- Support for bulk backup by file range and type.
- Support for playback, clipping and backup of videos.
- Support for fast backup by channel and time.
- Support for management and maintenance of backup devices.

## **Alarm and Abnormality Management**

- Support for setting of the arming time of alarm inputs/outputs.
- Support for video loss, motion detection, video occlusion, port, intelligent analysis, detection or port, detection and port and other alarm detections. All the alarms can be linked to single-screen display, text plan, sound alert, email and alarm output, and can trigger the recording of any channel.
- Support for disk full, no disk, disk read/write error, illegal access, IP address conflict, MAC address conflict, no redundant disk available, network disconnection, abnormal hot standby, abnormal array, disk overloaded, abnormal recording, disk SMART abnormality, disk temperature abnormality and other abnormality detections. In addition, the POE equipment also

supports the POE overload detection. Various exceptions can trigger screen prompt, sound alert, upload center, email alarm and port alarm.

- When the system runs abnormally, the software watchdog can restart.

## **Other Local Features**

- Five-level user permission management allows an administrator to create more than one operation user and allocate them with proper permissions, which can be accurate to a certain channel.
- Complete logging and retrieval of operation, alarm, exception and information logs.
- Support for manual triggering and clearing of alarms.
- Support for import/export of device configuration information.

## **Network Features**

- Support for TCP/IP protocol cluster, and also PPPoE, DHCP, DNS, DDNS, NTP, SADP, NFS, HTTPS and other protocols.
- Embedded WEB server.

- Support for unicast and multicast. For unicast, TCP, UDP, and RTP protocols are supported.
- Support for remote search, playback, download, locking and unlocking of video files.
- Support for remote fetching and configuration of parameters, as well as remote export and import of device parameters.
- Support for remote fetching of equipment running state, system log and alarm state.
- Support for system maintenance operations such as remote formatting, updating and rebooting of hard disk.
- Support for alarm port expansion through alarm host.
- Support for remote manual triggering and stopping of video recording.
- Support for remote manual triggering and stopping of alarm outputs.
- Support for remote PTZ control.
- Support for voice intercom or voice broadcast.

## **Development Support**

- Provides SDK software development kits under Windows and Linux-based systems.
- Provides application software source code for demonstration.
- Provides development support and development training services for application systems.



#### **Notes:**

- Product features list the main features available from our company's NVR. Features depend on model specifications, intended purposes and configurations. The real product shall prevail.

## **2. Need-to-Know**

Describe the parts and accessories that users must know before using NVR: front and rear panels, mouse, and how to operate the device through these parts and accessories.

### **2.1 Introduction to Front panel**

Keys and indicator lights on the front panel are introduced.

The front panel of PSE series NVR, TC-R14(20/40) configuration: I/B/N, TC-R54(20/40) configuration: I/B/N, TC-R3440 configuration: I/B/N, TC-

R5110 configuration: I/B/N, TC-R5220 configuration: I/B/N standard series NVR is shown as below:

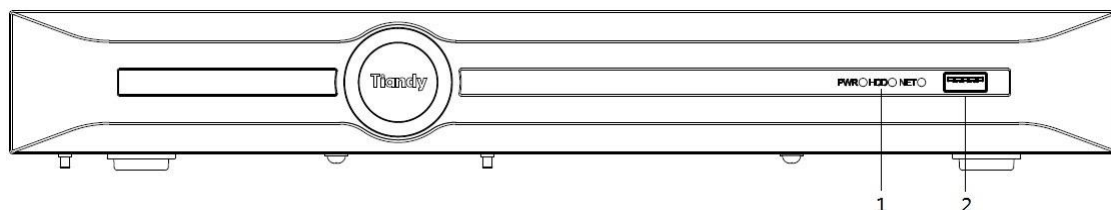

The functions of the front panel are shown in the following table:

S/N	Type	Name	Description
1	State indicators	PWRS	Power indicator; it is on when the device is connected to the power supply.
		HDD	HDD working indicator; it is on when the device reads from and writes to the HDD.
		NET	Network status indicator; it flashes in network communication mode.
2	Interface	USB interface	To connect to external mouse, USB device, mobile hard disk and other devices.

The front panel of TC-R11(05/10/20) configuration: I/B/V2.0, TC-R31(05/10/20) configuration: I/B standard series NVR, TCR1120 configuration: I/B/V2.0 multimedia NVR is shown as below:

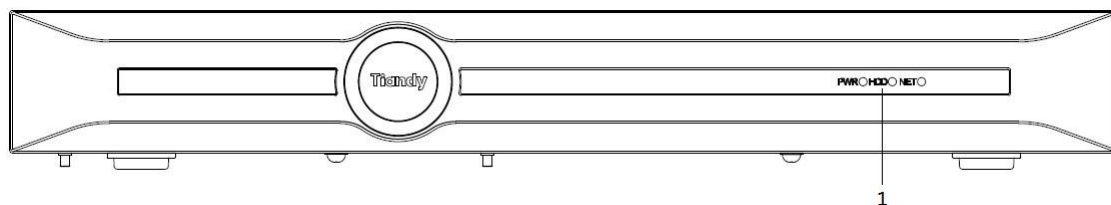

The functions of Status indicators on the front panel are shown in the following table:

S/N	Type	Name	Description
1	State indicators	PWRS	Power indicator; it is on when the device is connected to the power supply.
		HDD	HDD working indicator; it is on when the device reads from and writes to the HDD.
		NET	Network status indicator; it flashes in network communication mode.

The front panel of TC-R58(20/40/80) configuration: I/B/N, TC-R38(40/80) configuration: I/B/N, TC-R58(20/40/80) configuration: I/F, TC-R38(20/40/80) configuration: I/F/N series NVR is shown as below:



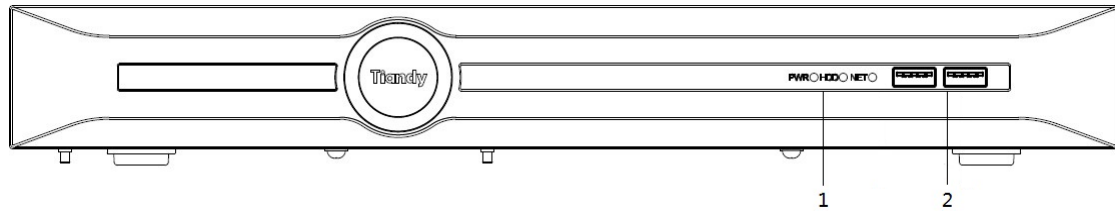

The functions of Status indicators on the front panel are shown in the following table:

S/N	Type	Name	Description
1	State indicators	PWRS	Power indicator; it is on when the device is connected to the power supply.
		HDD	HDD working indicator; it is on when the device reads from and writes to the HDD.
		NET	Network status indicator; it flashes in network communication mode.
2	Interface	USB interface	To connect to external mouse, USB device, mobile hard disk and other devices.

The front panel of TC-R516(40/80/160) configuration: E/B/N, TC-R31680 configuration: E/B/N series NVR is shown as below:

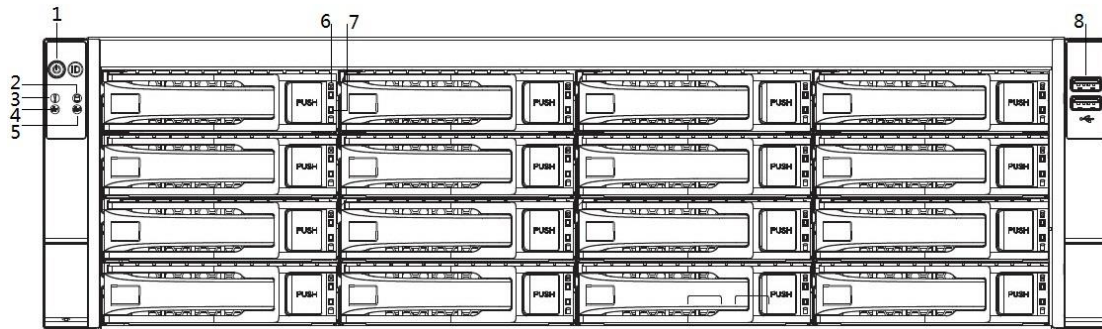

The functions of Status indicators on the front panel are shown in the following table:

S/N	Type	Name	Description
1	Key	POWER	ON/OFF button + power indicator.
2	Status indicator	Alarm indicator	When the equipment works abnormally, the indicator is on.
3	Status indicator	Running indicator	When the equipment works normally, the indicator light is on.

4	Status indicator	LAN1	Network card 1 status indicator; it flashes in network communication state.
5	Status indicator	LAN2	Network card 2 status indicator; it flashes in network communication state.
6	Status indicator	Hard disk error indicator	This indicator is on in red when the HDD works abnormally.
7	Status indicator	Hard disk running indicator	This indicator flashes in green when the HDD works normally.
8	interface	USB interface	To connect to external mouse, USB device, mobile hard disk and other devices.

## 2.2 Introduction to Rear Panel

The rear panel and interfaces of the equipment are introduced.

The interfaces on the rear panel of TC-R3105 configuration: I/B/P(/Z) series PSE NVR are shown as below:

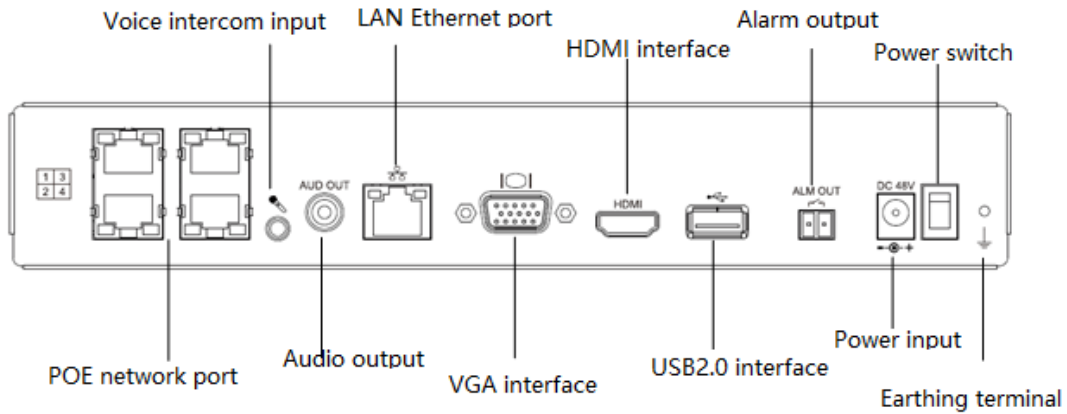

The interfaces on the rear panel of TC-R3210 configuration: I/B/P(/Z) series PSE NVR are shown as below:

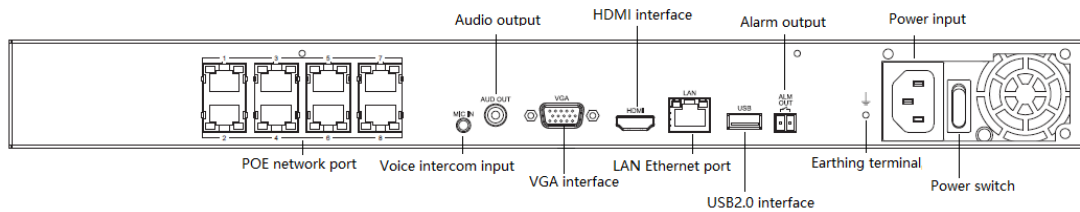

The interfaces on the rear panel of TC-R3220 configuration: I/B/P(/Z) series PSE NVR are shown as below:

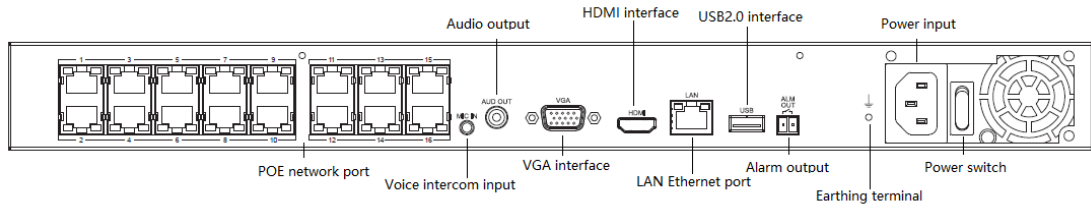

The interfaces on the rear panel of TC-R3220 configuration: I/B/P/H(Z) series PSE NVR are shown as below:

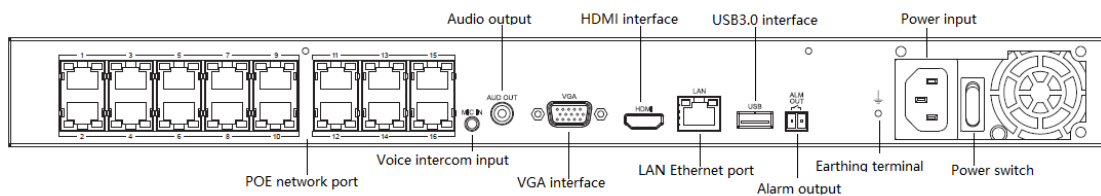

The interfaces on the rear panel of TC-R11(05/10/20) configuration: I/B TC-R31(05/10/20) configuration: I/B(Z) series NVR are shown as below:

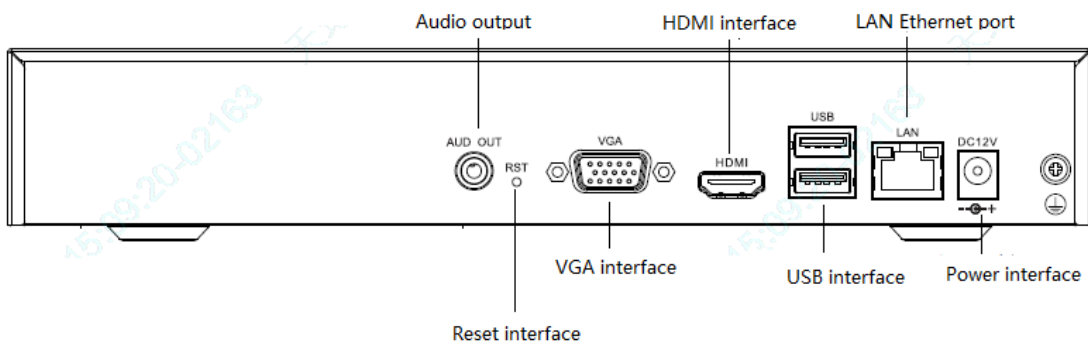

The interfaces on the rear panel of TC-R1230 configuration: I/B, TC-R12(10/20) configuration: I/B, TC-R32(10/20) configuration: I/B(/Z), TC-R5210 configuration: I/F, TC-R3210 configuration: I/F(/Z) series NVR are shown as below:

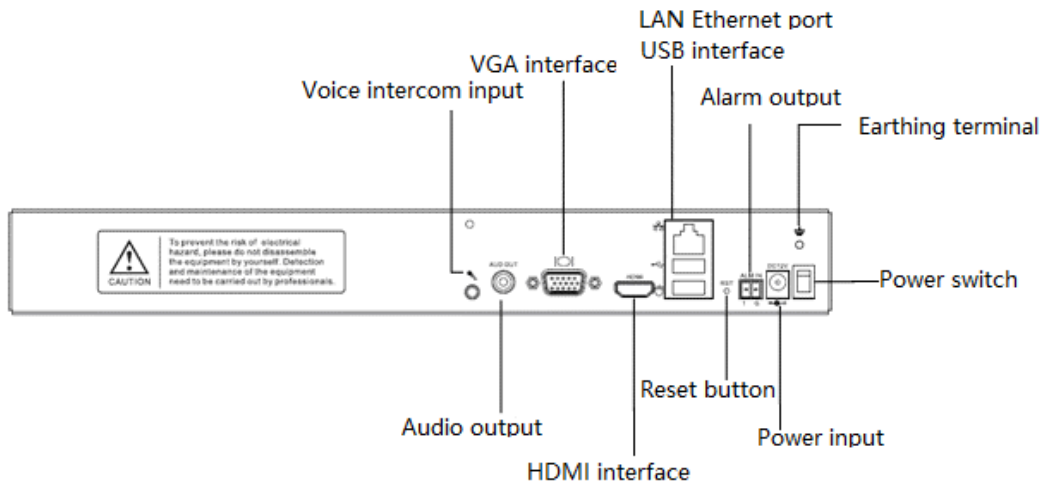

The interfaces on the rear panel of TC-R3105 configuration: I/F(/Z) series NVR are shown as below:

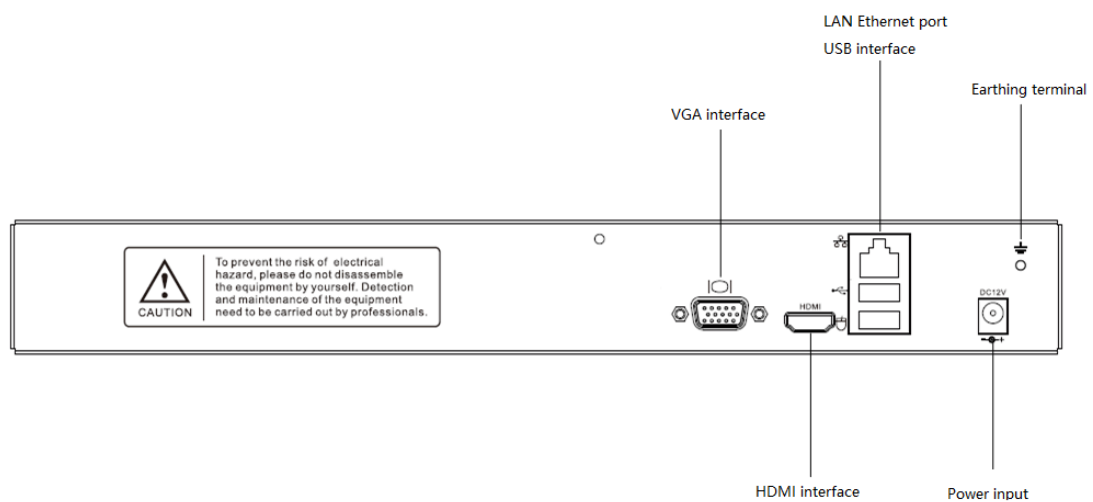

The interfaces on the rear panel of TC-R14(20/40) configuration: I/B/N, TC-R54(20/40) configuration: I/B/N, TC-R3440 configuration: I/B/N(Z) series NVR are shown as below:

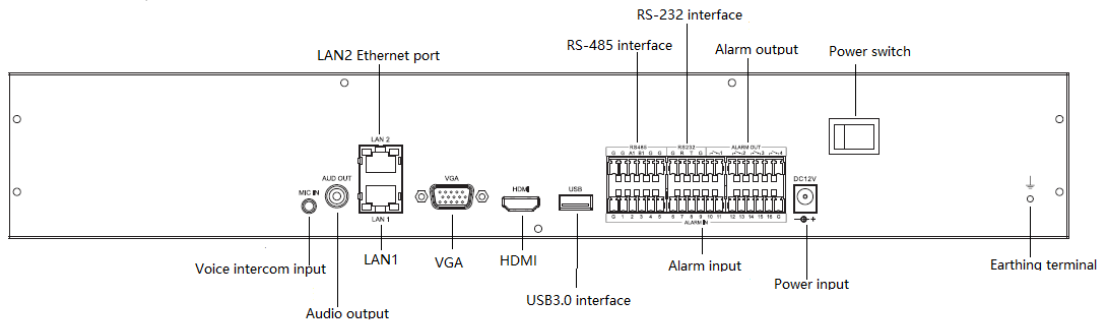

The interfaces on the rear panel of TC-R58(20/40/80) configuration: I/B/N, TC-R38(40/80) configuration: I/B/N(Z), TC-R58(20/40/80) configuration: I/F, TC-R38(20/40/80) configuration: I/F/N(Z) series NVR are shown as below:

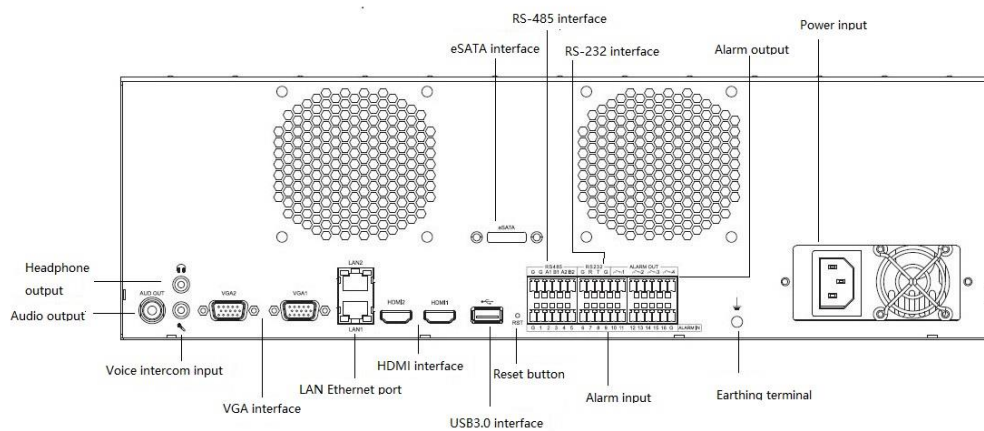

The interfaces on the rear panel of TC-NR2x enhanced series NVR (80 channels, 160 channels, 16 disk position) are shown as below:

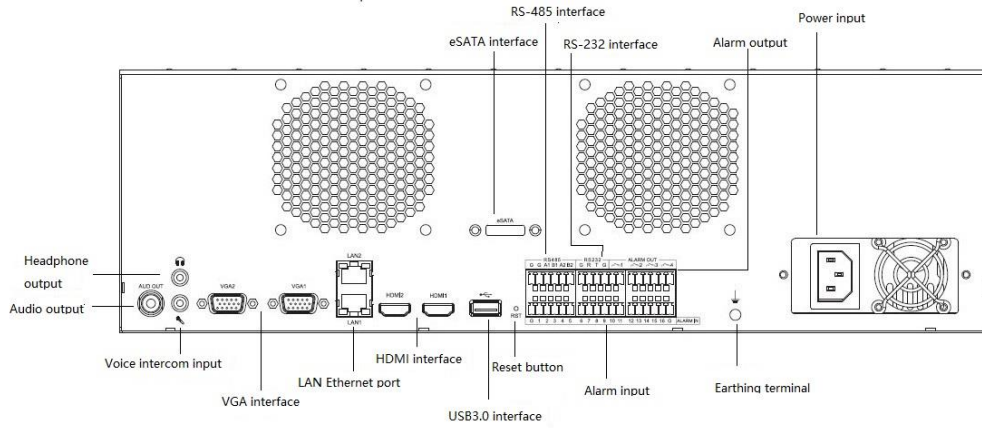

The interfaces on the rear panel of TCR1120 configuration: I/B/V2.0 multi-media NVR are shown as below:

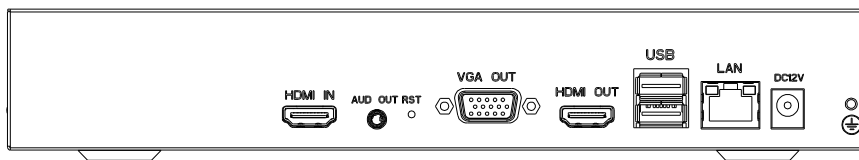

 **Note:**

- The schematic diagram illustrates the functions of interfaces on the front and rear panels only, and the specific chassis size shall be subject to the real product.



## 2.3 Instructions to Mouse Operations

After your mouse is connected to the USB interface, you can use your mouse to operate the device. For information about available operations, refer to the following table:

Name	Action	Description
Left-click	Click	<ul style="list-style-type: none"><li>● Preview: select a screen, display the fast add IP channel interface (When IP device channel is not added).</li><li>● Preview: display preview shortcut menu (when IP device channel is added).</li><li>● Menu: select and confirm.</li></ul>
	Double click	<ul style="list-style-type: none"><li>● Single screen, full screen, multi-screen display switch in preview and playback states.</li></ul>
	Press&hold and drag	<ul style="list-style-type: none"><li>● Turn directions in PTZ control mode.</li><li>● Set the area range when setting occlusion, motion</li></ul>

		<p>detection and video occlusion alarm area.</p> <ul style="list-style-type: none"> <li>● Drag the scroll bar where channel and time is displayed.</li> <li>● Switch between two preview screens.</li> </ul>
Right click	Click	<ul style="list-style-type: none"> <li>● Preview: to display the right-click menu.</li> <li>● Menu: exit the current menu and return to the previous level</li> </ul>
Mouse wheel	Swipe up	<ul style="list-style-type: none"> <li>● Up and down selection box, scroll-up options</li> <li>● Scroll bar, scroll-up pages</li> <li>● Increasing the multiplying factor (+) for digital zoom</li> </ul>
	Swipe down	<ul style="list-style-type: none"> <li>● Up and down selection box, scroll-down options</li> <li>● Scroll bar, scroll-down pages</li> <li>● Decreasing the multiplying</li> </ul>

		factor (-) for digital zoom
	Double click	<ul style="list-style-type: none"> <li>● Mouse switches between primary and secondary screens</li> </ul>

### 3. Installation and Connection

#### 3.1 Precautions for Installation



##### Warning:

Improper battery replacement is at the risk of explosion. The replacement operation is not recommended for users. To replace the battery, use the battery of the same type or equivalent type.

NVR is a special monitoring device which shall be installed by paying attention to the followings:

- Do not place containers containing (such as water glasses) liquid on the NVR.
- Install the NVR in a well-ventilated location. Install multiple devices such that they are spaced greater than 2cm.
- Operate the NVR under allowable temperature (-10°C ~ +55°C) and humidity (10% ~ 90%). (The H.265 series NVR with RAID mode

enabled operates under 0°C ~ +55°C; the H.265 series NVR E16 with redundancy mode enabled operates under +20°C ~ + 55 °C).

- Please remove the power cord to cut off the mains power before cleaning the device.
- Dust on the circuit board within the NVR, when dampened, may result in short circuit. Please regularly brush out dust on the circuit board, connectors, chassis and fan. If dirt is hard to be cleaned, use water-diluted neutral cleaner to remove it and then dry it.
- Do not use volatile solvents such as alcohol, benzene or diluent to clean the device, neither strong or abrasive cleaners, which may damage the surface coating.
- Please purchase monitoring-level SATA HDD from regular channels to ensure the quality and use requirements of the HDD. Seagate monitoring-level HDD is recommended.
- Please ensure that there is no danger due to uneven mechanical loads.
- Please make sure that the video cable and audio cable have enough space for installation, and the bending radius of the cable should not be less than 5 times the outer diameter of the cable.
- Please ensure that the NVR is reliably grounded.



**Note:**

- When you receive this product, please check against the " packing list" in the packing box. In case of any damage or missing accessories, please contact your vendor immediately.

### 3.2. Installing HDD

Our NVR device is not supplied with hard disk. A hard disk needs to be configured and installed according to your recording plan. Disassembly of the chassis and installation of the hard disk must be completed by professionals.



**Notes:**

- Please use the NVR dedicated monitoring-level hard disk recommended by the hard disk manufacturer.
- For the maximum number of hard disks installed on the device, refers to the instructions in the hard disk document.
- Make sure that the power supply is cut off before installation commences.

### 3.2.1 Calculation Method of HDD Capacity

Calculate the total capacity required for a hard disk video recorder according to the requirements of video recording (video type, video storage time), as detailed in the Appendix of this Manual.

Example:

<b>Bit Rate</b>	<b>File Size/Hour</b>	<b>Bit Rate</b>	<b>File Size/Hour</b>
96 Kbps	42 m.	128 Kbps	56 M
160 Kbps	70 M	192 Kbps	84 M
224 Kbps	98 M	256 Kbps	112 M
320 Kbps	140 M	384 Kbps	168 M
448 Kbps	196 M	512 Kbps	225 M
640 Kbps	281 M	768 Kbps	337 M
896 Kbps	393 M	1024 Kbps	450 M
1280 Kbps	562 M	1536 Kbps	675 M
1792 Kbps	787 M	2048 Kbps	900 M
3072 Kbps	1350 M	4096 Kbps	1800 M

8192 Kbps	3600 M	16384 Kbps	7200 M
-----------	--------	------------	--------

**⚠ Note:**

The data provided in the table above is for reference only. The estimation of "file size" in the table may deviate from the actual value, and any loss caused thereby shall be borne by the user.

### 3.2.2 HDD Installation Procedure

#### Installation tools

A cross screwdriver.

Installation diagrams (1) :

- 1、 Remove the screws on the rear and sides of the chassis and then remove the top cover.



- 2、 Connect one end of the HDD data cable to the SATA interface of the NVR master board Up, and the other end to the HDD.

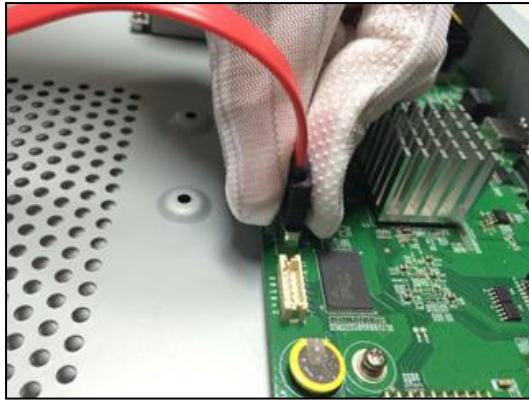

3、 Connect one end of the HDD power cable to the SATA interface of the NVR master board, and the other end to the HDD.

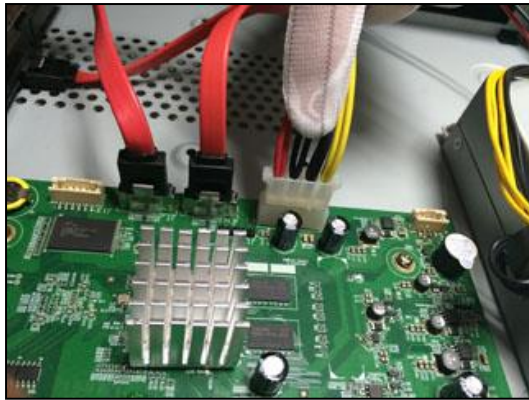

4、 Fix the HDD screws on the bottom of the NVR chassis, attach the top cover of the chassis and fix it with screws.

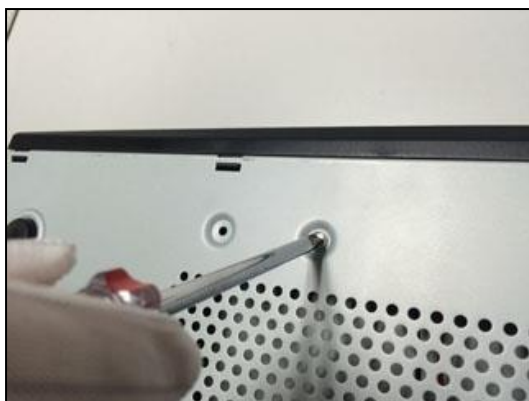

Installation diagrams (2) :



- 1、 Remove the screws on the back of the chassis, remove the top cover, and fix the hard disk to the chassis HDD holder.



- 2、 Connect one end of the HDD data cable to the SATA interface of the NVR master board, and the other end to the HDD.



- 3、 Connect the power cable to the hard disk, attach the top cover of the chassis and fix it with screws.

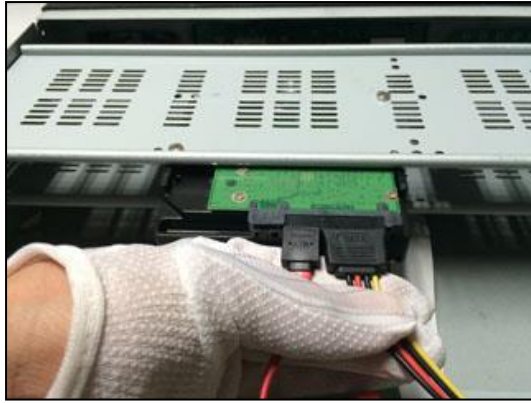

Installation diagrams (3): (installation of the front HDD)

- 1、 Attach the HDD mounting screws and insert it into the HDD slot on the front panel.



## 4. Local Configuration and Operation

### 4.1 Switch ON/OFF

#### 4.4.1 Switch ON

 **Note:**

- Make sure to use the power supply required by NVR before startup, and ensure that the NVR is well grounded.

- Make sure the NVR video output is properly connected to the monitor before startup.
- Abnormal power supply will result in malfunctioning of NVR or even damage. It is recommended to use stabilized power supply for power supply.

1. Connect the power supply and turn on the power switch on the rear panel. The device starts with a "beep" sound.

2. NVR displays the following screen at startup:



#### 4.1.2. Switch OFF

1. Select "Main Menu -> " to enter the logoff interface, as shown in the figure below.

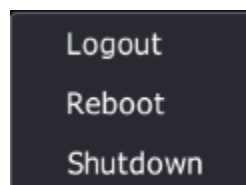

2. Users can click logoff to restart or shut down system.

 **Notes:**

- Please do not cut off the power supply when the system is displaying "The system is shutting down..."
- Do not cut the power supply off when the device is running.

## 4.2 Equipment Activation

**After the device is started, the device can be configured with password and secret protection through device activation to ensure the normal login and password security of the device.**

- 1、 First, on the password setting interface, enter the password twice, and click Next to enter the next interface.

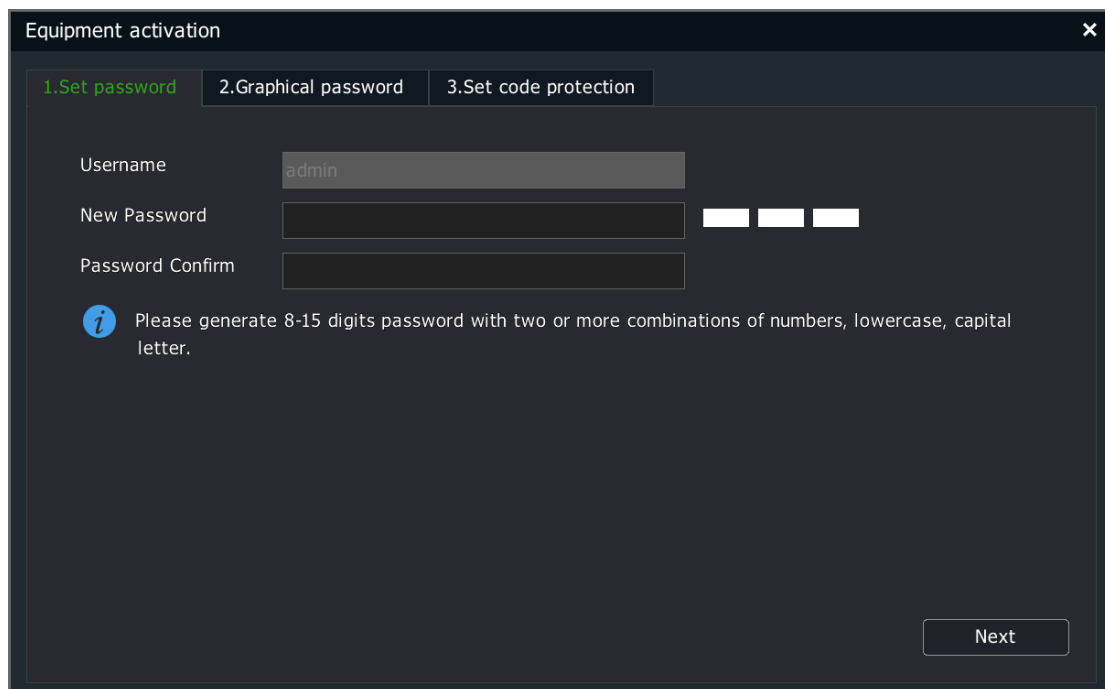

The screenshot shows a dark-themed window titled "Equipment activation" with a close button (X) in the top right corner. At the top, there are three tabs: "1.Set password" (highlighted in green), "2.Graphical password", and "3.Set code protection". Below the tabs, there are three input fields: "Username" with the text "admin", "New Password" (with three white squares to its right), and "Password Confirm". Below the input fields, there is an information icon (i) followed by the text: "Please generate 8-15 digits password with two or more combinations of numbers, lowercase, capital letter." At the bottom right, there is a "Next" button.

- 2、 On the graphic password setting interface, set an unlock pattern, and then automatically enter the password setting interface. Click Previous

to return to the password setting interface, or click Skip not to set the graphic password.

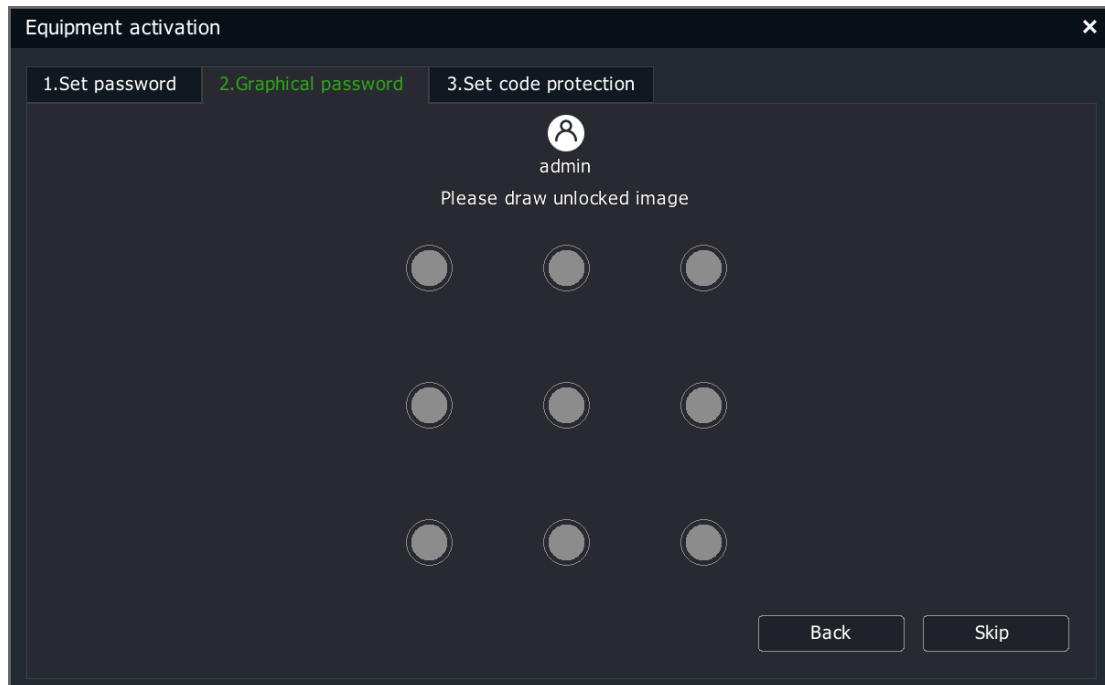

- 3、 On the security question setting interface, set the mailbox and security question. You can skip this step directly into the boot wizard. The mailbox and security questions are used for password resetting.

Equipment activation

1.Set password 2.Graphical password 3.Set code protection

Reserved Email  (For Password Reset)

Code protection question

Question 1

Answer

Question 2

Answer

Please delete the previous if you want to change code

Confirm Skip

### 4.3 Boot Wizard

**After the device is started, the device can be simply configured through the boot wizard to ensure the normal operation of the device.**

1. First, on the Setup Wizard interface, set the current language and resolution of output device. Click "Next" to enter the next interface.

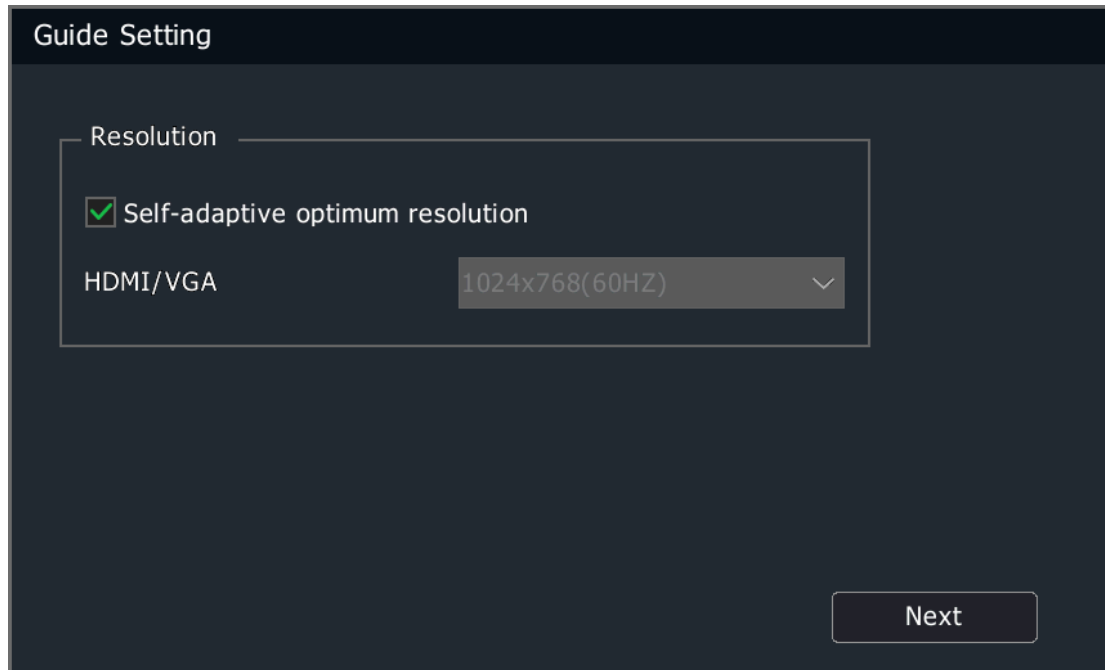

2. On the Setup Wizard interface , select whether to run the boot wizard.  
Click "Yes" to enter the next interface, "No" to skip the boot wizard, or "Never" to close the boot wizard. In the third case, the boot wizard will be skipped at the next startup.

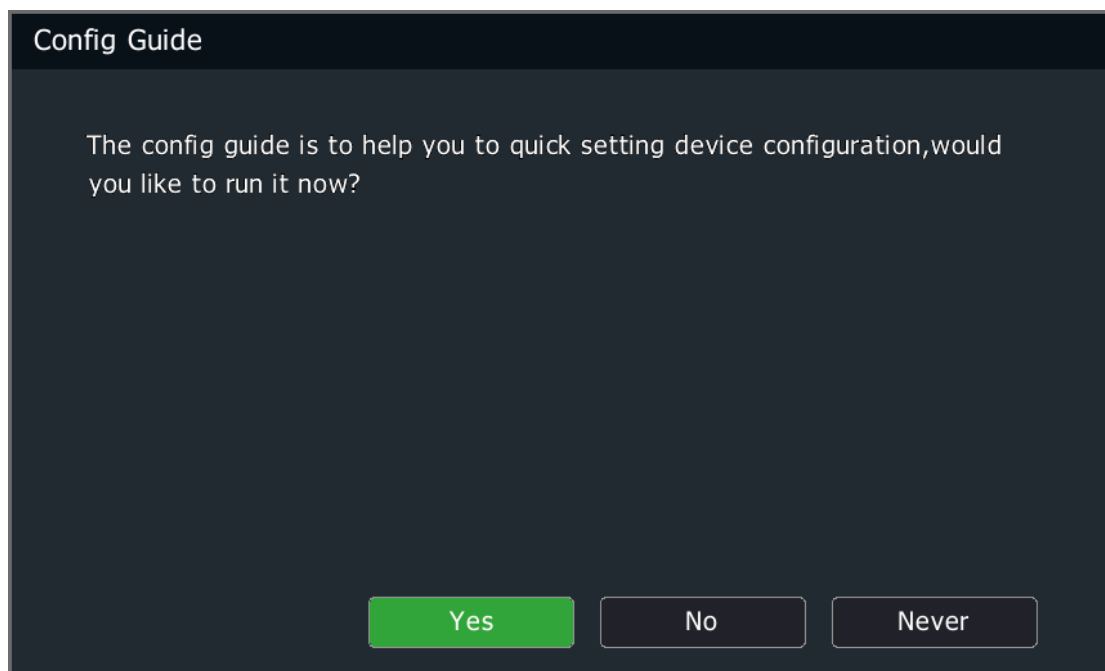

3. On the Authentication interface, a user shall log in as administrator "admin" for authentication. Click "OK" to confirm the account. After authentication is successful, the boot wizard appears. The device will be locked for 5 minutes if you input the wrong password for 5 consecutive times. Click Cancel to skip the boot wizard.

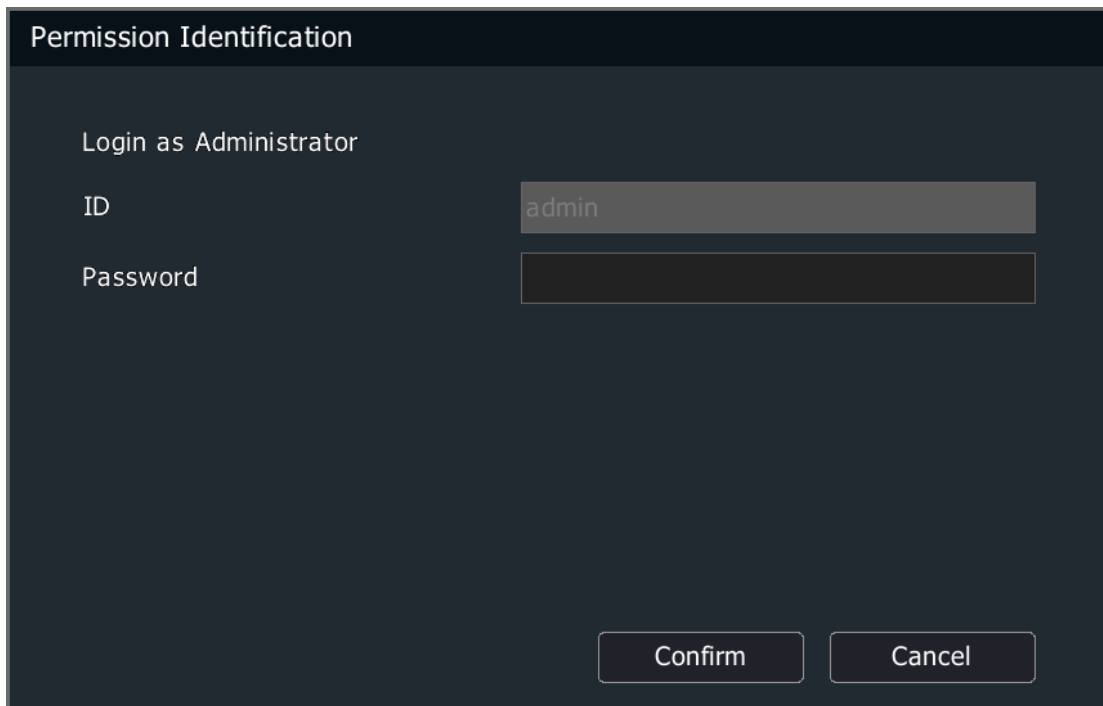

Permission Identification

Login as Administrator

ID

Password

Confirm Cancel



**Note:**

- Administrator: admin, password: (boot password set in Section 4.2 Device Activation).

4. On the time and time zone setting interface, click "Apply" to set the time zone, time format and time; click "Next" to enter the next interface; and click "Exit" to exit the boot wizard.



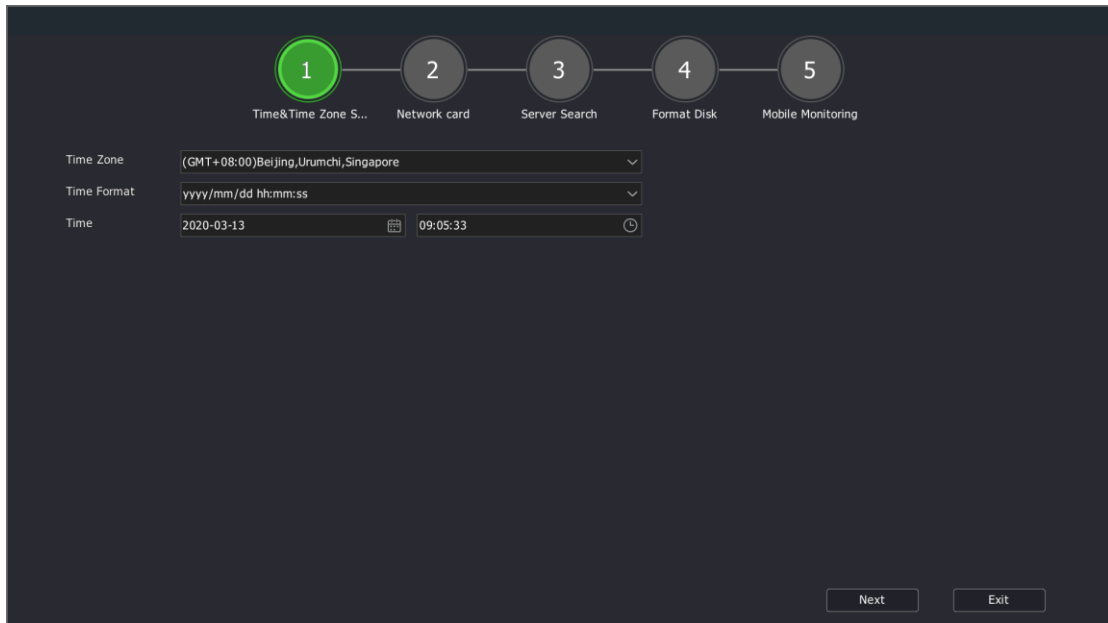

5. On the network setting interface, click "Back" to return to the previous interface; click "Next" to set network parameters and enter the next interface; and click "Exit" to exit the boot wizard.

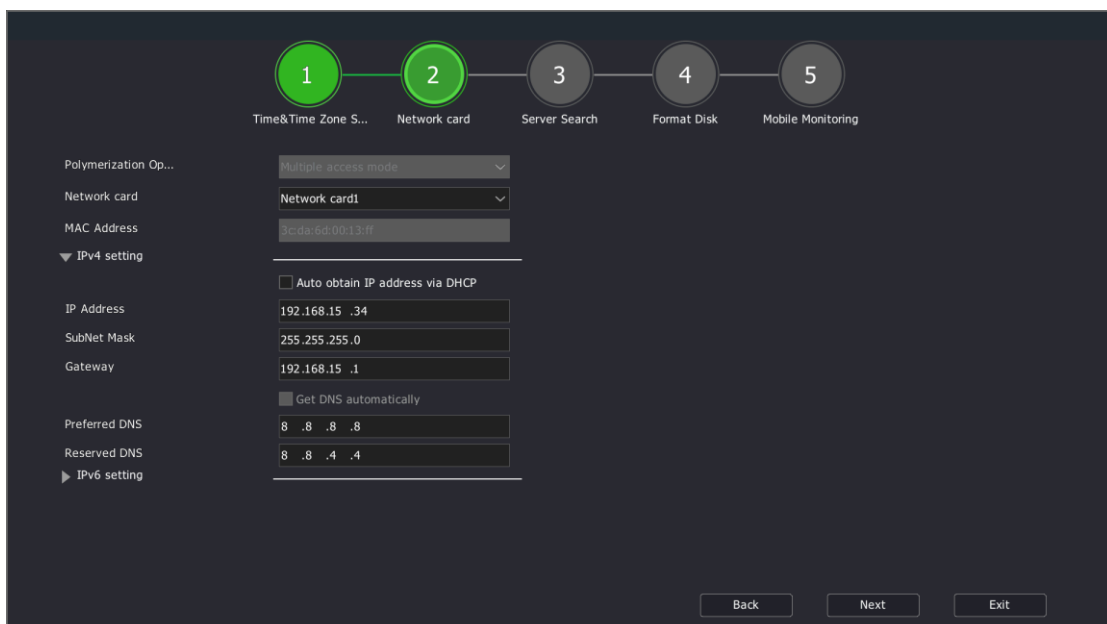

6. On the server searching interface, you can configure digital channels. Click "Search" to search digital channels; click "Back" to return to the

previous interface; click "Next" to enter the next interface; and click "Exit" to exit the boot wizard.

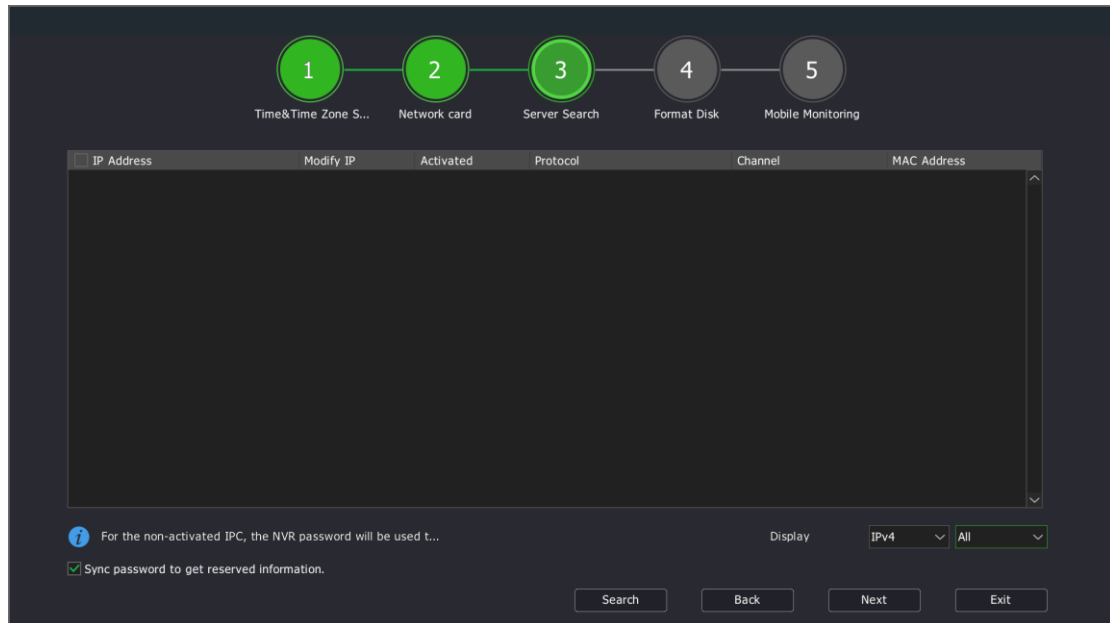

7. On the formatting disk interface, click "Initialize" to format the selected disk; click "Previous" to return to the previous interface; click "Next" to enter the next interface; and click "Exit" to exit the boot wizard.

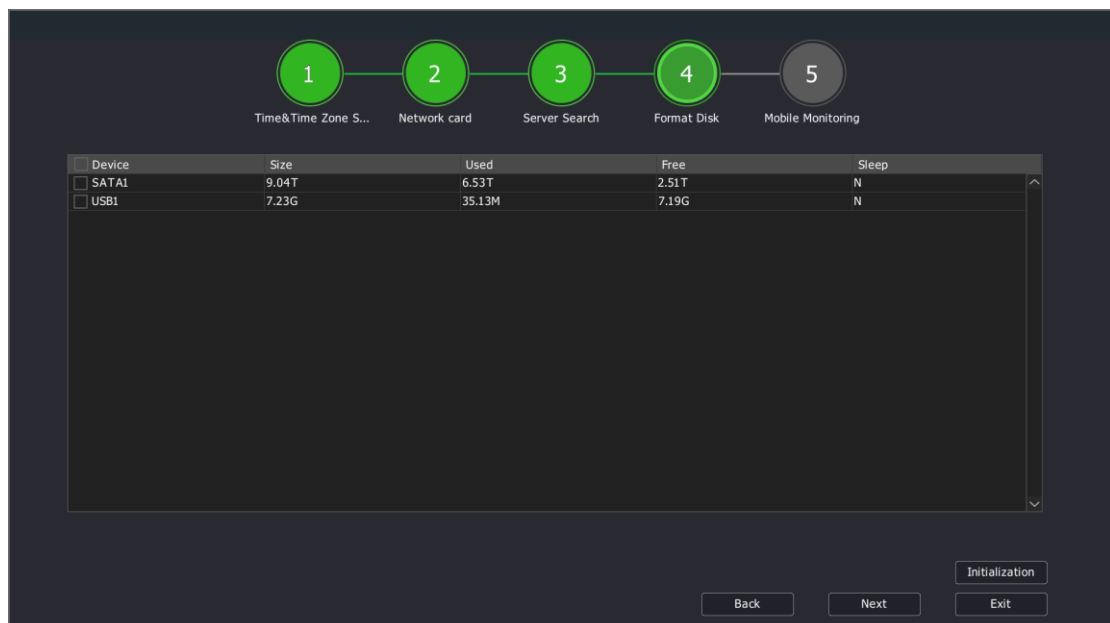

 **Note:**

- The disk must be initialized before recording properly.

8. On the mobile monitoring interface, you can configure control devices on the mobile side. Click "Back" to return to the previous interface; click "Next" to enter the next interface; and click "Exit" to exit the boot wizard.

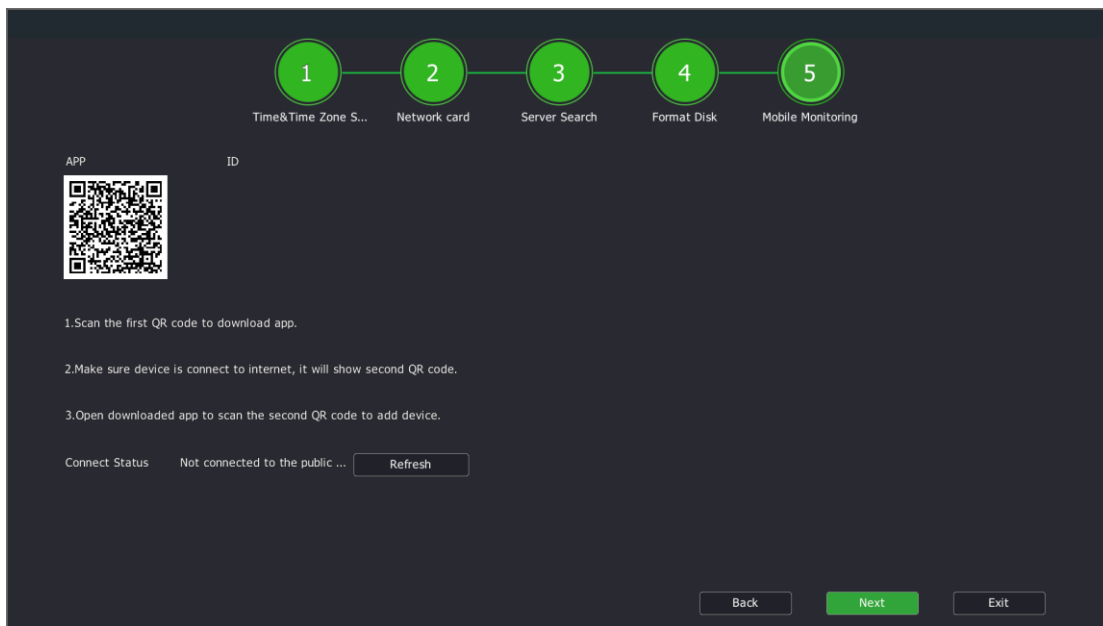

 **Note:**

- Some device models use QQ for mobile monitoring. The real product shall prevail.

9. If there is still a hard disk in the system that has not been formatted, the following message as shown in the figure below will appear. Click "Execute" to automatically format the unformatted disks in the system one by one; and click "Back" to enter the preview screen directly.

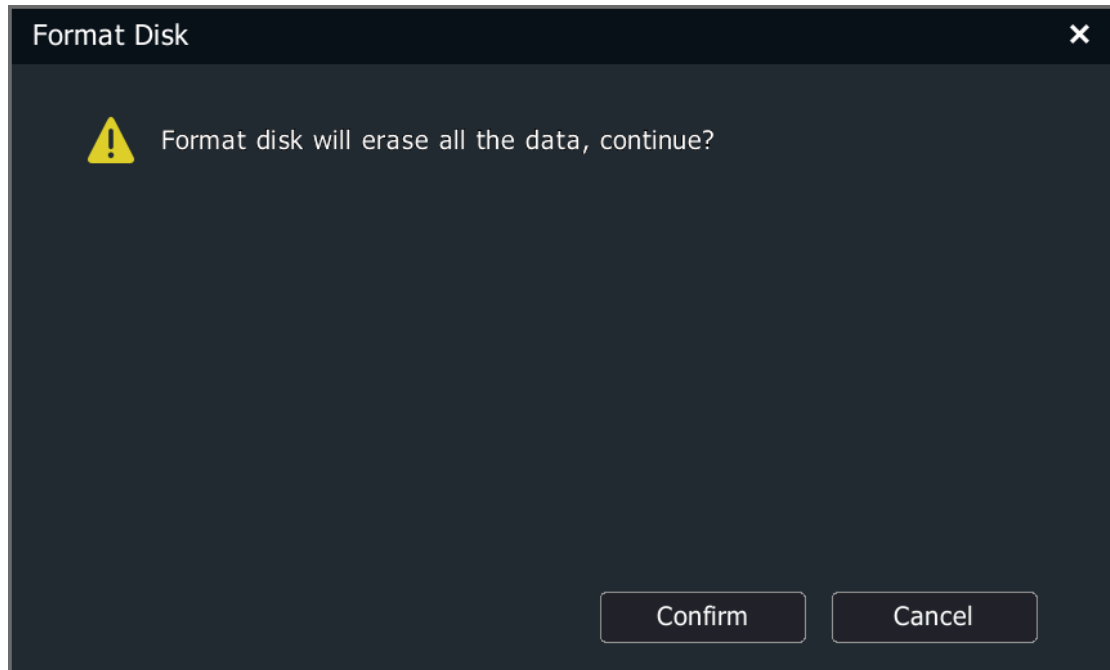

## 4.4 Cameras

### 4.4.1 Adding Channels from the Shortcut Bar

Users can easily add an IP channel to the device with one click. If no channel is added, the preview status is shown as below.

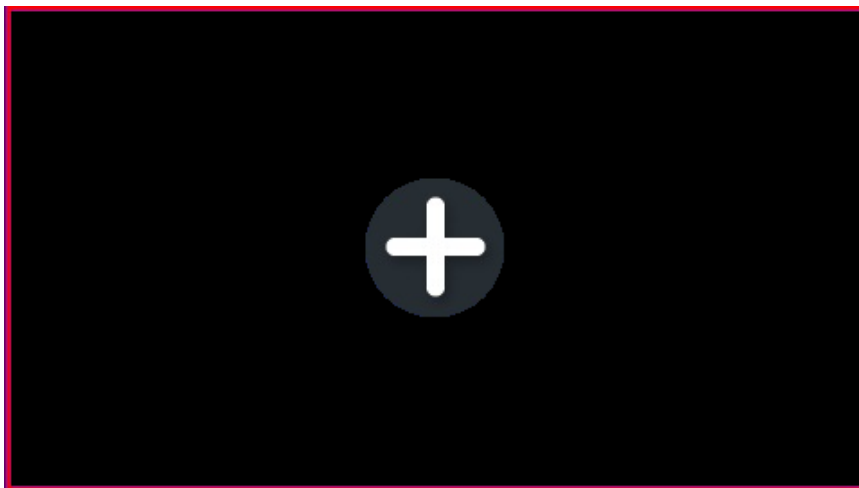

- 1、 On the preview interface, click a channel to display the "+" sign, and the server search form appears, as shown in the figure below.

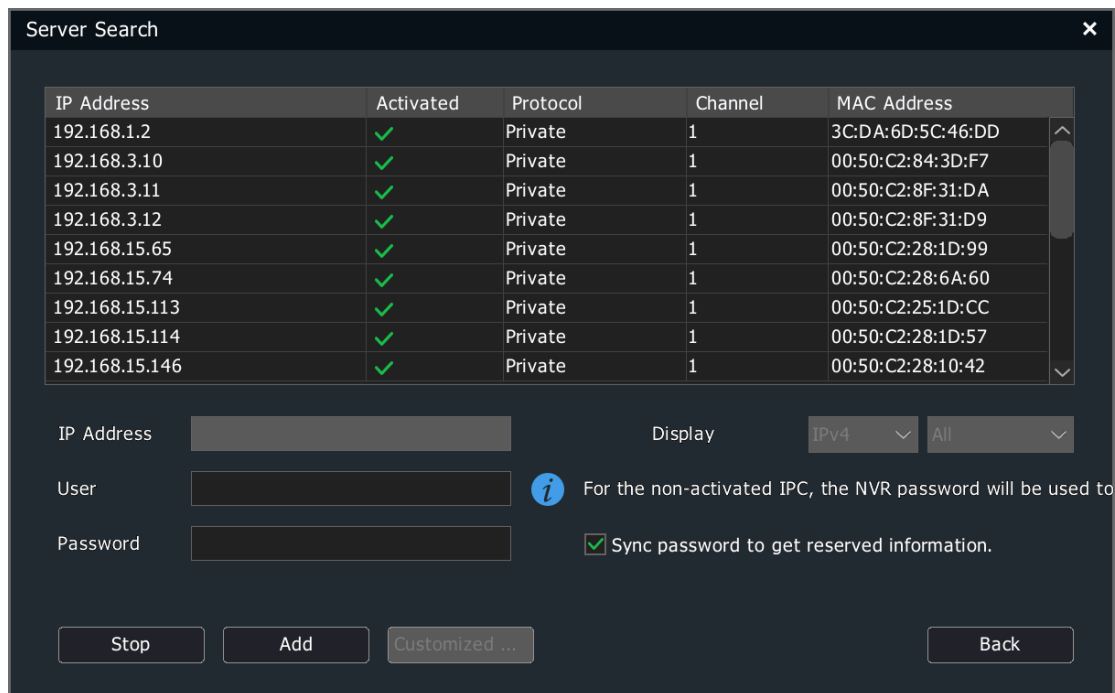

 **Note:**

- A channel is added with default port, username and password; if not, you can choose "Custom Add".

2. After the search is completed, double-click the search list or select the channel and click "Add" to complete the addition.

3. Users itself can also configure parameters to add digital channels. Click "Customized Adding" to display the "Customized Adding" form, as shown in the figure below.

Customized Adding
✕

Channel No.	<input type="text" value="[01]Channel 1"/>
Protocol	<input type="text" value="Private Protocol"/>
Connect mode	<input type="text" value="IPv4"/>
Device Address	<input type="text" value="0.0.0.0"/>
Port No.	<input type="text" value="3000"/>
Proxy IP	<input type="text"/>
Device Channel	<input type="text" value="01"/>
User	<input type="text" value="admin"/>
Password	<input type="text" value="****"/>
Decryption	<input type="text"/>

For the non-activated IPC, the NVR pas...

Sync password to get re...

4. Enter the IP address, port number, user name, password and other information of the front end.

**Note:**

- If it is the local channel of PSE-NVR and there is no connection, the add method of the PSE channel will automatically be changed to manual add after fast addition. The plug&play function is enabled by default for the POE port of the PSE series NVR. Please do not connect it to the LAN; otherwise, IP addressed of other devices in the LAN will be automatically modified.

## 4.4.2 Adding Digital Channels Using Regular Methods

1. Select "Main Menu -> Cameras -> Channels -> Basic Configuration" to enter the channel configuration interface, as shown in the figure below.

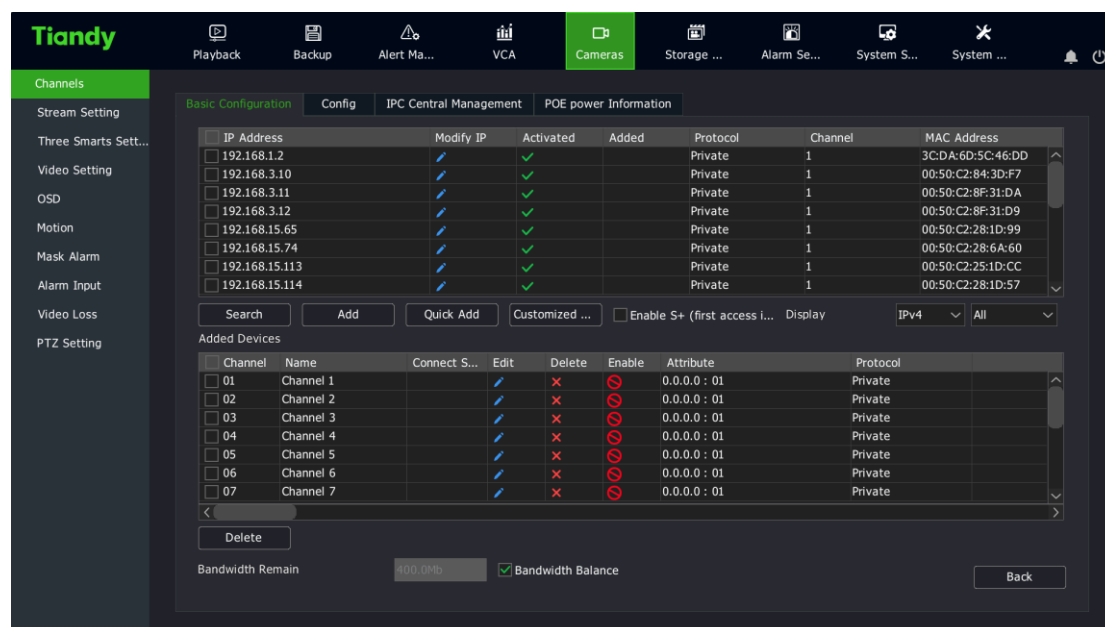

### Notes:

- This page displays different tabs for different device models.
- After addition is complete, you can check the results in the added device list.
- Click connect status to directly preview the video of this channel.
- When the connection status displays an exclamation point, move the mouse over the icon to show the cause of the connection failure.

2. Click "search" to begin searching. Search results are automatically sorted by IP address. You can modify the IP front end in the search results list. Click  to display the modify IP interface, as shown in the figure below.

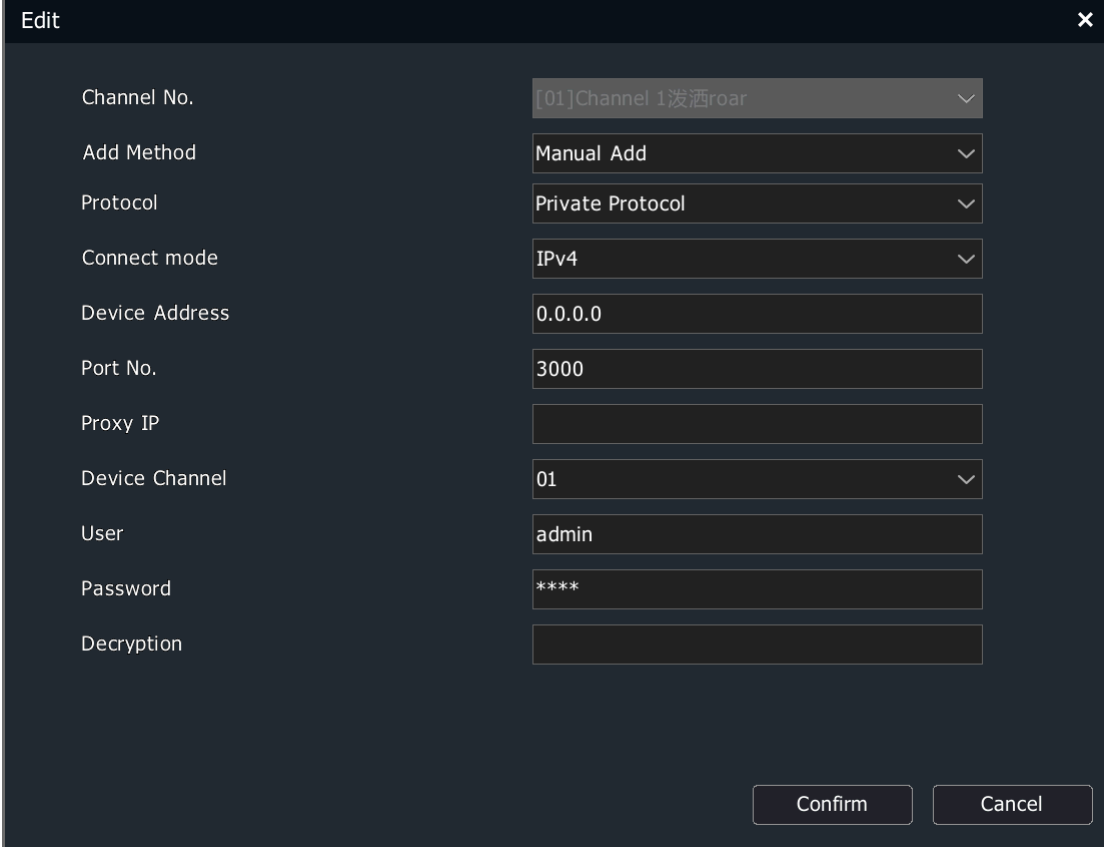

Channel No.	[01]Channel 1 泼酒roar
Add Method	Manual Add
Protocol	Private Protocol
Connect mode	IPv4
Device Address	0.0.0.0
Port No.	3000
Proxy IP	
Device Channel	01
User	admin
Password	****
Decryption	

Confirm Cancel

3. Select the IP channel to add from the search list, click "Add" or double-click the mouse, and the IP device will be added to the idle channel of NVR. You can add multiple IP channels. The channel search is shown as below.



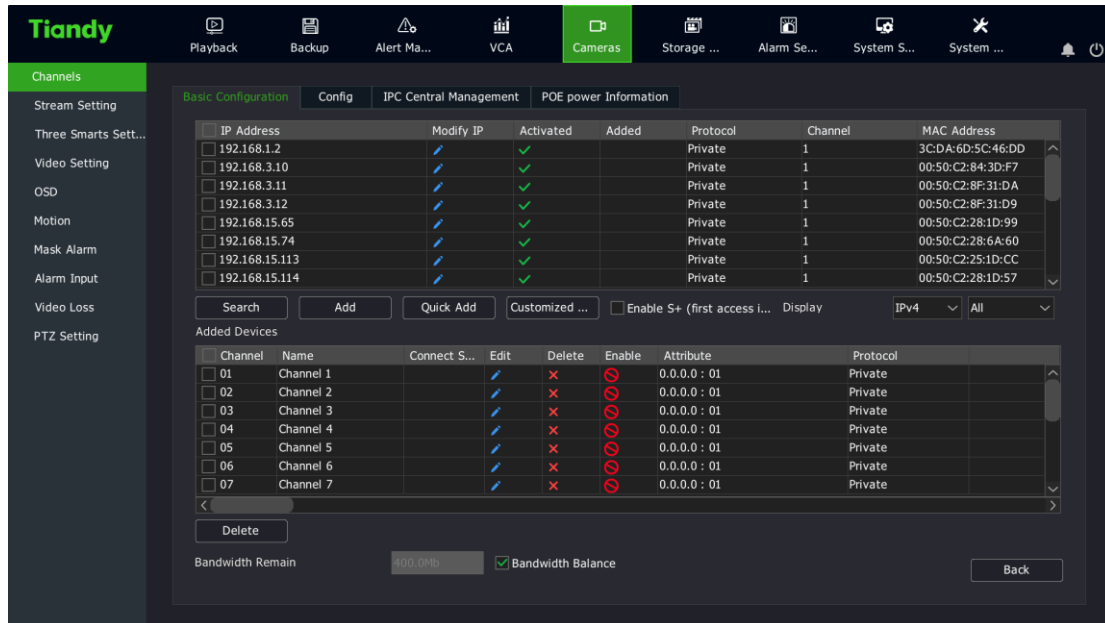

4. When adding an inactive IPC, an activation pop-up window will appear as shown in the figure below. Check the "Synchronize information retained for retrieving the password", the retained information will be synchronized to the front end and activated.

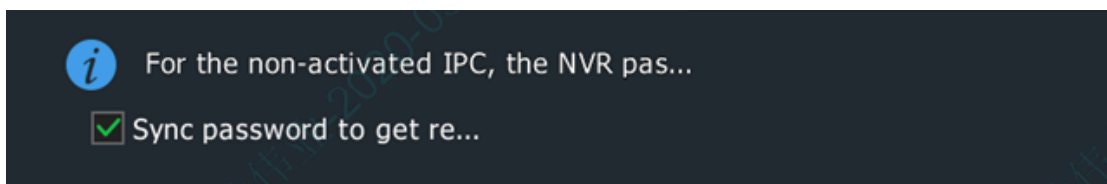

### Note:

- If the add method for PSE-NVR's digital channel is plug and play , then this channel is busy.

## Customized Adding

- 1、 On the Channel Config -> Basic Configuration interface, click "Custom Add" to enter the digital channel interface; when device type

is private protocol, proceed as shown in the figure below.

Customized Adding

Channel No. [01]Channel 1

Protocol Private Protocol

Connect mode IPv4

Device Address 0.0.0.0

Port No. 3000

Proxy IP

Device Channel 01

User admin

Password \*\*\*\*

Decryption

*i* For the non-activated IPC, the NVR pas...

Sync password to get re...

Batch Adding Continue to add Add Cancel

2、 Select the channel number to add, check Enable, and select the connection mode according to the device type. When device type is RTSP, proceed as shown in the figure below.

Customized Adding ✕

Channel No.	[01]Channel 1 <span>▼</span>
Protocol	RTSP <span>▼</span>
Network Type	TCP <span>▼</span>
Main stream URL	rtsp://
Sub-stream URL	rtsp://
User	admin
Password	****

 For the non-activated IPC, the NVR pas...

Sync password to get re...

Batch Adding Continue to add Add Cancel

When device type is ONVIF, proceed as shown in the figure below.

Customized Adding
✕

Channel No.	<input type="text" value="[01]Channel 1"/>
Protocol	<input type="text" value="ONVIF"/>
Connect mode	<input type="text" value="IPv4"/>
Network Type	<input type="text" value="TCP"/>
Device Address	<input type="text" value="0.0.0.0"/>
Port No.	<input type="text" value="80"/>
Proxy IP	<input type="text" value=""/>
Device Channel	<input type="text" value="01"/>
User	<input type="text" value="admin"/>
Password	<input type="text" value="*****"/>
Decryption	<input type="text" value=""/>

i For the non-activated IPC, the NVR pas...

Sync password to get re...

3. After entering the IP address or URL address and username and password of the front-end device, click "OK" to add a digital channel. Repeat this operation to add other digital channels.

 **Notes:**

- If the device to add is a multi-channel NVR, you can select the channel number to add from "Channels", and also can add multiple channels for one NVR at a time.
- Continue adding, batch adding, adding according to the add rule and target channel, and skipping the current channel if the current

channel is included in the target channel. If the IP address is ascending, the last bit of IP, after 255, will not be incremented.

- When device type is ONVIF, the port number defaults to 80, and the username and password default to admin. The login account and password may vary from manufacturer to manufacturer, which needs to be modified according to the actual situations.

#### 4.4.3 Adding POE Camera

- 1、 On the Channel Config -> Basic Configuration interface, click  in the added device list or double-click a PSE channel to enter the digital channel interface.

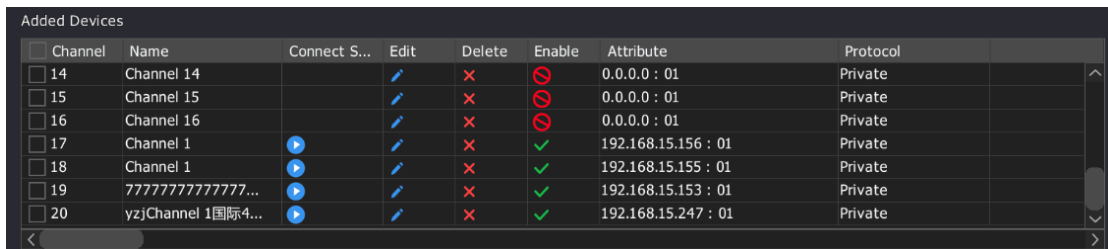

Channel	Name	Connect S...	Edit	Delete	Enable	Attribute	Protocol
<input type="checkbox"/> 14	Channel 14					0.0.0.0 : 01	Private
<input type="checkbox"/> 15	Channel 15					0.0.0.0 : 01	Private
<input type="checkbox"/> 16	Channel 16					0.0.0.0 : 01	Private
<input type="checkbox"/> 17	Channel 1					192.168.15.156 : 01	Private
<input type="checkbox"/> 18	Channel 1					192.168.15.155 : 01	Private
<input type="checkbox"/> 19	7777777777777...					192.168.15.153 : 01	Private
<input type="checkbox"/> 20	yzjChannel 1国际4...					192.168.15.247 : 01	Private

- 2、 A PSE channel can be added by means of "Plug & Play" and "Manual Add" :

(1) If "Manual Add" is selected, the device shall be connected to the network interconnected with IP channels. Other configuration methods are the same as adding ordinary digital channels.

(2) If "Plug & Play" is selected, the front end to add shall be connected to the device's independent POE-powered Ethernet port. The device will

complete the connection automatically.

#### 4.4.4 Quick Add

In order to allow users to quickly add devices, users can choose to enable the "Quick Add" function to add channels. In this mode, the device will be automatically searched and added to the digital channel.



#### Notes:

- The "Quick Add" function will automatically search for IPC and add it to the idle channel. Please pay due attention when using it.
- The PSE device channel list cannot be removed manually.

#### 4.4.5 Configuration Management

Users can import and export all channel parameter configurations through configuration management.

1. Select "Main Menu -> Cameras->Channels -> Config" to enter the configuration management interface. If a mobile storage device is connected, clicking Export can export all channel configuration parameters, which are saved as .xls format file. Users can manually edit exported parameters on the computer and use them as input parameters, as shown in the figure below.

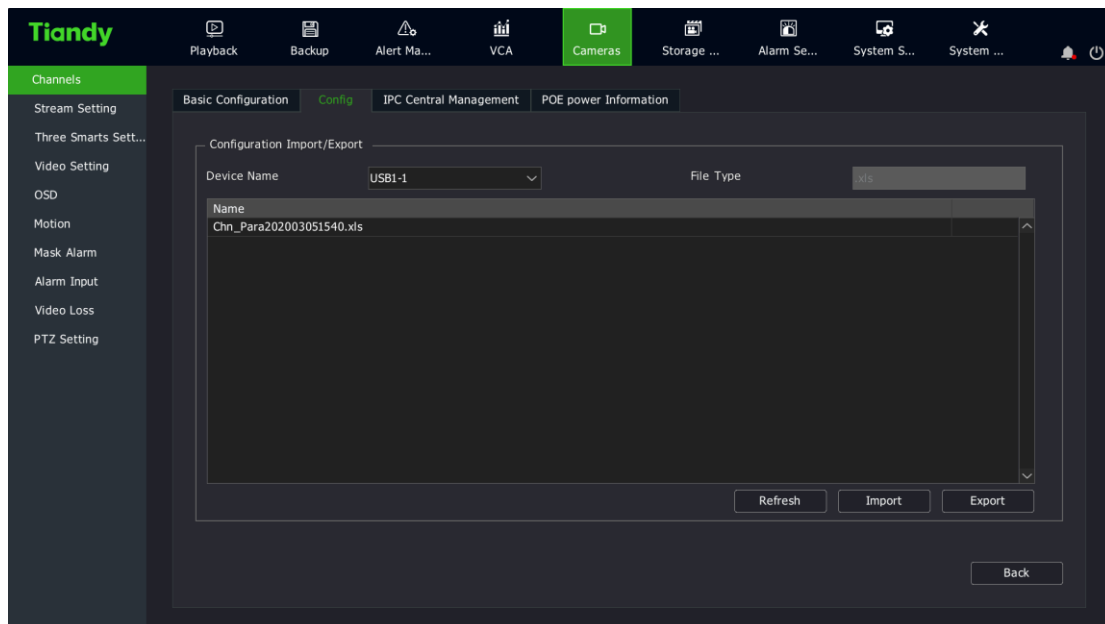

2. Importing contents contained in the exported .xls file shall meet the following formats.

Chn NO.	Enable	Server Type	Server Url	Server Proxy	Chn Type	Chn NO.	Net Mode	Connect Moc	Server Port	Mult IP	Mult Port	User Name	Password	Decrypt psw	rtspurl	Preview Mode	Plug Mode
1	1	Private	192.168.15.2		0	1	0	0	3000			admin	1111		192.168.15.2	0	1
2	1	Private	0.0.0.0		0	1	0	0	3000			admin	1111		0.0.0.0	0	1
3	1	Private	192.168.15.2		0	1	0	0	3000			admin	1111		192.168.15.2	0	1
4	1	Private	0.0.0.0		0	1	0	0	3000			admin	1111		0.0.0.0	0	1
5	0	Private	0.0.0.0		0	1	0	0	3000			admin	1111			0	2
6	1	Private	192.168.15.1		0	2	0	0	3000			admin	1111		192.168.15.1	0	1
7	1	Private	192.168.15.1		0	1	0	0	3000			admin	1111		192.168.15.1	0	1
8	1	Private	192.168.15.1		0	2	0	0	3000			admin	1111		192.168.15.1	0	1
9	0	Private	0.0.0.0		0	1	0	0	3000			admin	1111			0	2
10	0	Private	0.0.0.0		0	1	0	0	3000			admin	1111			0	2
11	0	Private	0.0.0.0		0	1	0	0	3000			admin	1111		0.0.0.0	0	1
12	0	Private	0.0.0.0		0	1	0	0	3000			admin	1111			0	2
13	0	Private	0.0.0.0		0	1	0	0	3000			admin	1111			0	2
14	0	Private	0.0.0.0		0	1	0	0	3000			admin	1111			0	2
15	0	Private	0.0.0.0		0	1	0	0	3000			admin	1111			0	2

Wherein:

- (1) In "Enable ", 0: channel not enabled, 1: channel enabled;
- (2) In "Chn Type ", 0: main stream, 1: secondary stream, 2: picture stream;
- (3) In "Net Mode ", 1: TCP, 2: UDP, 3: multicast;
- (4) In "Connect Mode ", 0: IP, 1: domain name, 2: active mode;
- (5) In "Preview Mode ", 0: tiled on the display area, 1: wide-screen proportional display is maintained.

3. Exported .xls files can be edited with Office 2003 and above and imported into the device.

#### 4.4.6 IPC Central Management

The centralized management function of IPC allows users to import and export parameters of the added front-end devices, upgrade them remotely, and restart IPC.

1. Select "Main Menu -> Cameras -> Channels -> IPC Central Management" to enter the IPC centralized management interface, as shown in the figure below.

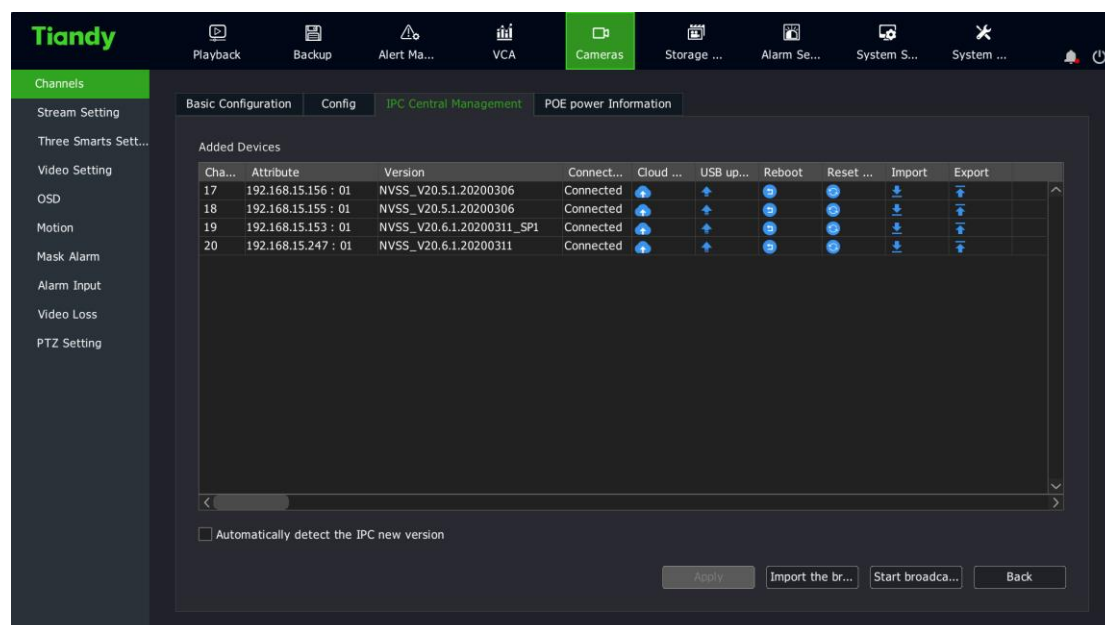

#### Note:

- The interface can display the channel number, property, version number and connection status of the added front-end device, and



allow perform cloud upgrade, parameter import and export, remote upgrade, IPC restart and other operations.

## 2. Configuration Import/Export

(1) Select the front end to operate from the added device list.

(2) Click "" to display the configuration import prompt box, as shown in the figure below.

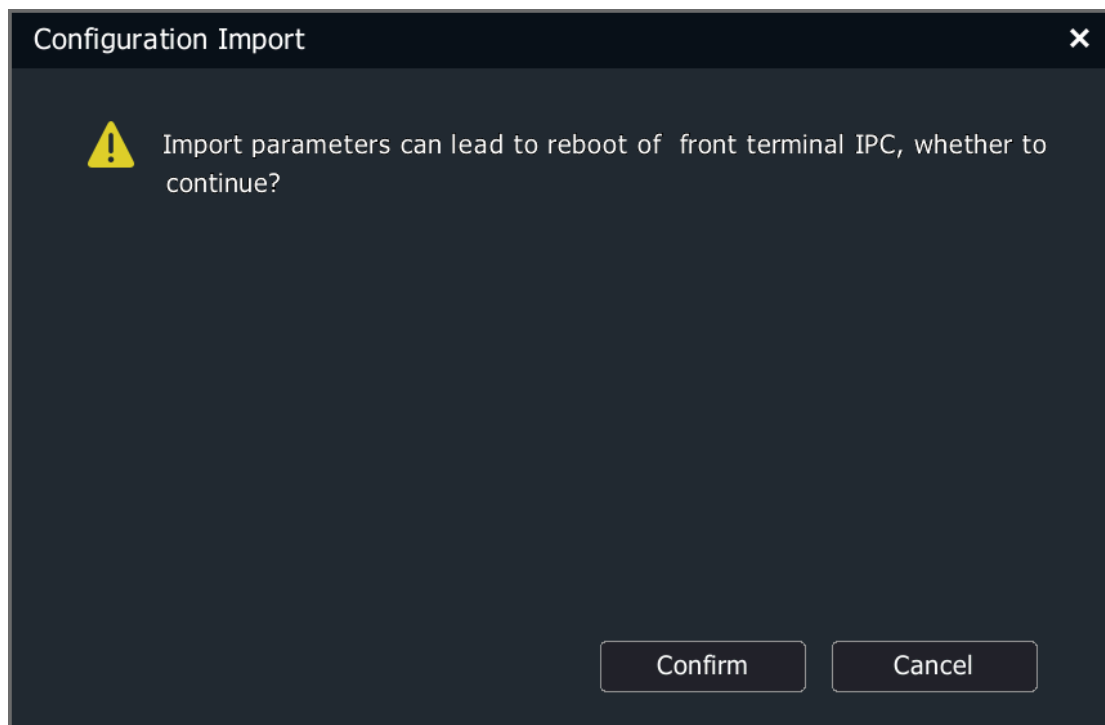

(3) Click "ok" to enter the configuration import interface, as shown in the figure below.

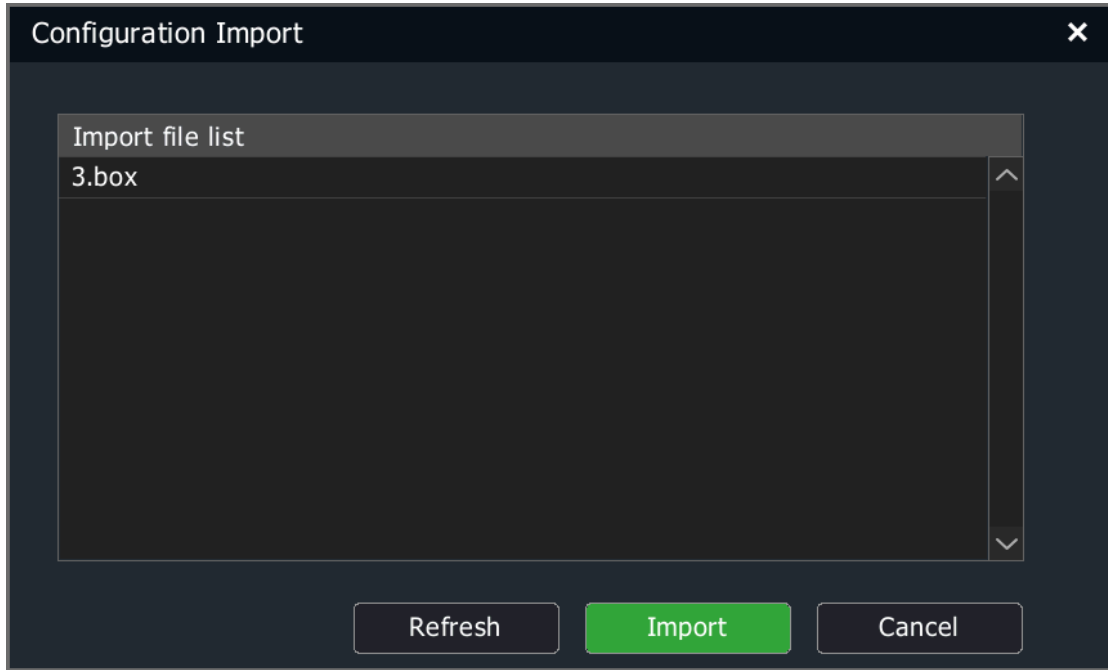

(4) Select the configuration file and click "Import" to quickly import the configuration into the front-end device.

(5) Export the front-end configuration parameters, and click " " to display the configuration export interface, as shown in the figure below.

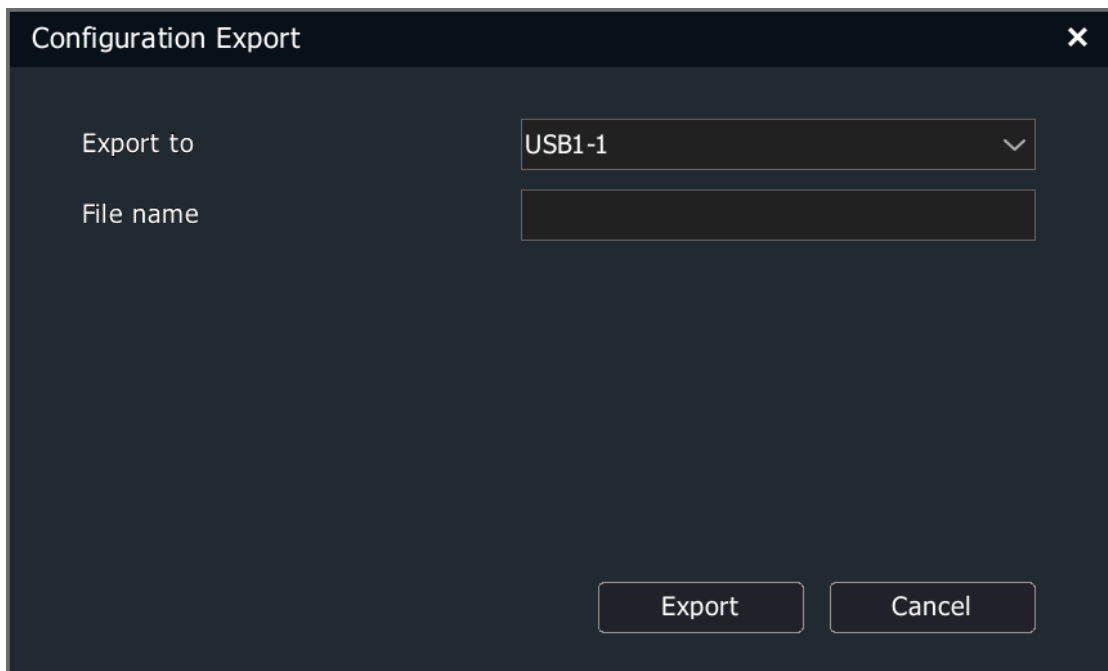

(6) Select the storage device, fill in the name of the export file and click "Export" to export the front-end configuration. The prompt form pops up after export is successful, as shown in the figure below.

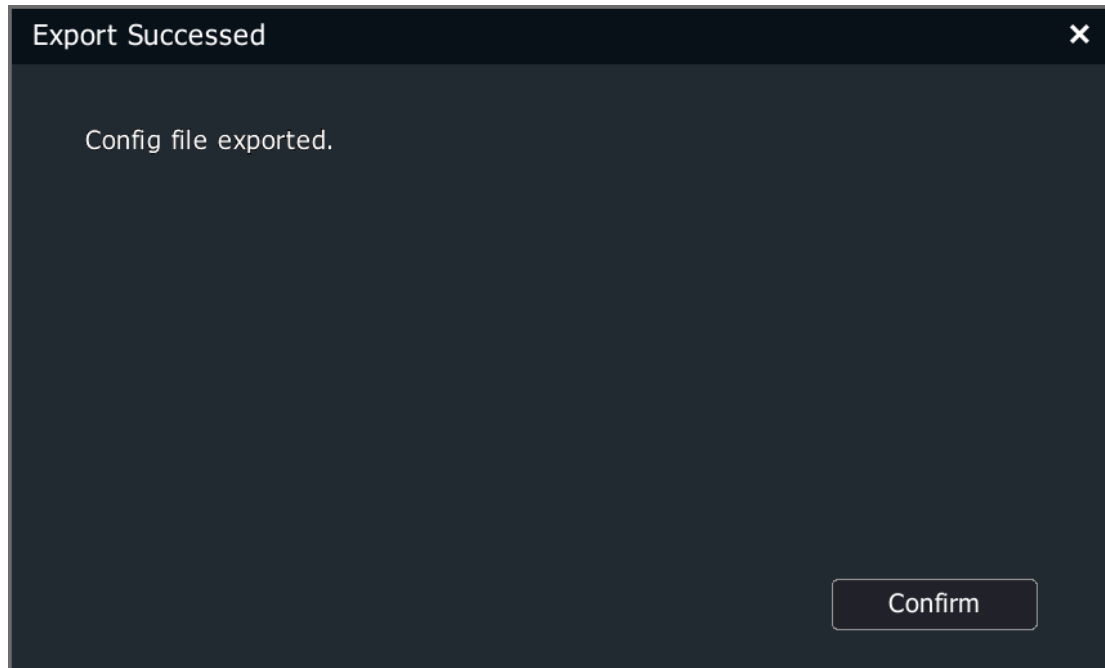

### 3. Remote Upgrade and IPC Restart

(1) Select the channel to upgrade or restart from the added device list.

(2) Click "" to display the IPC Upgrade interface, as shown in the figure below.

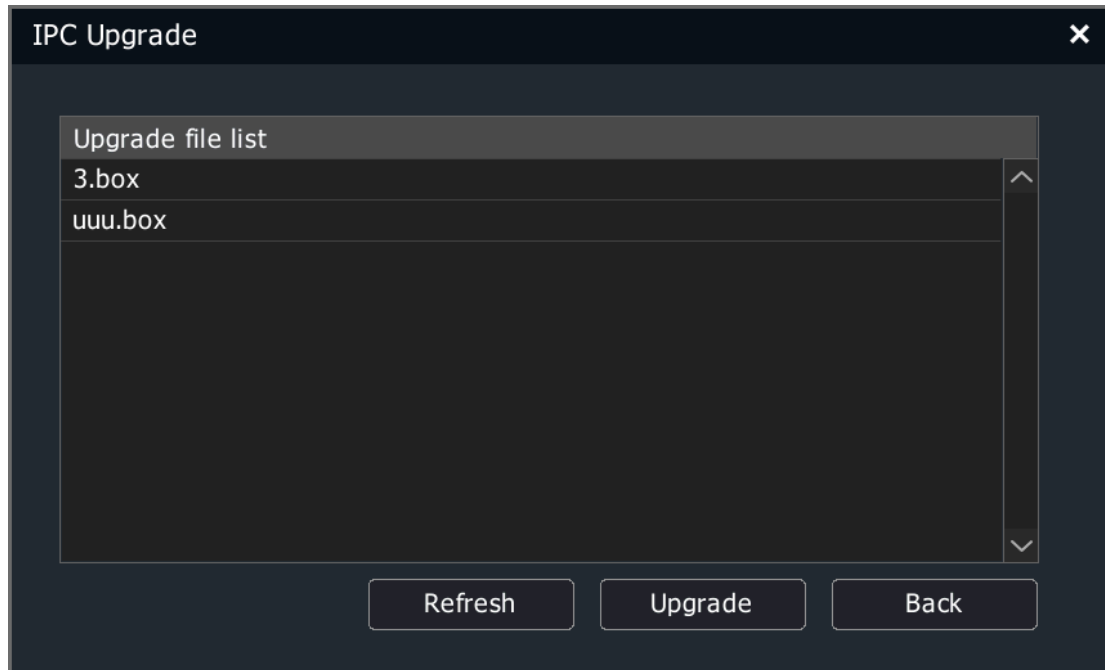

(3) Select the configuration file to upgrade, and click "Upgrade" to complete the IPC upgrade.

(4) Click "  " to remotely restart the selected device.

(5) Click "  " to display the Restore Defaults prompt box, as shown in the figure below.

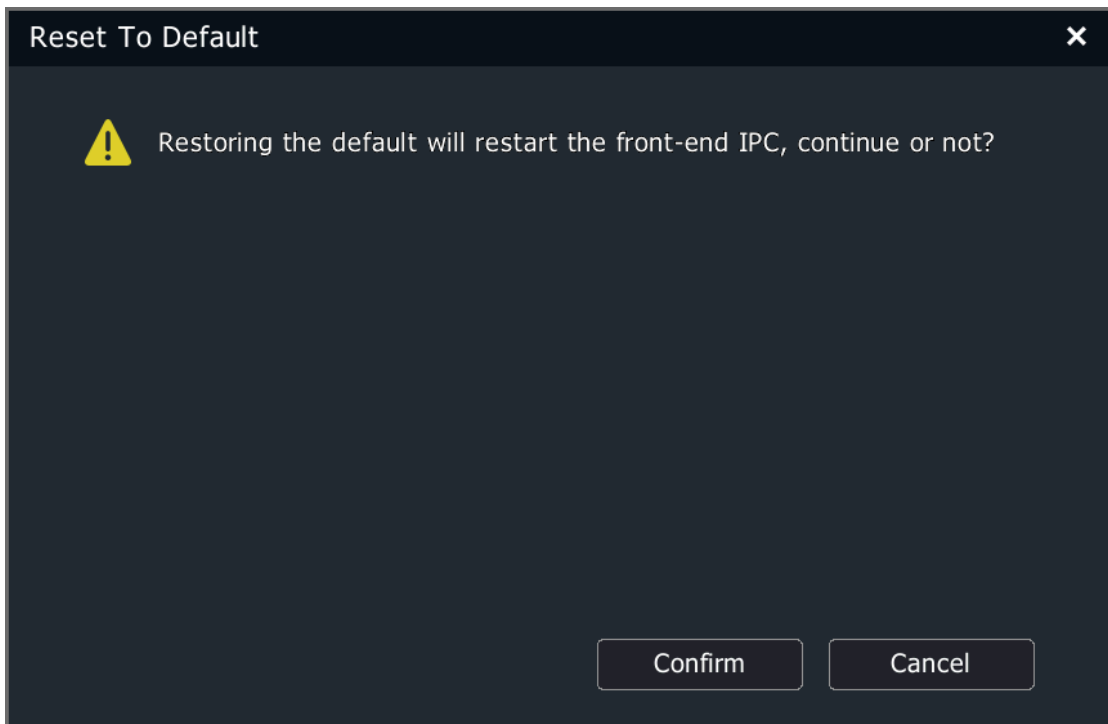

(6) Clicking "OK" and selecting IPC will restore defaults and restart IPC.

(7) Click "" to display the Cloud Update prompt box, as shown in the picture below.

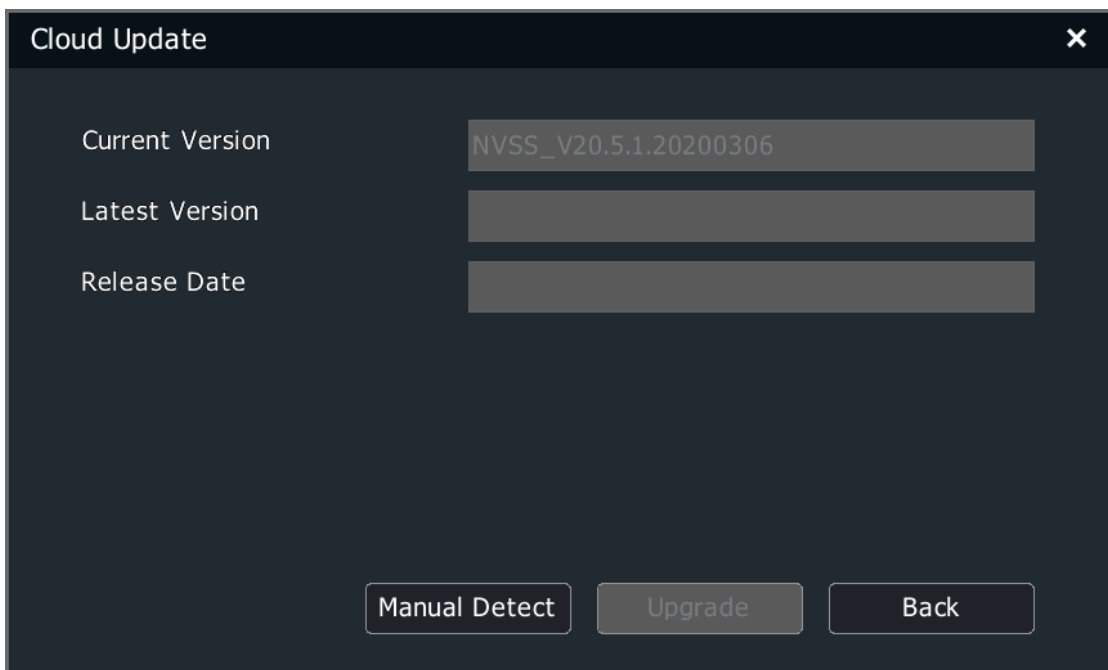

#### 4. Import Broadcast/Start Broadcast

(1) Click Import Broadcast to display the IPC Upgrade interface, as shown in the figure below.

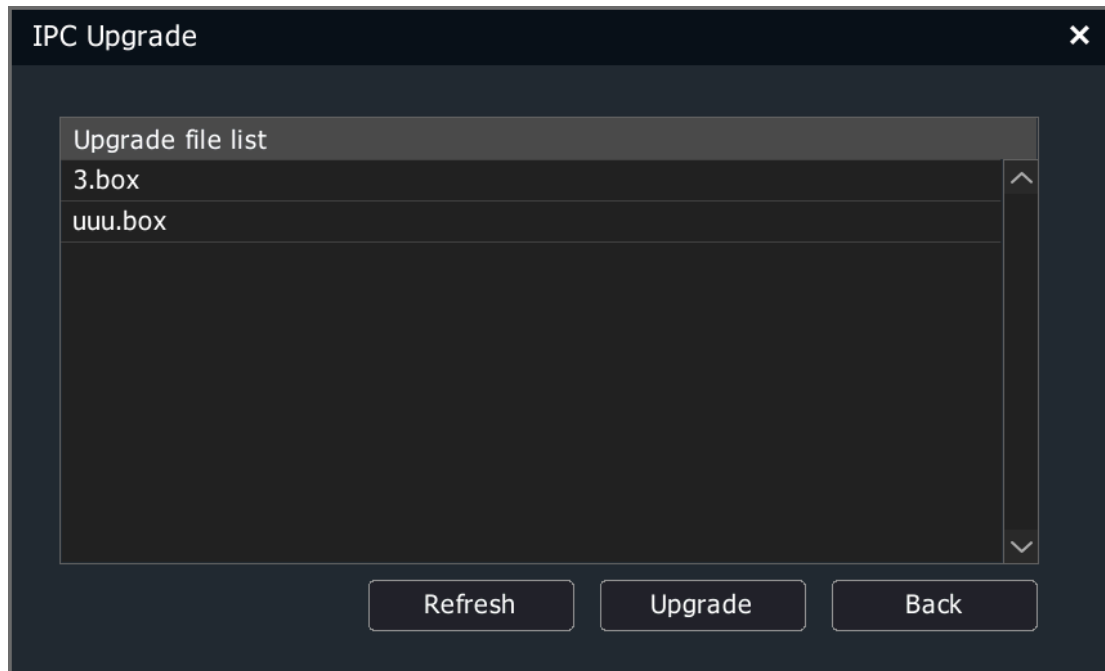

(2) Select the configuration file to upgrade, and click "Upgrade" to complete the IPC upgrade.

(3) After the upgrade is completed, click the Start Broadcast button to the Start Broadcast prompt box, as shown in the figure below.

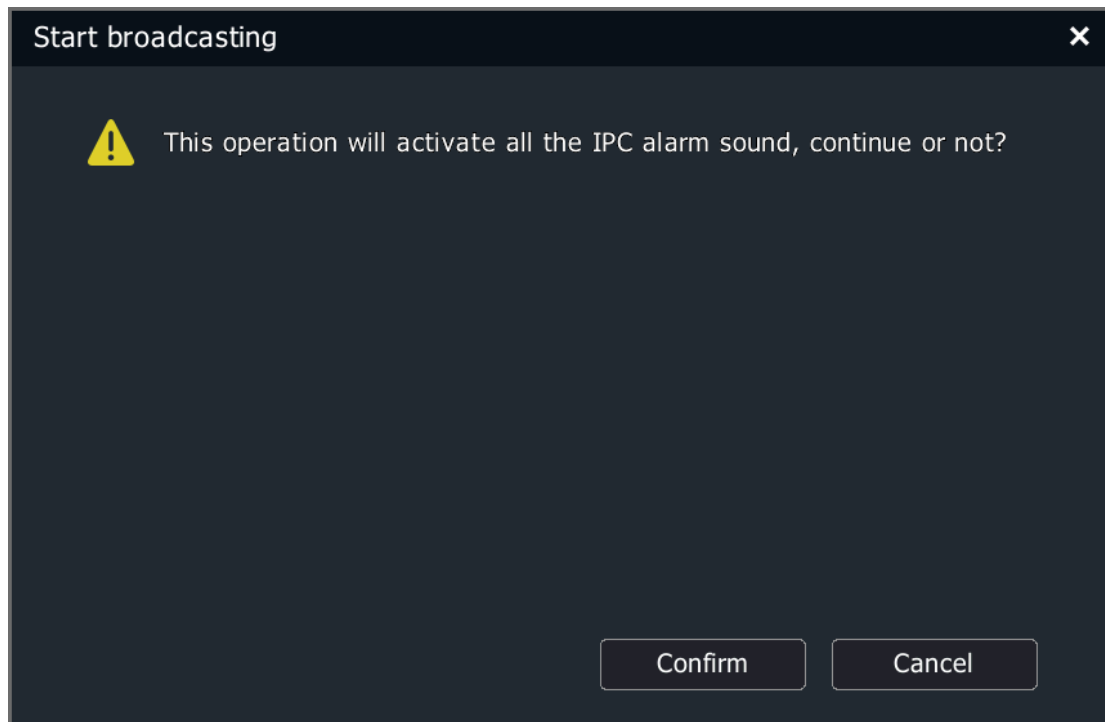

(4) Click OK, and all IPCs will begin to play the imported audio.



#### 4.4.7 POE Power Information

**This function is available in the PSE series NVRs while unavailable in other models.**

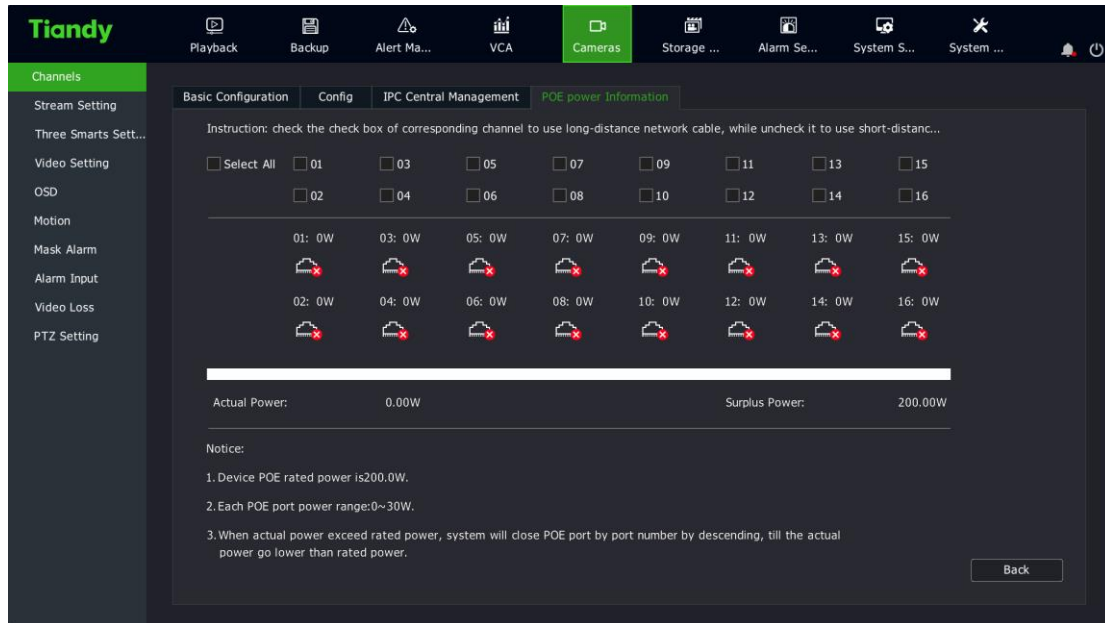
1. Select "Main Menu -> Cameras -> Channels -> POE Power Information" to enter the POE power information display interface, as shown in the figure below.



 **Note:**

- "" means that the POE port is normally powered, and "" means that the port is not connected to a camera or powered normally.
- Above the "" port is the real time power information of the POE port.

Please refer to the interface for POE power notes.

#### 4.4.8 Code Setting

Select "Main Menu -> Cameras -> Stream Setting" to enter the code setting interface, as shown in the figure below.



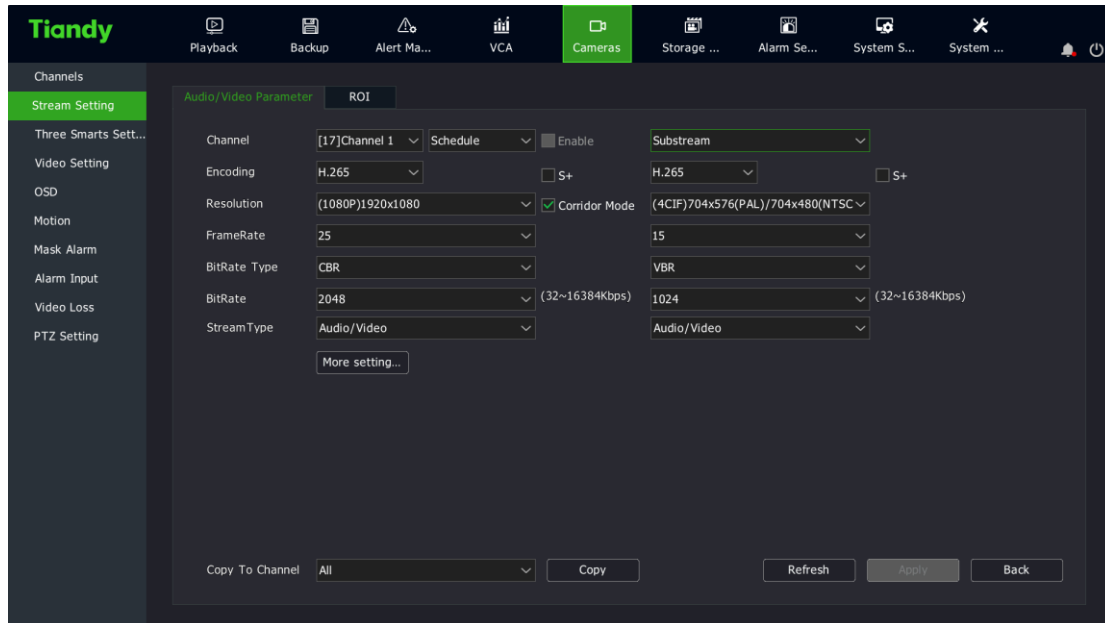

## Audio/Video Parameter

Select the channel to set and set audio and video parameters:

- Channel: select the channel where you want to set parameters.  
There are four types of video compression parameters: main stream (normal), main stream (alarm), custom 1, and custom 2.
- Encoding: The system supports H.264 and H.265 encoding, and high profile, main profile and baseline encoding methods are available.
- S+: S+ will display and distinguish the main and secondary streams according to whether it is supported by the front end. After S+ is turned on, compression mode, video quality, I frame rate and key areas will not be available. Some front ends also

support mutual exclusion of S+ and intelligent analysis. When S+ is turned on, the intelligent analysis will be turned off.

- Resolution: Sets the resolution of the front-end device.
- Corridor Mode: Enables the corridor mode when resolution is 16:9 (for example, 1080P). When corridor mode is enabled, the resolution of the video is adjusted to 9:16.
- FrameRate: Video frame rate refers to the number of video frames per second that can be selected or edited from a drop-down list.
- BitRate Type: variable bitrate and fixed bitrate. The variable bitrate will change according to the scenario, and the fixed bitrate will be coded according to the set bitrate as far as possible.
- BitRate: Can be selected or edited from the drop-down box, range: 32-16384Kbps.
- Stream type: The composite type provides two options: "Pure Video" and "Audio Video". "Audio Video" means containing video and audio information, while "Pure Video" contains only video information.
- Click "More" to display the image quality, I frame rate, audio encoding, audio control type, and input volume setting options.

- Quality: 5 options including best, better, good, average, poor. Image quality is proportional to the bitrate. The better the image quality is, the higher the bitrate is.
- I-Frame Interval: I frame, also known as key frame, One I frame is contained in several video frames. If I frame rate is 100, there is one I frame in every 100 frames of video. I frame rate inversely proportional to the bitrate. The higher the I frame rate is, the smaller the bit rate is. It is recommended that the I frame rate be the same as frame rate.
- Audio: The system provides 3 audio encoding modes: ADPCM\_D(ADPCM\_DIV4), G.711A and G.711U. Three audio sampling rates of 8K, 32K and 48K are also provided.
- Audio Type: Audio control type used by the front end: LinIn and MicIn.
- Input volume: The input volume of the corresponding channel, ranging from 0 to 100.
- Audio output type: Laser-enabled devices also support the selection of audio output type, including built-in speaker, external audio source and off. When a built-in speaker is selected, you can adjust the output volume.

- The secondary stream can be set separately. For setting methods, refer to the main stream.



#### **Notes:**

- When bitrate type is selected as "fixed bitrate", the image quality is unavailable.
- Secondary stream parameters are used for network transmission. When the network environment is not very good, users can use the secondary stream for preview and storage to reduce the bandwidth. In addition, the secondary stream is also suitable for mobile monitoring.
- For corridor mode, this should be supported by the front-end IPC.
- Coding parameter templates vary with different front-end IPCs.
- Click the More button to display or hide the setting options under the button.

#### **ROI**

The focus area can be set here after a front-end that supports it is connected. The image displayed in the focus area is of higher quality.

1、 Select the property page of the focus area, as shown in the figure below.

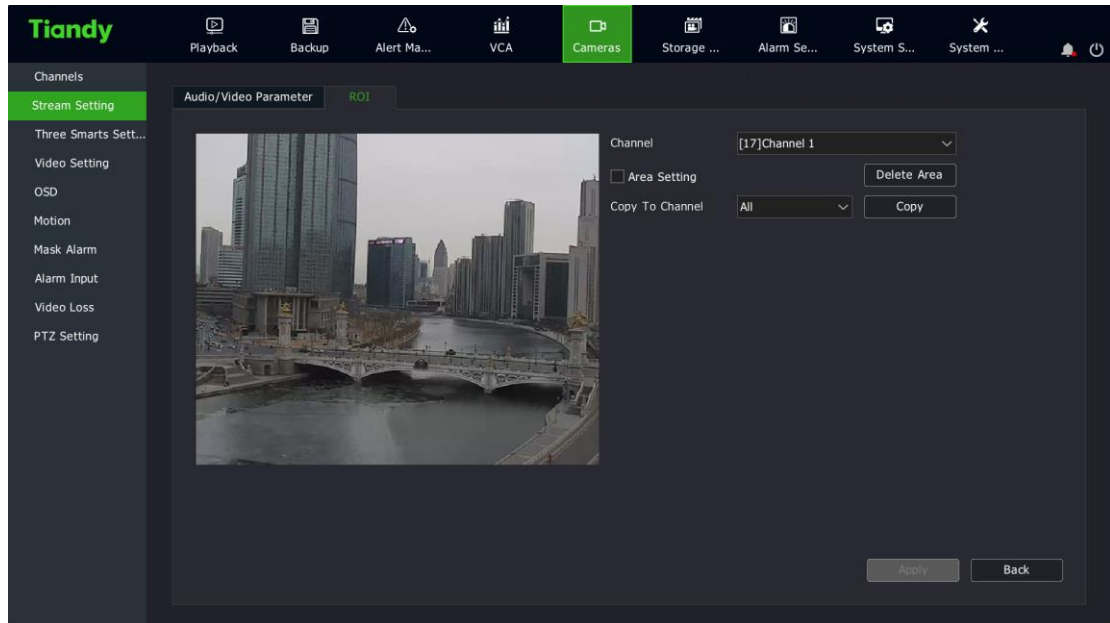

2. Check "Area Setting" to enable this function. Press and hold the left mouse button and drag over the video to set the focus area. Up to four focus areas are supported. Click "Delete Area" to delete all the focus areas that have been set.

3. Click "Apply" to save the settings.

#### 4.4.9 Video Setting

In order to obtain a good visual effect, users can adjust video parameters of the front-end according to the scenario, and the adjusted parameters will apply to local preview, video recording, network preview, etc.

Select "Main Menu -> Cameras -> Video Setting" to enter the HD parameters interface, as shown in the figure below.

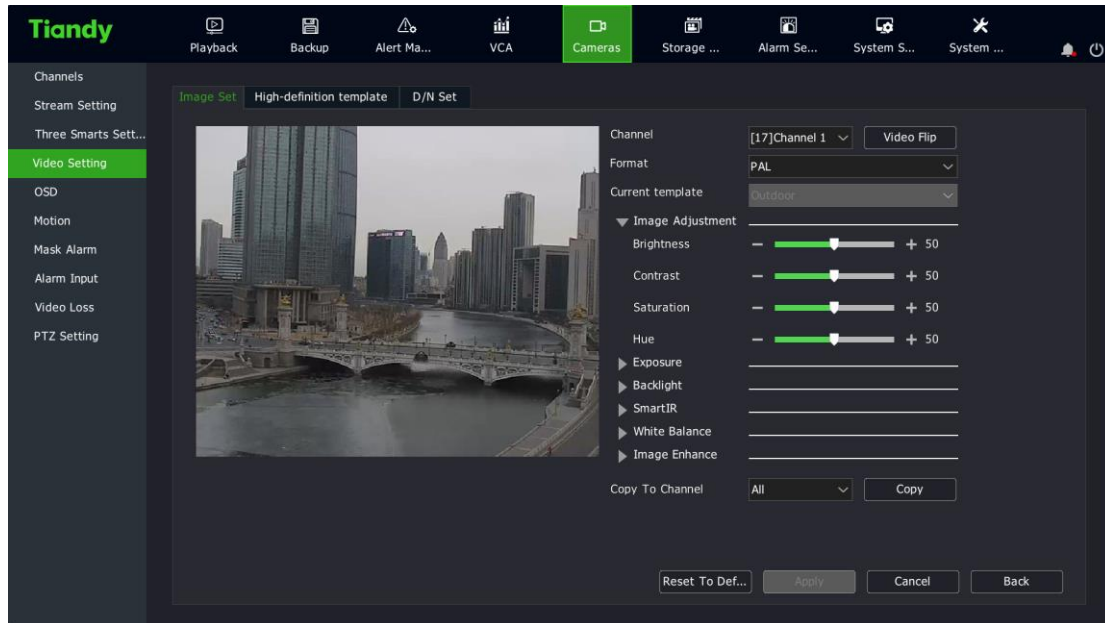

## HD parameters



1. Select the channel to set.
2. Set system, video rotation, mode and other parameters.



### Notes:

- Brightness, contrast, saturation and chroma can be adjusted between 0-100.
- The shutter speed is adjustable between 1/100000 – 1. The higher the set value is, the faster the response is.
- Auto gain is adjustable between 0 and 100.

- Ultra-wide tendency policy has three options: Off, Auto and Manual. The ultra wide tendency rating is displayed when the Ultra wide tendency policy is not turned off, and the value is adjustable between 0 and 100.
- Image enhancement includes image style, indoor and outdoor modes, digital noise reduction and noise reduction level. Image style includes adaptive, natural, bright, soft and sharp; Indoor and outdoor modes include indoor and outdoor; Digital noise reduction has three options: Off, Normal and Expert. When the normal mode is selected, the noise reduction level option is displayed, and the value is adjustable from 0 to 100. When the expert mode is selected, there will be the space-domain noise reduction level and the time-domain noise reduction level options, and the value is adjustable from 0 to 100.
- White balance has options including automatic, semi-automatic, sunny day, fluorescent lamp, warm light, incandescent lamp, natural light, lock and manual. Manual and semi-automatic can be the value between 0 and 50.
- The Copy to Channel function can be used to copy the set parameters.

- Use the mouse wheel to adjust video input parameters, or you can also click  and  icons to increase or decrease the value.

3. After setting, click "apply" to save setting parameters.

4. Restore Defaults is to allow the camera directly to restore the defaults of all parameters on this page.

### High-definition template

- 1、 Select the channel for the HD template you want to set.
- 2、 HD templates are divided into indoor, outdoor, sports, wide tendency, low light, high light, bright, custom, as shown in the figure below.

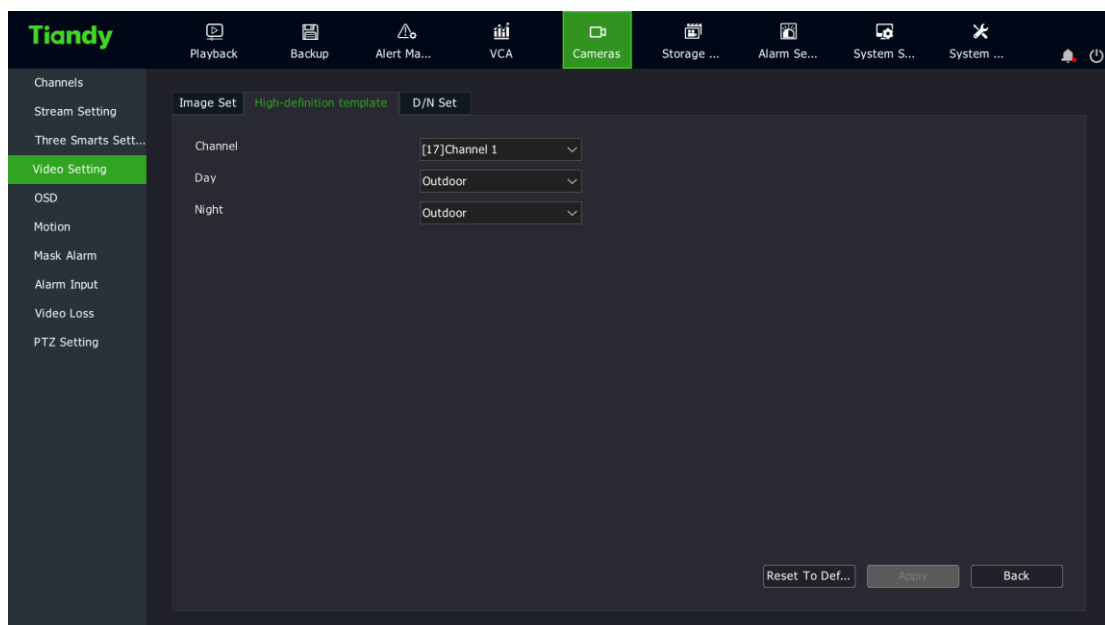



## D/N Set

- 1、 Select the channel where you want to set Color to Black.
- 2、 Color to Black types are divided into color, black and white, timer, inter-sync, exter-sync, day and night and adaptive.
- 3、 Timer is shown in the figure below.

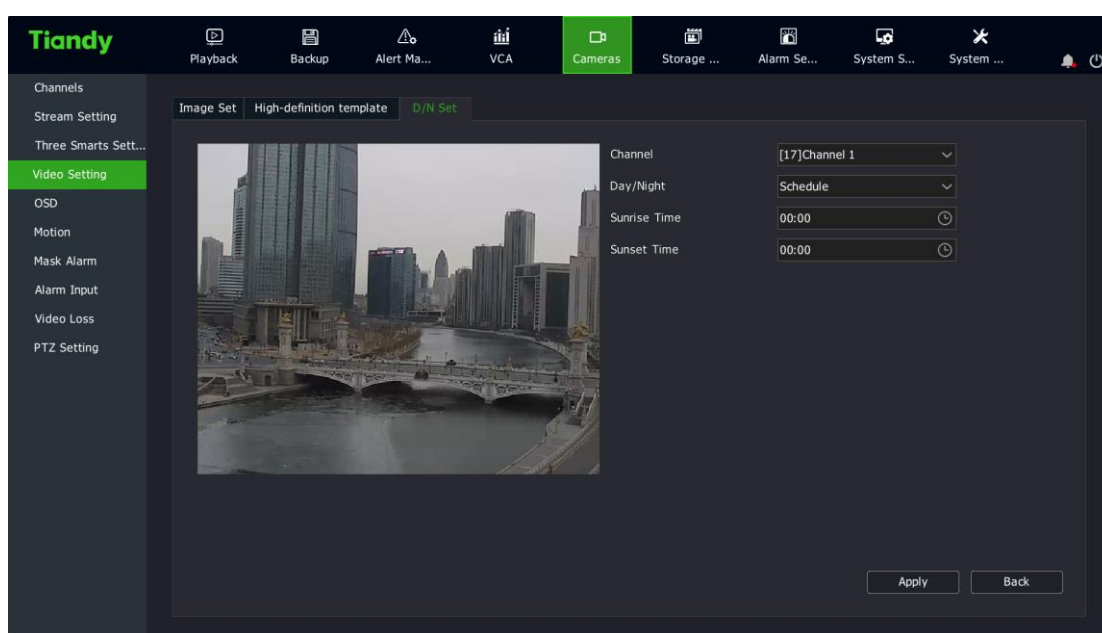



### Notes:

- Daylight hours and dark hours can be set to a time range of 00:00-23:59, and the dark hours must be later than dawn time.
- The Color to Black mode depends on the front end.

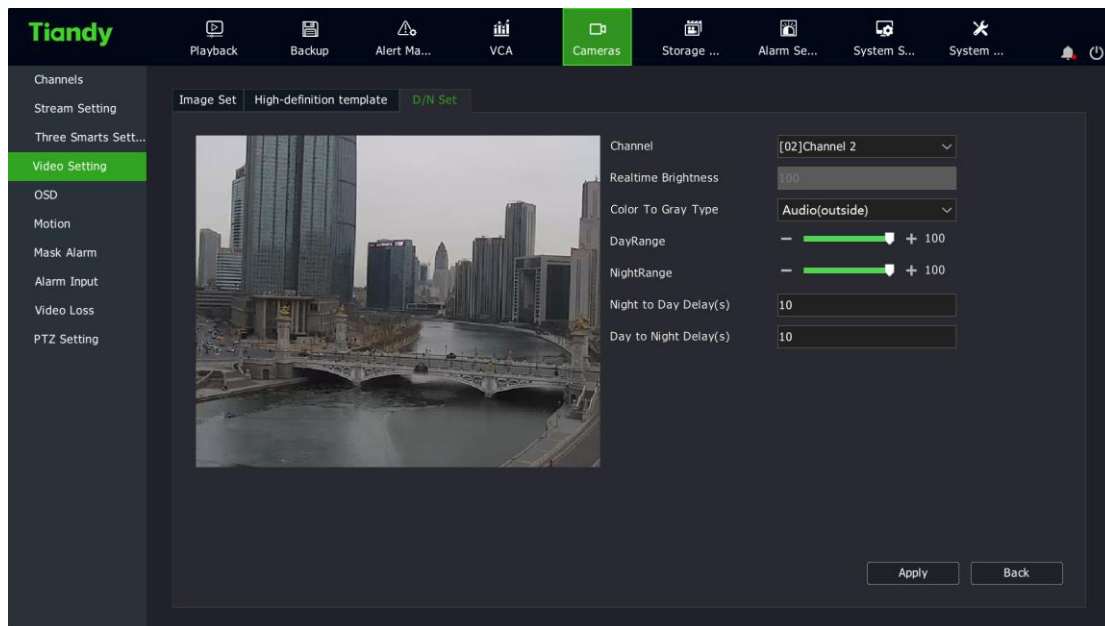
- 4、 Exter-sync is shown in the figure below.





### Notes:

- Daytime and night brightness values can be adjusted from 0 to 100, or you can click the  and  icons to increase or decrease the value. 
- The Color to Black delay and Black to Color delay can be adjusted between 0 and 120s.

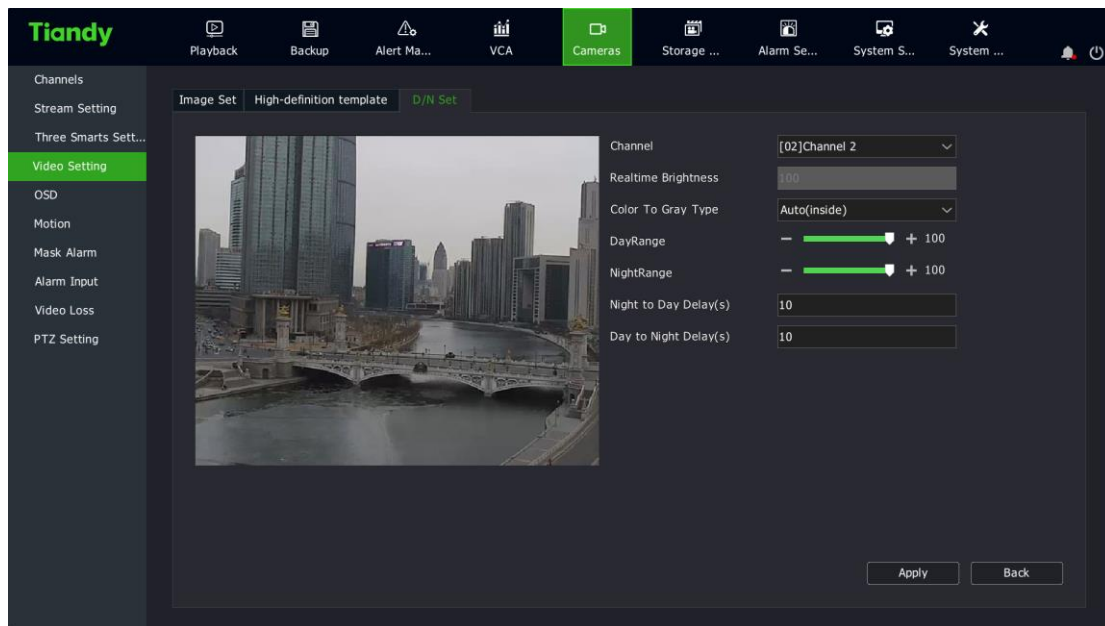
5、 Inter-sync is shown in the figure below.



### Notes:

- Daytime and night brightness values can be adjusted from 0 to 100, or you can click the  or  icon to increase or decrease the value.
- The Color to Black delay and Black to Color delay can be adjusted between 0 and 120s.

6、The day and night mode is shown in the figure below.

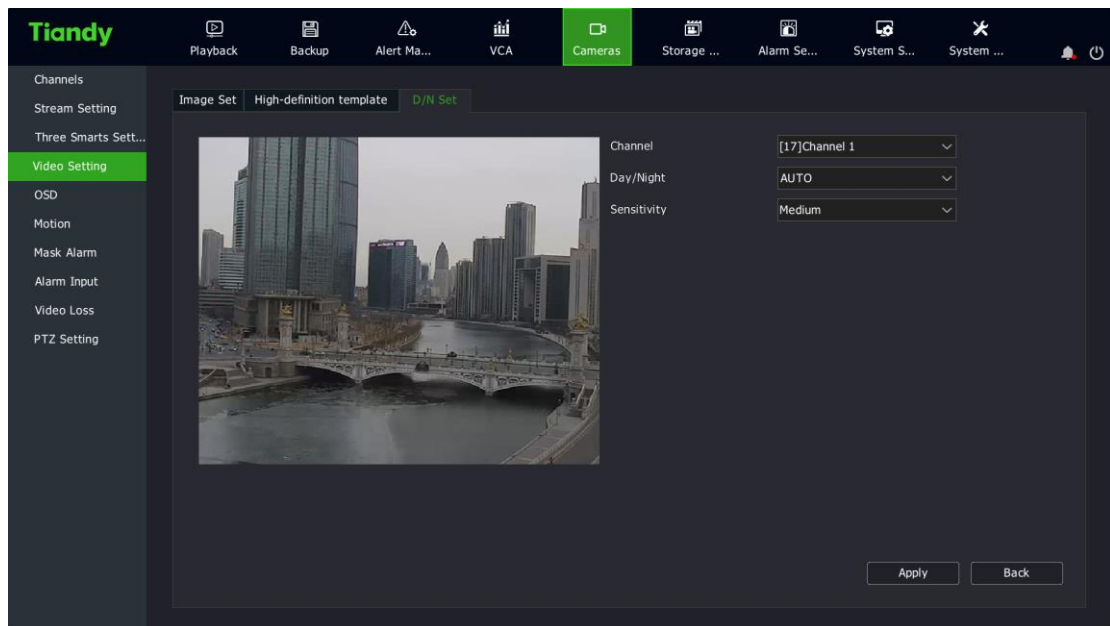

## Notes:

- The day and night mode includes automatic, daytime and nighttime.
- The sensitivity is divided into high, medium and low.

7. The adaptive mode is shown in the figure below

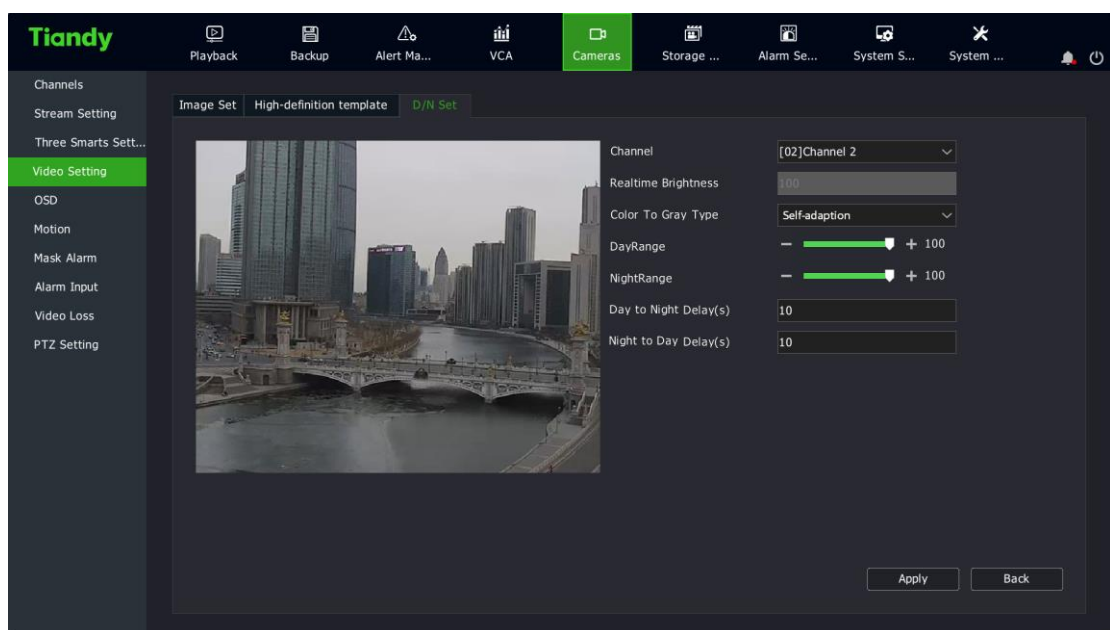

 **Note:**

- Day/night brightness values can be adjusted from 1 to 100.
- The effective delay time for Color to Black/Black to Color is 0-120 seconds.

#### 4.4.10. OSD

1. Select "Main Menu ->Cameras ->OSD " to enter the OSD overlay parameter setting interface, as shown in the figure below.

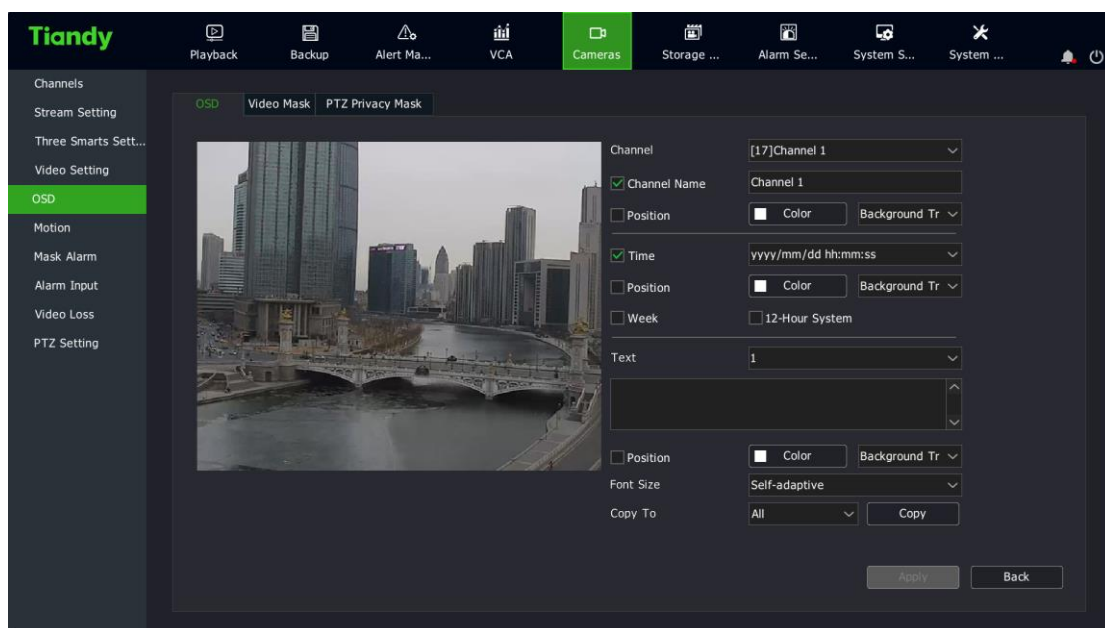

### OSD Overlay

1. Select the channel to be set OSD.
2. Set OSD for the channel.

To change the OSD position of the channel, check the custom position, and directly drag the mouse OSD box to set it.

### Notes:

- OSD overlay includes channel name, date, week day, 12-hour system, date format, time format, OSD color, background color, etc.

## Video Occlusion

The video occlusion function can occlude some key areas on the video.

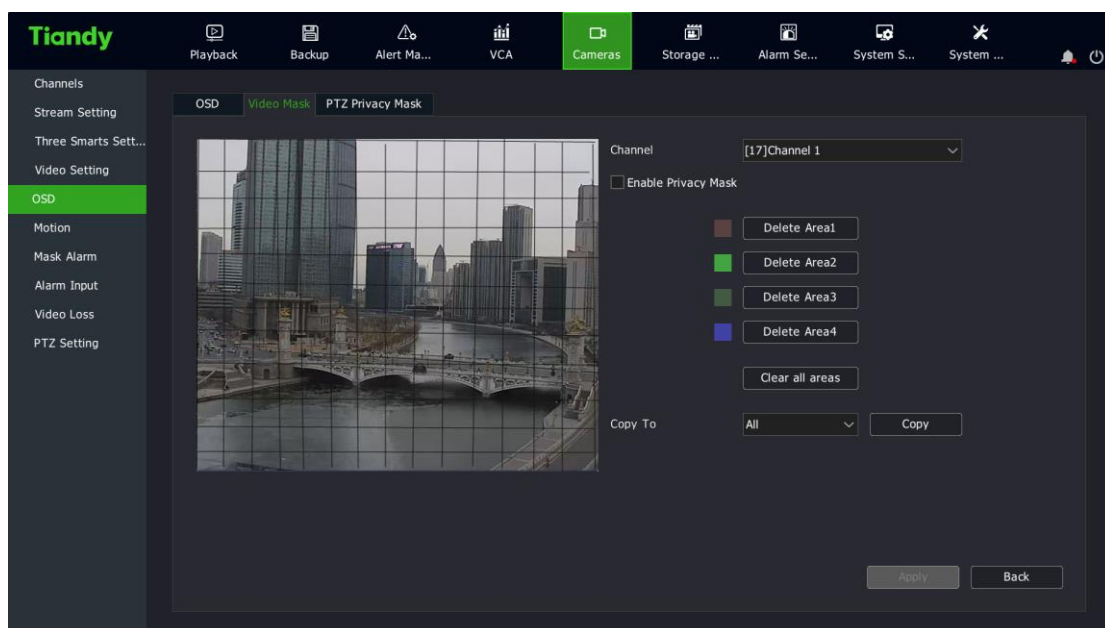

1. Select the channel to set video occlusion.
2. Drag the mouse to set the video occlusion area.

## PTZ Privacy Mask

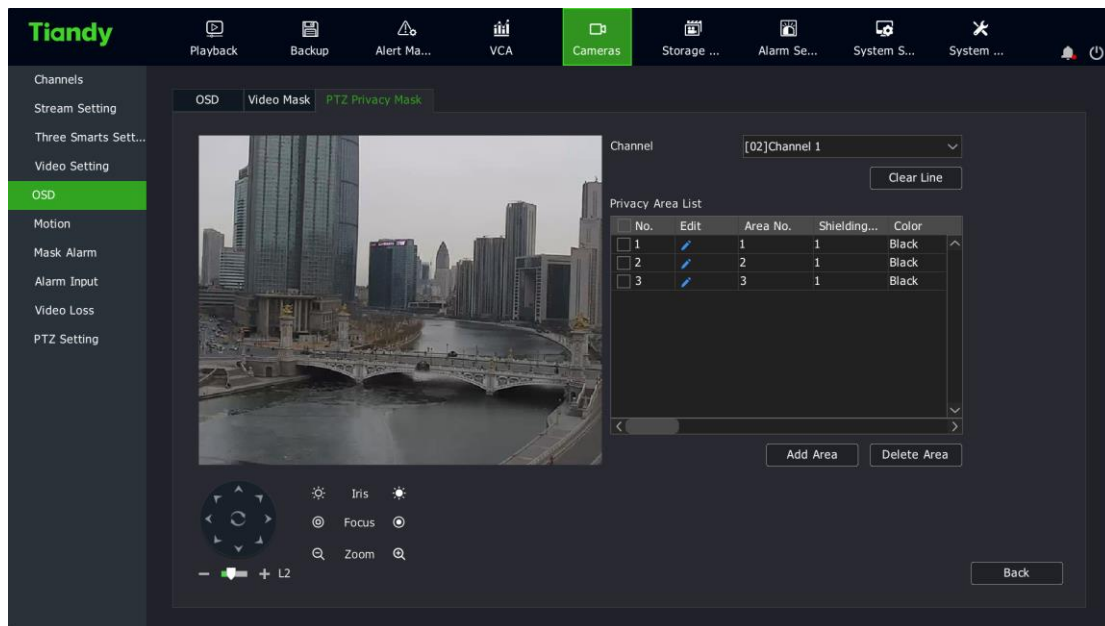

1. Select the channel to set dynamic privacy occlusion.
2. Control the PTZ via the shortcut PTZ control panel to switch to the screen you want to occlude.
3. Drag the mouse to set the video occlusion area and click "Add Area".
4. The added area is shown in the list on the right. Click "Delete Area" to delete areas.



**Note:**

- This section applies to a front-end IPC that supports this functionality.

## 4.4.11 Motion

1. Select "Main Menu -> Cameras-> Motion" to enter the motion detection setting interface, as shown in the figure below.

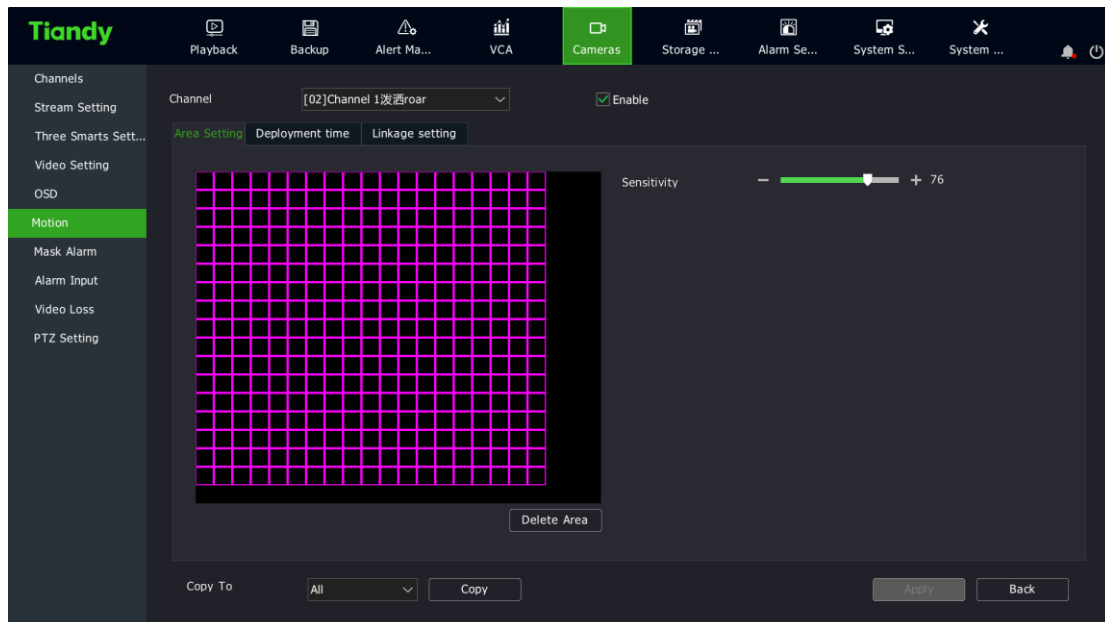

2. Select the channel to set motion detection.

3. Set the motion detection arming time, detection area and sensitivity, as follows:

(1) Check "Enable".

(2) Enter the "Deployment Time" to set the motion detection arming time.

(3) Draw the area to be detected on the video of the channel with the mouse.



(4) Adjust the sensitivity on the sensitivity slider. The higher the sensitivity value is, the more sensitive the motion detection is.

4. Enter the "Linkage Setting" to set the motion detection and alarm linkage.

(1) Alarm linkage voice prompt, screen display, sending email, linkage video, linkage output, linkage snapshot, linkage text preplan, linkage single screen and linkage double light are available for setting.

(2) After setting, parameters of other channels can be copied.

5. Click "Apply" to save the settings parameters.



**Note:**

- Double lights can be linked after front end devices supporting double lights are connected.

#### 4.4.12. Mask Alarm

1. Select "Main Menu -> Cameras -> Mask Alarm" to enter the occlusion alarm interface, as shown in the figure below.

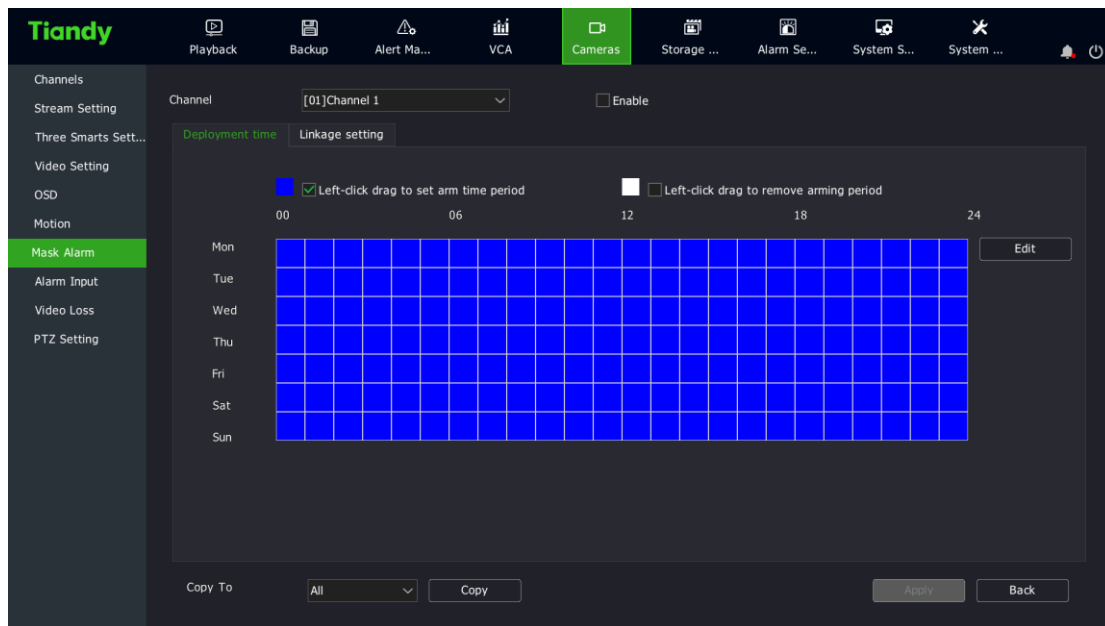

- 2、 Select the channel to set video occlusion.
- 3、 Check "Handle Video Occlusion" to process the occlusion alarm.
- 4、 Select "Linkage Setting". When an alarm occurs, you can link voice prompt, screen display, sending email, linkage video, linkage output, linkage snapshot, linkage text preplan, and linkage single screen, etc.
- 5、 After setting, you can copy the parameters from other channels. Click "Apply" to save the set parameters.

#### 4.4.13 Alarm Input

By setting alarm inputs, when input alarm occurs in the front-end IPC, the NVR device can be linked to provide prompt, video, etc.

1. Select "Main Menu ->Cameras -> Alarm Input" to enter the alarm input setting interface, as shown in the figure below.

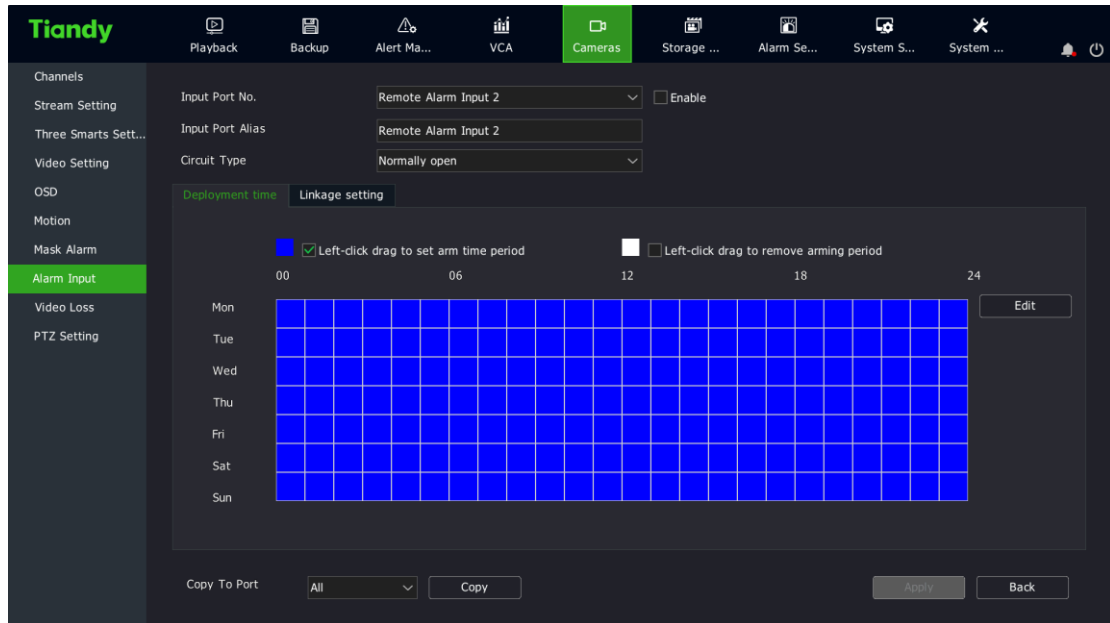

2. Select the input port number to set.

3. Select Annunciator Type.



**Note:**

- Normally-open alarm: active when the alarm input port for the front-end IPC is closed.
- Normally-closed alarm: active when the alarm input port for the front-end IPC is open.

4. Check "Handle Alarm Input" to set the arming time of alarm input.

5. Enter "Linkage Setting" to set alarm linkage.

(1) Options include alarm linkage voice prompt, screen display, sending email, linkage video, linkage output, linkage snapshot, linkage PTZ, linkage text preplan, linkage single screen, etc.

(2) After setting, parameters of other channels can be copied.

6. Click "Apply" to save the settings.

#### 4.4.14 Video Loss

Set the video loss alarm. When video loss occurs in a channel, it is linked to the NVR device for prompt, recording, etc.

1. Select "Main Menu -> Cameras -> Video Loss" to enter the video loss setting interface, as shown in the figure below.

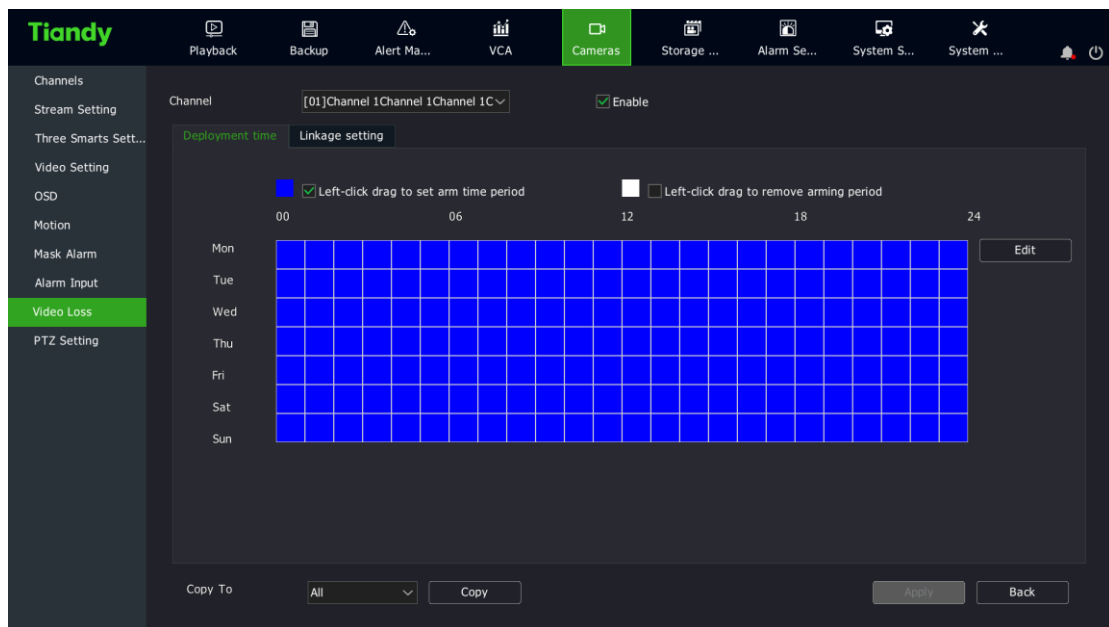

2. Select the channel to set video loss.

3. Check "Handle Video Loss" and set the arming time for video loss.

4. Enter "Linkage Setting" to set alarm linkage.

(1) Options include alarm linkage voice prompt, screen display, sending email, linkage video, linkage output, linkage snapshot, linkage PTZ, linkage text preplan, linkage single screen, etc.

(2) After setting, parameters of other channels can be copied.

5. Click "Apply" to save the settings.

#### 4.4.15 PTZ Setting

Set the PTZ control protocol and serial port property for a channel.

1. Select "Main Menu -> Cameras -> PTZ Setting" to enter the PTZ setting interface, as shown in the figure below.

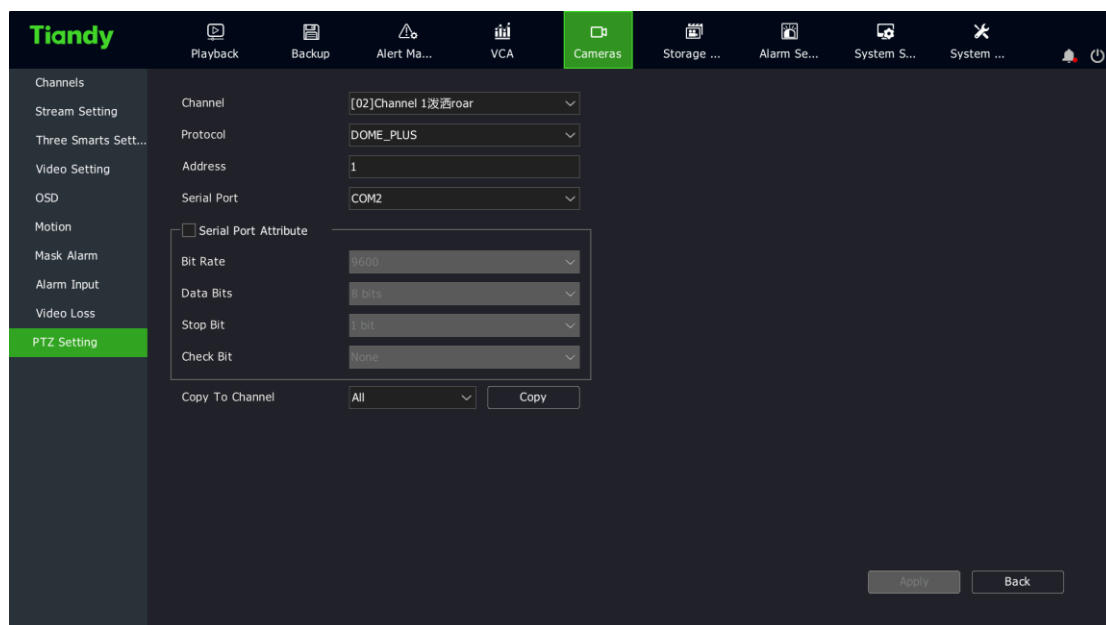

2. Select the channel to set.

3. Select the PTZ control protocol, address and serial port of the channel.

Once the setup is complete, parameters of other channels can be copied.

4. Click "Apply" to save the settings.



**Note:**

- Users can customize the serial port properties to set the baud rate, data bit, stop bit and check bit of the serial port, and choose to copy these set parameters to other channels after setting.

#### 4.4.16. Three Smarts Setting

For the three smarts camera, the intelligent three smarts setting can be used to carry out motion detection.

1. Select "Main Menu -> Cameras -> Three Smarts Setting" to enter the basic setting page, as shown in the figure below.

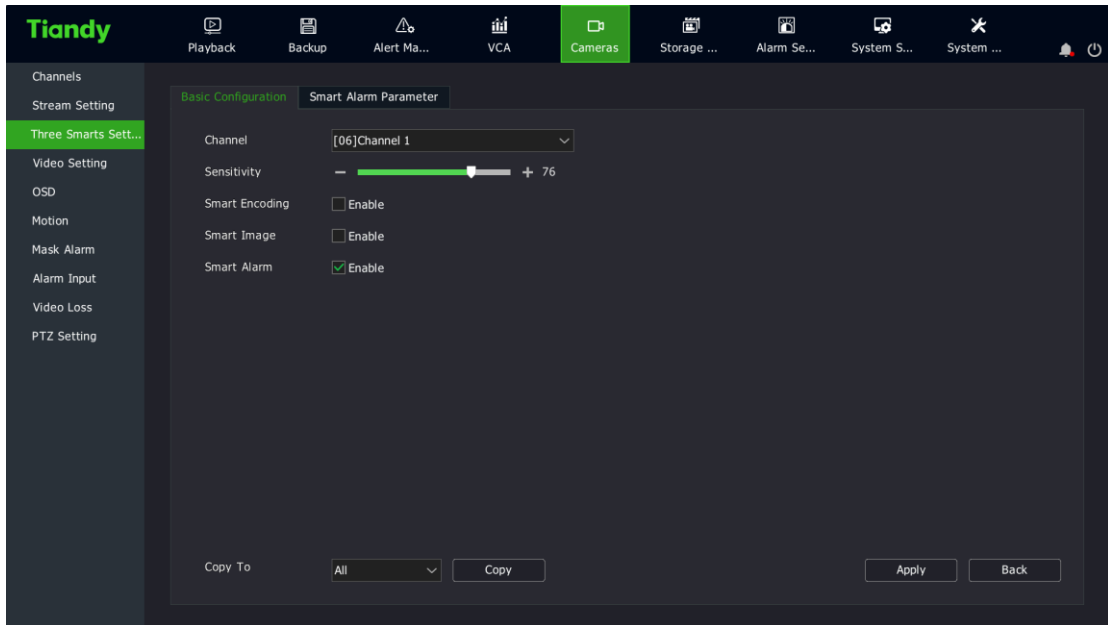

2. Select the channel to set motion detection to set the sensitivity, and select to enable intelligent coding, intelligent image and intelligent alarm. Click the Apply button.

3. Set the motion detection area, as shown in the figure below.

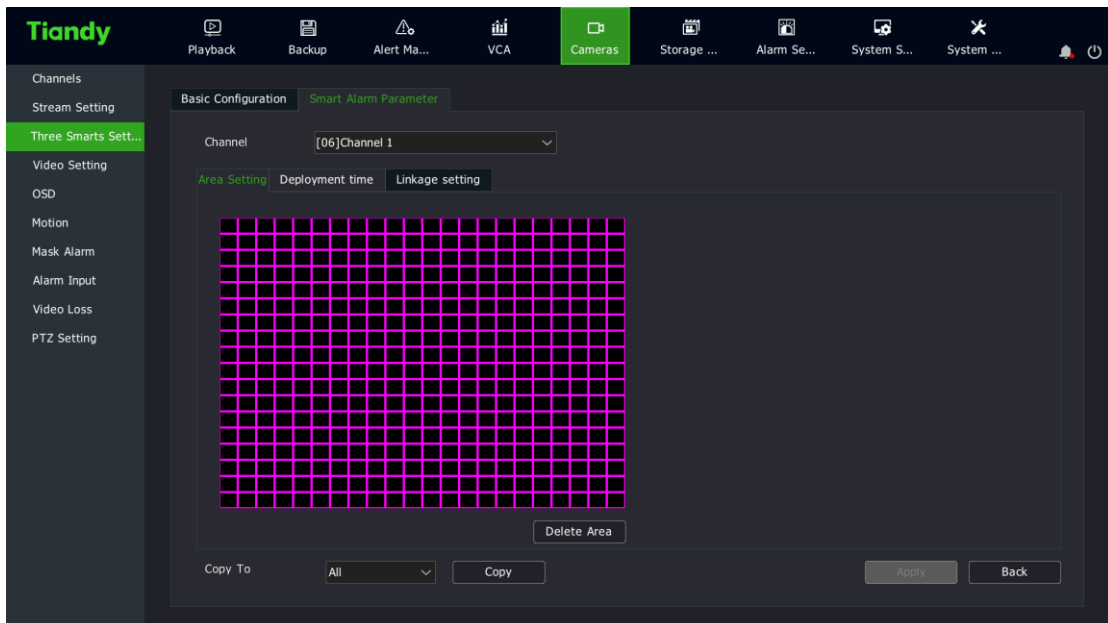

3、 Set the arming time as shown in the figure below.

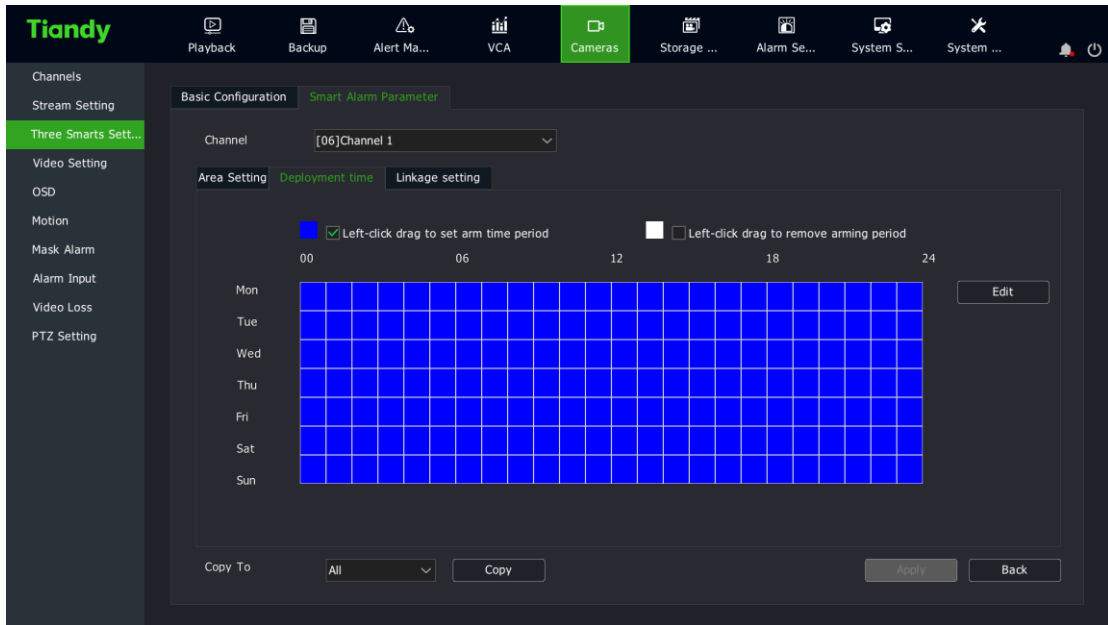

4、 Enter the "Linkage Setting" to set the motion detection alarm linkage, as shown in the figure below.

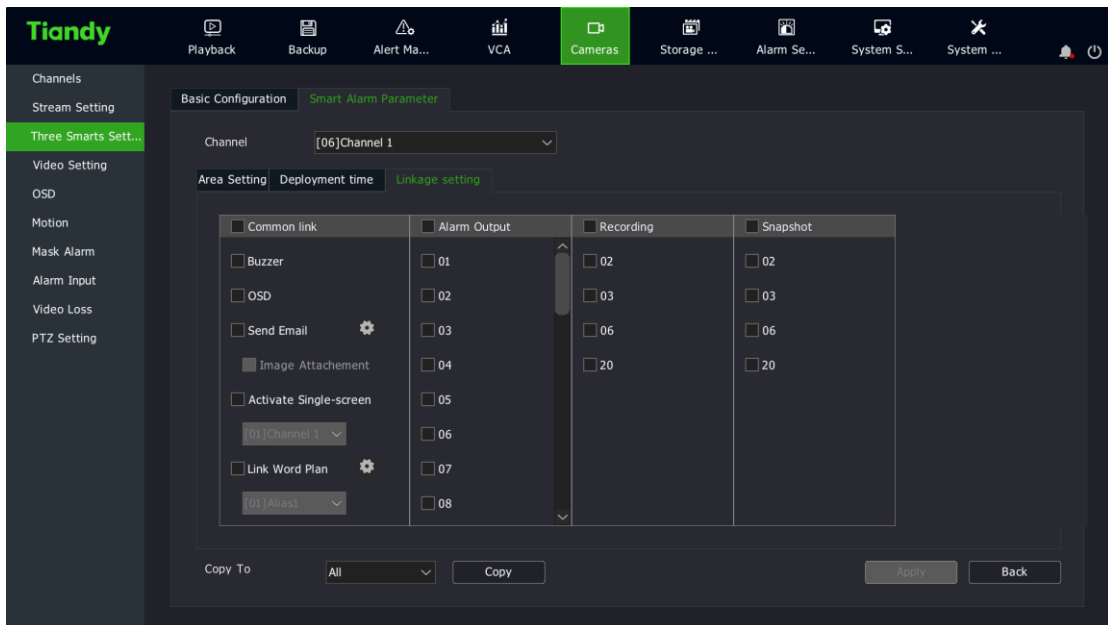

(1) Options include alarm linkage voice prompt, screen display, sending email, linkage video, linkage output, linkage snapshot, linkage text preplan, linkage single screen, etc.







(2) After setting, parameters of other channels can be copied.

5. Click "Apply" to save the settings.

## 4.5 Preview

### 4.5.1 Interface Status

On the preview interface, the video recording and alarm status of each channel can be distinguished by the icon on the upper right of each channel. For description of preview status, please refer to the table below.

Icon	Status Description
	Alarm (including motion detection alarm, video occlusion alarm, port alarm, video loss alarm, intelligent analysis alarm, etc.)
	Video recording (including timer, manual and various types of alarm linkage videos)
	Face recognition: This channel has enabled face recognition
	The channel is recording and an alarm occurs

### 4.5.2 Task Bar Menu

In preview state, the task bar allows for preview screen switch, preview setting, output mode, alarm clearing, alarm information viewing,

network setting, mobile monitoring, time setting and other operations, as shown in the figure below.



Taskbar diagram of main port



Taskbar diagram of auxiliary port

#### Descriptions of main port taskbar items

Name	Description
Main Menu	Enter the system Main Menu.
Single screen	Select a channel from the drop-down menu to switch between single screens.
Multi-screen	Change the preview mode with the drop-down menu option.
Custom preview	Directly apply the specific preview screen number and scene configuration previously set by the user. For settings, see "Preview Setting -> Custom Preview Interface Description".

Previous	Switch to the previous screen.
Next	Switch to the next screen.
Start switching	Continuously switch to the next screen according to the preview settings and start from the first screen when you reach the last screen.
Output mode	Options include standard, soft, bright, highlight.
Auxiliary port	Mouse operation changes from main port to auxiliary port.
Alarm clearing	Clear all current alarms in the system.
Alarm information	Check abnormal alarms and regular alarms.
Network setting	Enter the network setting screen. (An alarm will be generated when IP conflicts and the network disconnects)
Mobile monitoring	Download the mobile monitoring client and QR code for the connecting device.
Time setting	Enter the time setting interface

Hide/lock toolbar	Hide or lock the toolbar
Target detection	The real-time mode allows viewing of the alarm pictures of face detection and face recognition in real time. The history mode allows viewing of the alarm pictures of face detection and face recognition within one hour;



**Notes:**

- To use the “Custom Preview” action, set the “Custom Preview” configuration in the Preview Setting.
- To use “Start Switching” , set “Cruise Interval” in the Preview Setting.
- Android and IOS clients are available for mobile monitoring, and the status of public network connection can be checked.
- TC-NR1016M7-S8, TC-NR1032M7-S8, TC-NR20xxM7-S8, TC-NR20xxM7-E8, and TC-NR20xxM7-E16 are set with main and auxiliary ports, while other models have no auxiliary ports.

Description of auxiliary port right-click menu item

<b>Name</b>	<b>Description</b>
Single screen	Select a channel from the drop-down menu to switch between single screens.
Multi-screen	Change the preview mode with the drop-down menu option.
Previous	Switch to the previous screen.
Next	Switch to the next screen.
Start switching	Continuously switch to the next screen according to the preview settings and start from the first screen when you reach the last screen.
Main port	Mouse operation changes from auxiliary port to main port.
Set as main port	Set auxiliary port as main port, which means that main and auxiliary ports are exchanged.
Hide/lock toolbar	Hide or lock the toolbar

## Custom Preview

Users arrange some specific channels according to the specific number of screens on the same screen as needed. When you select a configuration from the "Custom Preview" popup menu, the preview becomes this display screen.

### **Single Screen**

Switches the current screen to a specified channel. Select a channel in the "Single Screen" pop-up menu, that is, selecting the channel for preview.

### **Multi-screen**

Modify the display mode of the output device. The system supports 1/3/4/6/8/9/10/13/16/20A/20B/25/32/36/40/64 screen preview. If the multi-screen preview is selected, the preview is done according to this number of screens.



#### **Note:**

- For TC-NR20-S series and TC-NR20-E series NVRs, except for 20-channel devices, VGA1/HDMI1 supports up to 64 screens and VGA2/HDMI2 supports up to 32 screens. The maximum number of supported screen is subject to the specific model.

### **Page UP/Down**

Click the "Previous " button on the taskbar to switch to the previous screen, and click the "Next" button to switch to the next screen.

### Start/Stop Switching

After calling out the taskbar on the main port/auxiliary port, select "Start Switching", and the main port/auxiliary port will start switching according to the set cruise sequence; Select "Stop Switching" to stop switching.











#### 4.5.3 Shortcut Preview

1. In preview state, select the channel to operate by using the left mouse button. The shortcut bar is shown below the red box, as shown in the figure below.

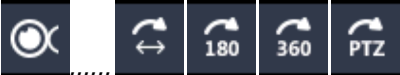

2. The shortcut menu can be used for PTZ control, instant playback, manual snapshot, digital zoom, intercom and channel information editing, etc. For specific operation, please refer to the figure below:

Button	Description
	PTZ control

	OSD overlay
	Instant playback
	Manual snapshot
	Digital zoom
	Intercom ON/OFF
	Adjust volume
	Low delay/high flow
	Set the fisheye mode supported by preview
	View/edit channel information
	View the IPC parameters
	Enable 3D positioning

## Instant Playback



Playback videos within 5 minutes of the channel. If there is no video available in the channel, the "Instant Playback Failed" message will be display.

### Digital zoom

- 1、Click  to enter the digital zoom interface, as shown in the figure below.

Original video:



Screenshot of the digital zoom effect:



- 2、 Scroll the mouse wheel to zoom in or out. The zoom-in or -out area is centered around the current position of the mouse.
- 3、 You can also click "+" in the upper left corner of the screen to zoom in and "-" to zoom out. Zoom-in and -out are done around the center of the current screen.
- 4、 When zooming in, the left mouse button can still drag and drop the image to change the zooming area.
- 5、 Click the right mouse button to exit digital zoom.

 **Note:**

- Depending on the processing capacity of the equipment, the maximum magnification time is 8 times or 16 times.

**High Flow/Low Delay:**

When High Flow is selected, the NVR devices will ensure fluency based on network traffic. When the Low Delay mode is selected, the video delay is reduced.

#### 4.5.4 Preview Parameter Setting

1. Enter "Main Menu -> System Setting -> Preview Setting", as shown in the figure below.

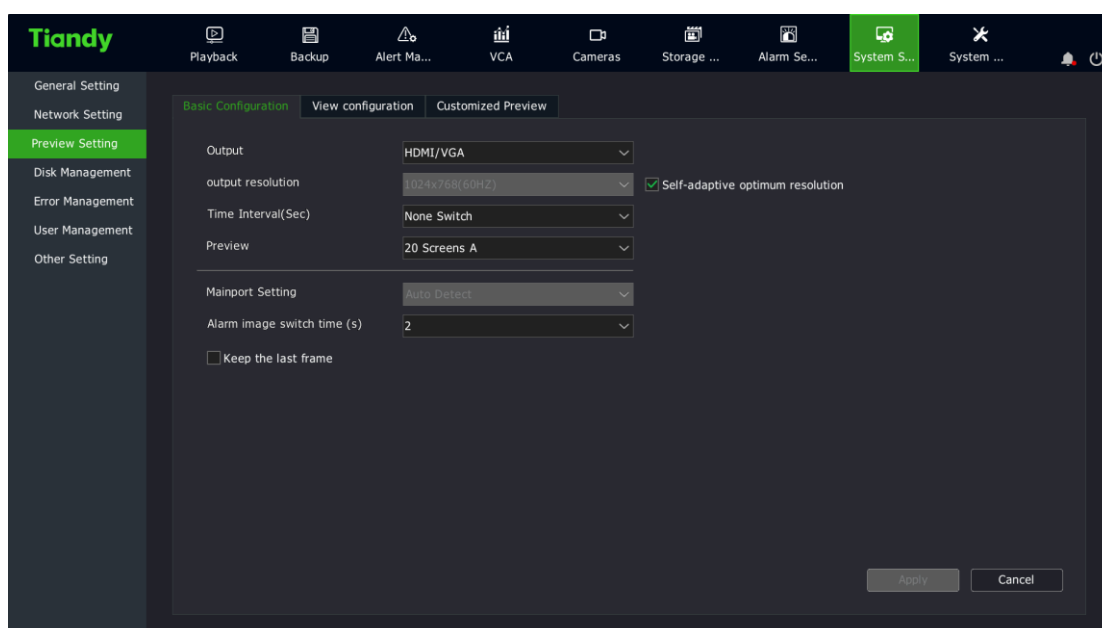

2. Description of the Preview Setting -> Basic Configuration interface:

- Output device: select a video output device from the "output device" drop-down list: HDMI2/BNC, VGA/HDMI, VC (VC is shown here when the last channel is set as the virtual composite channel).

- Output resolution: 800\*600, 1024\*768, 1366\*768, 1440\*900, 1280\*800, 1280\*720, 1920\*1080, 2560\*1440, 2560\*1600, 3840\*2160, etc. The list items may vary with devices.
- Automatic detection: Adaptive to the best resolution of the monitor.
- Cruise interval: Sets the preview automatic switching time interval. Options include no cruise, 2s, 3s, 5s, 10s, 15s, 30s and 60s.
- Preview mode: set screen number configuration, including 1, 3, 4, 6, 8, 9, 10, 13, 16, 12 A, 12 B, 25, 32, 36, 40, 64, etc. The list items may vary with devices.
- Main port setting: This setting is available in TC-NR1016M7-S8, TC-NR1032M7-S8, TC-NR20xxM7-S8, TC-NR20xxM7-E8, and TC-NR20xxM7-E16, while unavailable in other specifications.
- Output mode: Sets VGA output display effect. Options include standard, soft, bright, and highlight.
- Alarm screen switching interval: Sets the time interval of alarm linkage single screen display. Options include 2s, 3s, 5s, 10s and 15s.

- Keep the last frame: With this option configured, the preview will stay on the last frame after the front camera is disconnected. Otherwise, "No Video" is displayed.

### 3. Description of the Preview Setting -> View Configuration interface

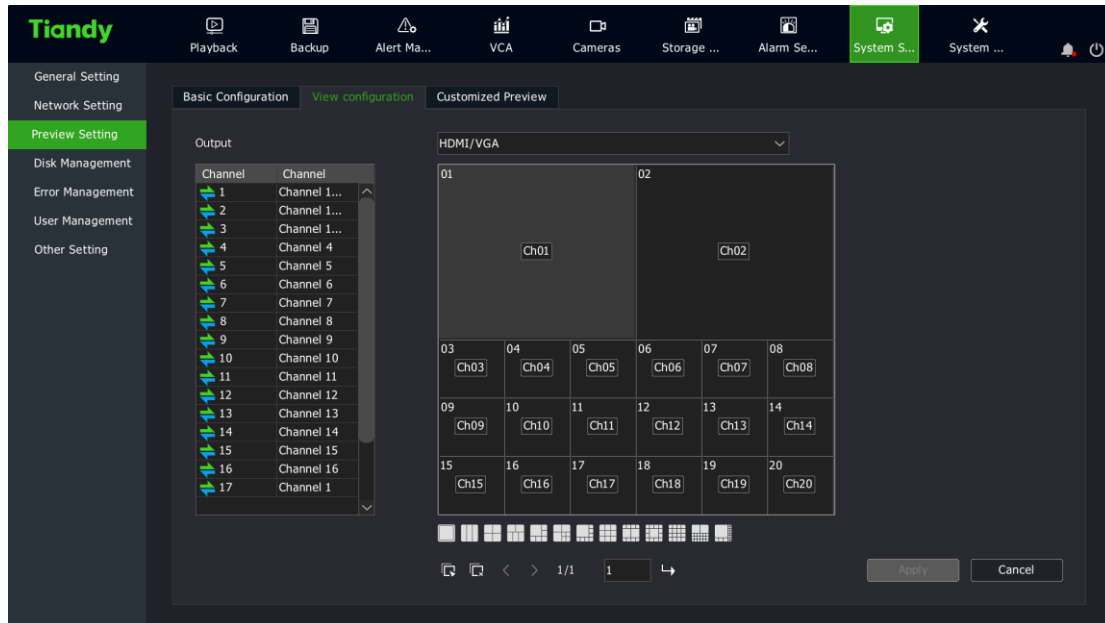

Select the screen number on the right, double-click the screen to delete the preview channel, and double-click the channel number in the table on the left to configure the channel number to the specified location. To open or close all preview channels, click Auto Configure and Clear All on the lower right.



**Notes:**

- The standard series NVRs (16-channel 8-disk position, 32-channel 8-disk position) have two kinds of output devices: HDMI2/BNC and VGA/HDMI1.
- The TC-NR20-S series and TC-NR20-E series NVRs (TC-NR20xxM7-S8, TC-NR20xxM7-E8, TC-NR20xxM7-E16) have two kinds of output devices: VGA1/HDMI1 and VGA2/HDMI2.
- The multimedia NVR series (20-channels 1-disk position) have one kind of output device: HDMI/VGA.
- When the maximum preview performance is switched from the main stream to the secondary stream, as the secondary stream is non-composite audio by default, there may be no sound in the UI preview. Due to the limitation of device performance, when the access stream reaches the upper limit of device performance, it cannot continue to connect to other streams.

#### 4. Description of the Preview Setting -> Customized Preview interface

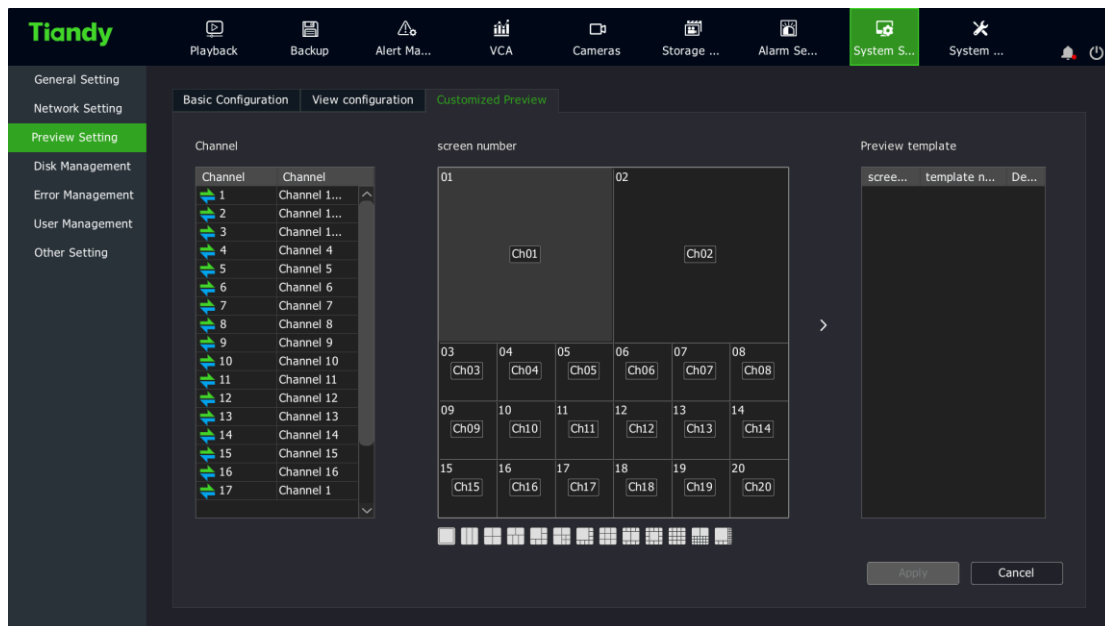

The left and middle sides of the interface are used the same way as the view configuration interface. When the channel is configured, click the arrow between middle and right to add the configuration to the preview template. The maximum number of supported templates is 8. After configuration is completed, click "Apply" in the lower right corner to make it effective. Selecting the preview template can change the channel and screen number configuration. Double-click can change the template name. Preplan application is used in the right-click menu of preview screen.



#### 4.5.5 Preview Interface Message

##### Limited Decoding Performance

When the decoding performance of the device reaches the upper limit, the device will display the message as below: "Decoding

performance reaches the upper limit, please manually disable part of channels". You can configure whether to enable the message. For details, see the System Settings -> General Settings. It is not enabled by default.

### System Exception Message:

When the options in System Settings -> Route Maintenance -> Network Exception/Storage Exception are enabled and related exception events occur, the  icon in the upper right corner of the screen will become the  icon. Double-click on the icon will open the system notification interface, as shown in the figure below.

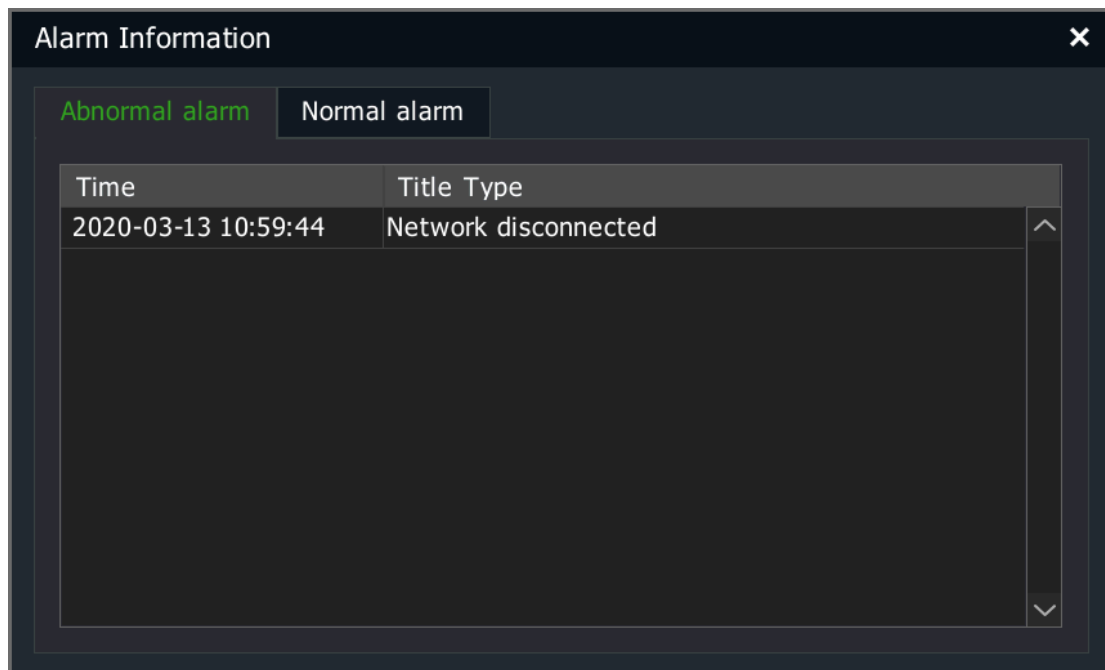



Alarm Information		
Abnormal alarm		
Normal alarm		
Time	Title Type	Content
2020-03-13 10:53:39	VCA	[03]Channel 1Channel 1Ch...
2020-03-13 10:53:36	VCA	[03]Channel 1Channel 1Ch...
2020-03-13 10:53:34	VCA	[03]Channel 1Channel 1Ch...
2020-03-13 10:53:32	VCA	[03]Channel 1Channel 1Ch...
2020-03-13 10:53:18	VCA	[03]Channel 1Channel 1Ch...
2020-03-13 10:52:40	VCA	[03]Channel 1Channel 1Ch...
2020-03-13 10:52:29	VCA	[03]Channel 1Channel 1Ch...
2020-03-13 10:52:29	Motion	[03]Channel 1Channel 1Ch...
2020-03-13 10:52:11	Motion	[03]Channel 1Channel 1Ch...
2020-03-13 10:51:39	VCA	[03]Channel 1Channel 1Ch...

 **Note:**

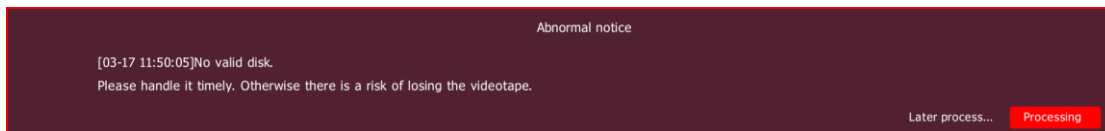

- Users can choose not to display the message, or click “Next” to check the next message.

When an anomaly alarm regarding the risk of video loss occurs, a red warning form will appear to alert the user to deal with the abnormal alarm in time, as shown in the figure below.



**Alarm Message:**

In intelligent analysis, when linkage call is set for the channel and when an alarm occurs, a single screen of the corresponding

channel appears, and the  icon flashes in the upper right corner of the screen. Clicking the icon can open the calling, and at this point, the icon becomes . Clicking the right mouse button can exit the alarm.

#### 4.5.6 Audio Preview and Intercom

##### Audio Preview

After selecting a video channel with mouse or remote control, the system will automatically play the audio of that channel.

##### Voice Intercom

Users can use the voice intercom interface of the device to realize the intercom function between the remote control end and the device. Please connect the pickup and speaker before intercommunication.

#### 4.5.7 Right Back to Preview Interface

On the parameter configuration interface, right-click to return directly back to the preview interface.

### 4.6 PTZ control

#### 4.6.1 PTZ Parameter Setting

 **Notes:**

- Before controlling the dome camera or PTZ of the IP channel, please first confirm that the network is normally connected between PTZ decoder and NVR, and configure the parameters of the PTZ decoder in the device.
- For parameter setting of front-end IPC serial port, see section 4.3.15.
- For parameter setting of NVR local serial port, see System Settings.



#### 4.6.2 PTZ Control

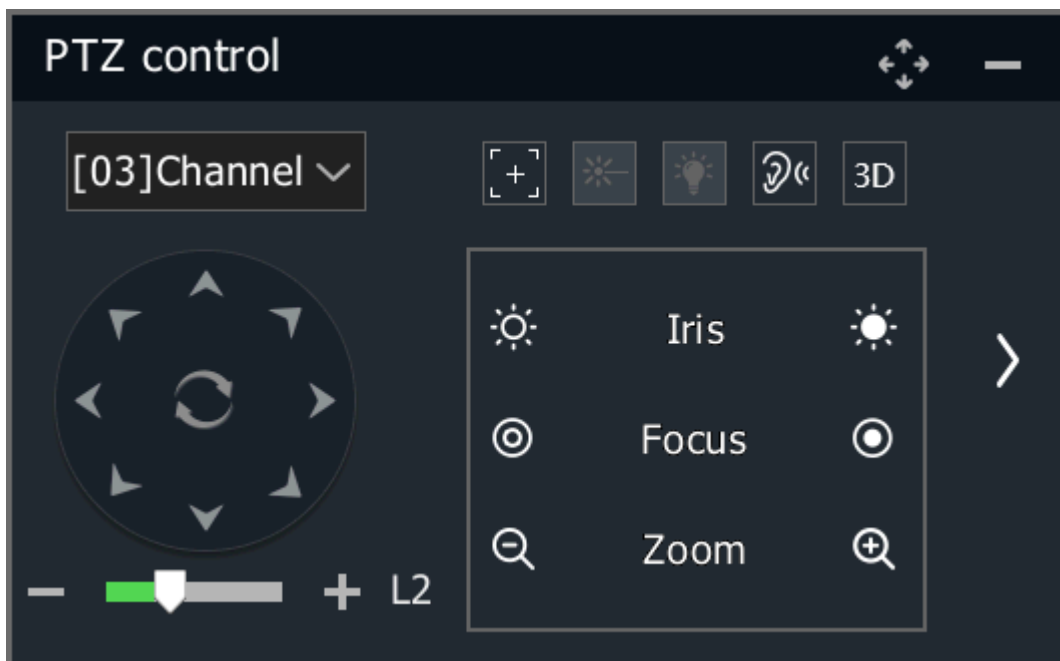





1. In login state, enter the preview state. Use your mouse to click the channel preview screen that requires PTZ control. Click the "PTZ" button in the preview shortcut menu bar to enter the full-screen screen of the channel, and the PTZ control form appears, as shown in the figure below.





2. Select the channel for PTZ control.



3. Description of PTZ control:



1) PTZ control: Use your mouse to click the  button to control up, down, left and right actions of the PTZ; use your mouse to click the  button to control the tilt actions of the PTZ; click the  button to start or stop the automatic pan operation of the PTZ.

2) Lens control: click the  button on the left of the "Aperture" to turn off lens aperture; click the  button on the right to turn on aperture; click the  button on the left of the "Focus" to enable far focus; click the  button on the right to enable close focus; click the  button on the left of the "Zoom" to reduce zoom; and click the  button on the right to increase zoom.

3) Speed setting: click the progress bar to select a value or scroll the mouse wheel to change a value, or click the  or  icon to



increase or decrease the value. The higher the value is, the action speed of the PTZ is greater. The value is L2 by default.

4) Click the  icon to set the one-key focus function, click the  icon to enter the 3D positioning function interface, and click the  icon to set ON and OFF of the front-end laser.

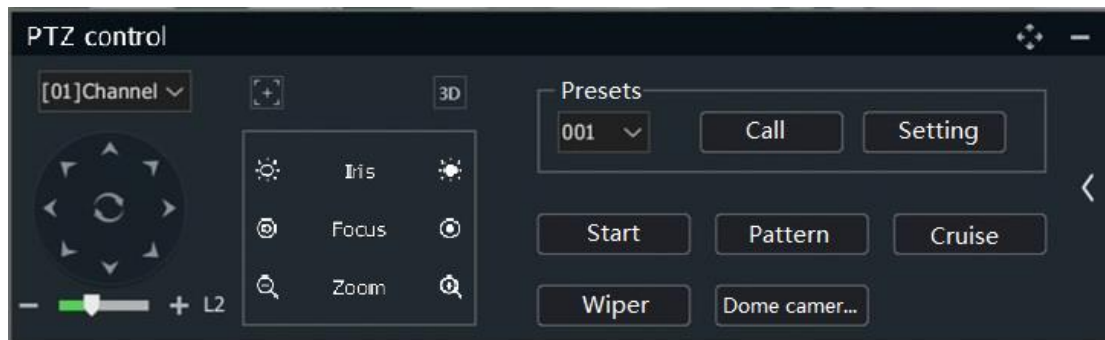
5). Click  and  icons to expand and hide the control menu on the right, as shown in the figure below.



6) Drag the  icon to drag the PTZ control form.

7) Click the  icon to zoom out the PTZ control form. In PTZ zoom-out state, click the  icon to return to the PTZ control form. In PTZ zoom-out state, press and hold the left mouse button to control the PTZ direction of the dome camera according to mouse movement direction.

### 4.6.3 Preset Position, Cruise, Trajectory Settings and Recalling

#### Preset Position Setting and Recalling

- 1、 Recall preset position: Selects a preset position number from the "Preset Position" drop-down list, or enter the preset position number directly and click the "Recall" button to recall the selected preset position.
- 2、 Set preset position: after controlling the PTZ to act to a specific position, select the preset position number from the preset position drop down list or directly input the preset position number, and click "Set" button to complete setting the preset position of this position number.

### **Trajectory Recording and Demonstration**

When you click the "Start Trajectory" button, the button message changes to "End Trajectory", and the system enters the trajectory recording state. At this point, the system will automatically record all operations on the PTZ before users click the "End Trajectory" button. After pressing the "End Trajectory" button, the trajectory recording is completed and the system will automatically exit the trajectory recording state. Users can click the "Demo Trajectory" button to demonstrate the trajectory just recorded.

### **Cruise Path Setting**

1. Click the "Cruise Path" button to enter the cruise path setting interface, as shown in the figure below.

The image shows a "Cruise Setting" dialog box with the following elements:

- Cruise No.:** A dropdown menu set to "01", followed by "Enable", "Call", and "Stop" buttons.
- Cruise Point:** A dropdown menu (currently empty) and a "Delete" button.
- Attribute:** A section containing:
  - Presets:** A dropdown menu set to "001".
  - Time(s):** A dropdown menu set to "1", with "(1~60)" indicating the range, and "New" and "Setting" buttons.
- Bottom Buttons:** "Apply", "Confirm", and "Cancel" buttons.

2. Cruise path setting are described as follows:

(1) View cruise path information

Select a cruise path number from the "Path Number" drop-down list. After selecting a cruise point, the system automatically displays the preset position corresponding to the cruise point and the duration of stay in the preset position.

(2) Edit cruise path

Select the path number you want to edit from the "Path Number" drop-down list. If the path is disabled at this point, press

the "Enable" button to enable the cruise path. Select the preset position number from the "Preset Position" drop-down list, and press "Add" after entering the time, the preset position will be added to the cruise point list of the cruise path. After selecting a cruise point from the cruise point list, click the "Delete" button to remove the cruise point from the cruise point list of the cruise path. After a cruise point is selected, select a preset position from the preset position dropdown list, and click the "Set" button after the time is entered to modify the configuration information of the selected cruise point.

### (3) Enable/disable cruise path

Select a cruise path number from the "Path Number" list to enable or disable the path.

### (4) Recall/stop cruise path:

Click the "Recall" button to cruise according to the set path. Click "Stop" to stop the current path cruise.

### (5) Exit the cruise path setting interface

Click the "OK" button to save all the path editing operations on the cruise path setting interface into the system, and then exit the



path setting interface. When pressing the "Cancel" button, the system will automatically ignore all editing operations and exit the path setting interface.

#### (6) 3D positioning

Users can select any area on the video screen with the mouse, and the system will automatically control the action of the PTZ lens to realize the zoom-in/out function of the display scene (drawing a rectangle from left to right for zooming in from and right to left for zooming out).

#### 4.6.4 USB Keyboard Controlled PTZ

1. In preview mode, select the channel for PTZ control by using [↑] [↓] keys and press P. At this time, the system will display the selected channel on a single screen. The upper right corner of the screen displays "PTZ ChnXX" to alert users that the system is in the PTZ control state of the XX channel.

#### 2. Controlling PTZ Actions

- PTZ control: In the PTZ control mode, press [↑][↓][←][→] keys to control the PTZ up, down, left and right; Press the "Enter" button, the PTZ starts automatic pan action and press the "Enter" button again, the PTZ stops automatic pan action.

- Lens control: In the PTZ control mode, press I or G to turn on the lens aperture; press Ctrl+I or Ctrl+G to turn off the lens aperture; press Z or B to zoom in; press Ctrl+Z or Ctrl+B to zoom out. Press F or J to enable far focus; and press Ctrl+F or Ctrl+J to enable close focus.
- Recall preset position: In PTZ control mode, press the [Backspace] key, and then [Number] key, and then [Enter] key, the system will recall the corresponding preset position.
- Speed setting: In PTZ control mode, press the numeric keys [1] - [4] to set the speed of the PTZ.
- Exit the PTZ control mode: Click [ESC] in the PTZ control mode to return to the preview mode.

## 4.7 Storage Setting

### 4.7.1 Recording

#### **Basic**

1. Select "Main Menu -> Storage Setting -> Recording -> Basic " to enter the recording interface, as shown in the figure below.

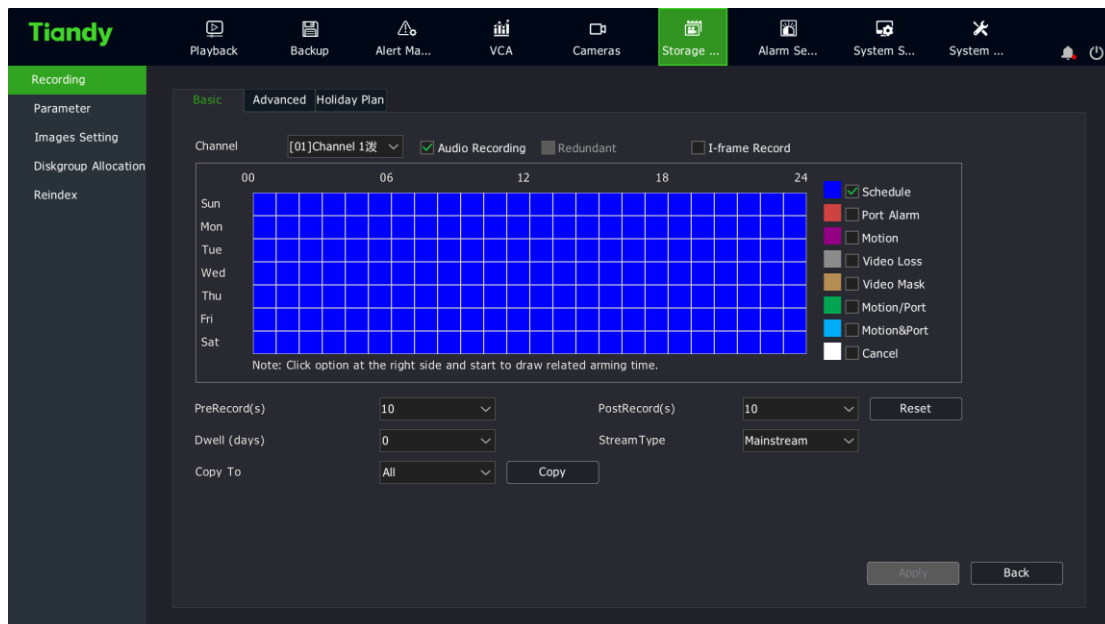

2. Select the channel to set.

3. Select whether to "Audio Recording", whether to enable "Redundant", and whether to enable "I-frame Record".

- When "Audio Recording" is not checked, only video data is saved in the video file.
- When there are redundant disks in the system and the "Redundant" function is enabled on the selected channel, recordings and captured image files will be saved in both the recording disk and redundant disk.
- If "I-frame Record" is enabled, the system will posterize video files, which can greatly save the hard disk space for the videos of non-key areas.

4. Select video type. Options include "Schedule" , "Port Alarm" , "Motion" , "Video Loss" , "Video Mask" , "Motion/Port" , "Motion&Port" . You can check "Cancel" to delete the set video types.

5. Press and hold the left mouse button and drag over the time zone, and the selected time zone will be updated as the specified video type.

6. Set the pre-recording and delay time of alarm videos.

- PreRecord: Assuming that the pre-recording time set by the user is 5s, the system will automatically save the video information to the video file 5s before alarming.
- PostRecord: The delay time of video is applied to the alarm video. Assuming that the delay time set by the user is 5s, the system will automatically save the video information to the video file 5s after alarming ends.
- The combination of prerecord and postrecord: can facilitate the user to analyze the monitoring information before and after the occurrence of alarms.

7. Dwell: Set the maximum retention time of videos in days. 0 means no restriction, and the maximum retention time of videos is 120.

8. StreamType: Set the stream type of videos, including MainStream and SubStream. Some models also support dual stream recording.

9. Click "Apply" to save the configurations.

## Advanced

1. Select "Main Menu -> Storage Setting -> Recording -> Advanced" to enter the video template advanced setting interface, as shown in the figure below.

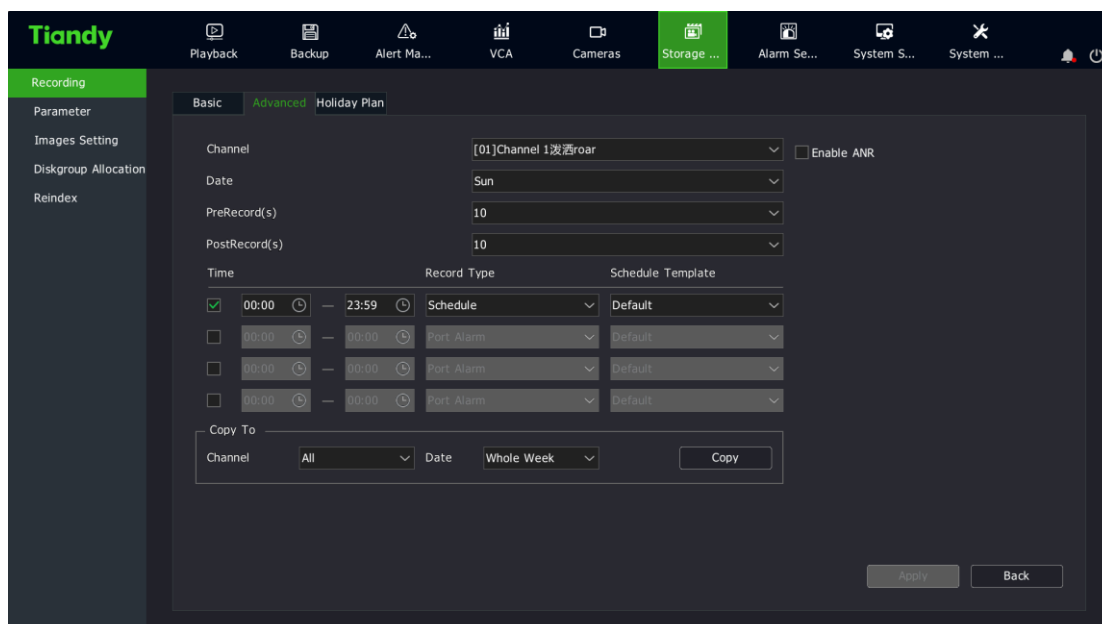

2. Select the channel to set.

3. Set whether to enable the ANR function of front-end IPC. If enabled, IPC will automatically start the local recording when the IPC is disconnected, and automatically upload the locally saved videos to the NVR when the IPC gets online again.

4. Select the pre-recording time from the "PreRecord" drop-down list.
5. Select the video delay time from the "PostRecord" drop-down list.
6. Set the time period and the video type within the time period. Click the "Time" option box to make it selected. Enter the start and end time of the time period into the time period input box. Select a video type from the "Record Type" drop-down list. Different video types can be specified for different time periods.
7. Copy the parameters of the current template to the channel and date.
8. Click "Apply" to save the configurations.

#### **Holiday Plan:**

You can configure holiday video plan of the year. When holiday plan is enabled, the video plan will be implemented first during holiday time.

1. Select "Main Menu -> Storage Setting -> Recording -> Holiday Plan" to enter the "Holiday Plan" interface, as shown in the figure below.

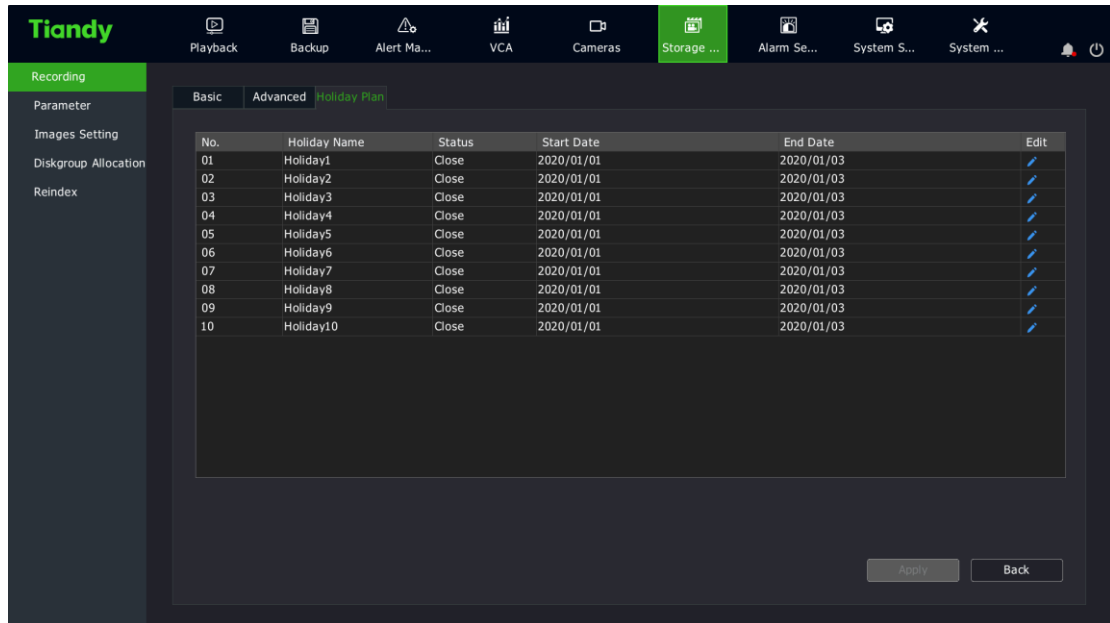

2. Click a holiday in the selected list, and click "Edit" or double click the left mouse button to enter the "Holiday Setting" interface.

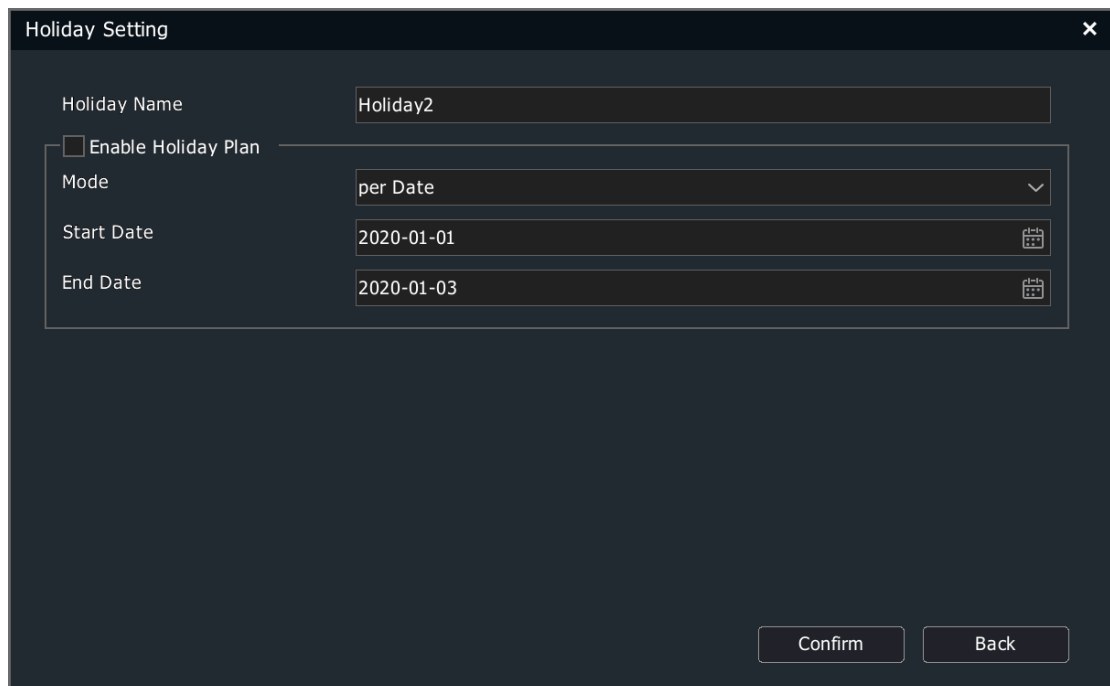

3. Check "Enable Holiday Plan" and choose the setting mode of the holiday "per Date", "per Month" or "per Week". Enter the start date and end date of the holiday. Click "OK" to save the configurations.

4. After enabling the holiday plan, you can select the holiday from the "Date" in "Advanced " and set the corresponding video template for the holiday. Videos will be recorded according to this template for all enabled holiday plans.



**Note:**

- All configurations by week take Sunday as the first day of the weekday, unless otherwise specified.



## 4.7.2 Parameter

1. Select "Main Menu -> Storage Setting -> Parameter" to enter the video policy setting interface, as shown in the figure below.

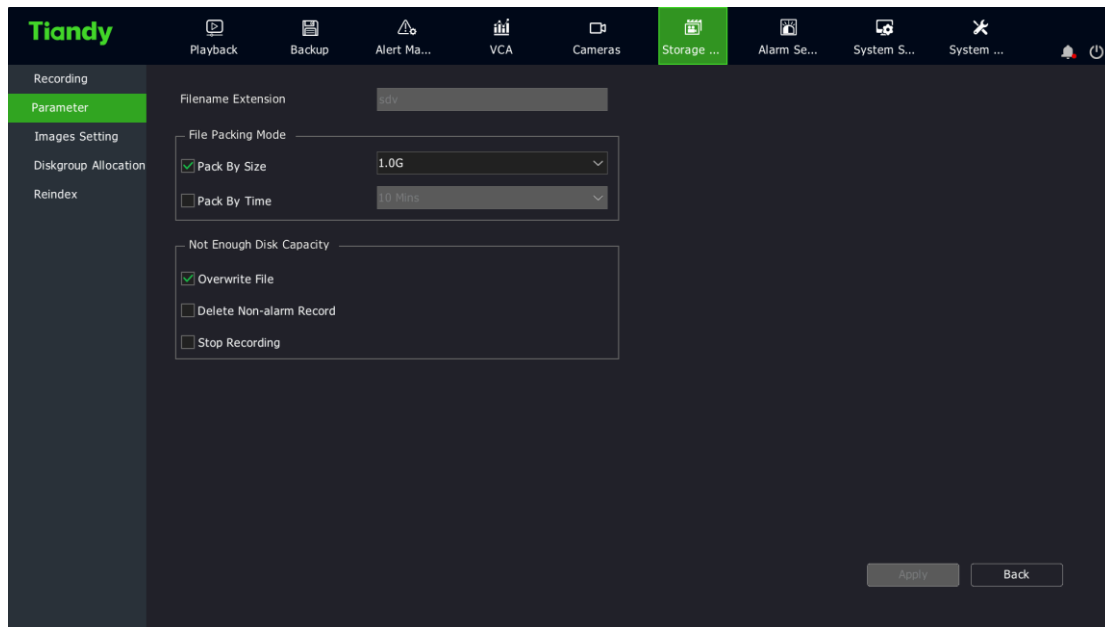

2. Select the processing method of the system when the disk space is insufficient, such as "Overwrite Files", "Delete Non-alarm Record" or "Stop Recording".

3. Click "Apply" to save the configurations.

## 4.7.3 Diskgroup Allocation

1、 Select "Main Menu -> Storage Setting -> Diskgroup Allocation" to enter the disk pack configuration interface, as shown in the figure below.

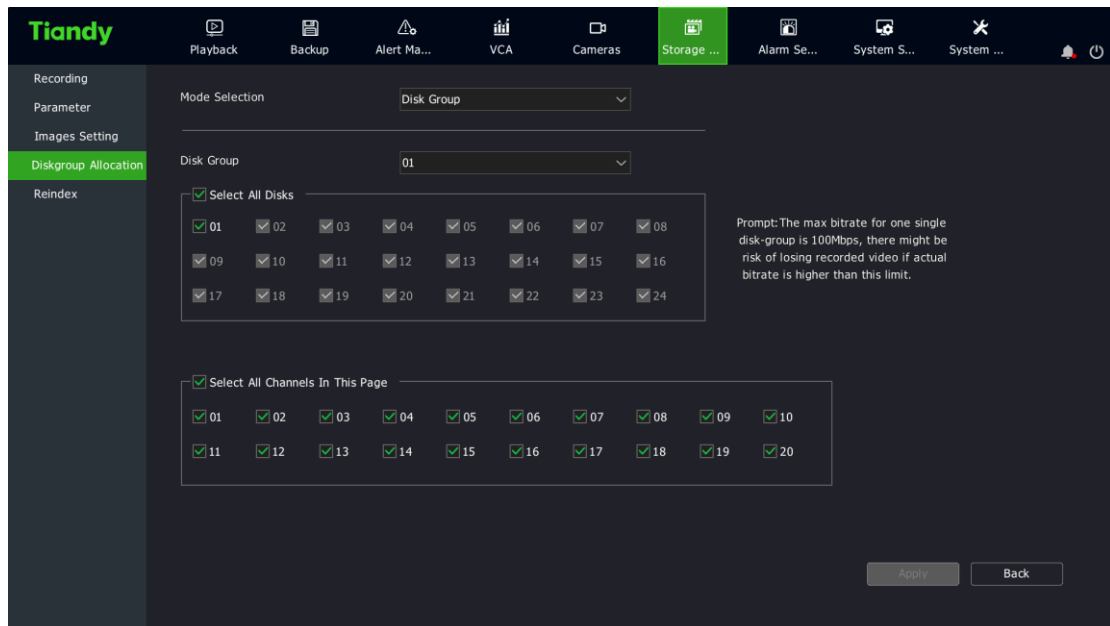

## 2. Set disk group or quota.

**Disk Group:** Divides hard disks mounted on the NVR multiple disk packs. You can specify the disk pack where the video files are located for each channel.

**Quota:** Specifies the maximum disk space a channel's video files can use. Different channels can be configured with different video space.



### **Note:**

- Mode switching can come into effect only after the device is restarted.

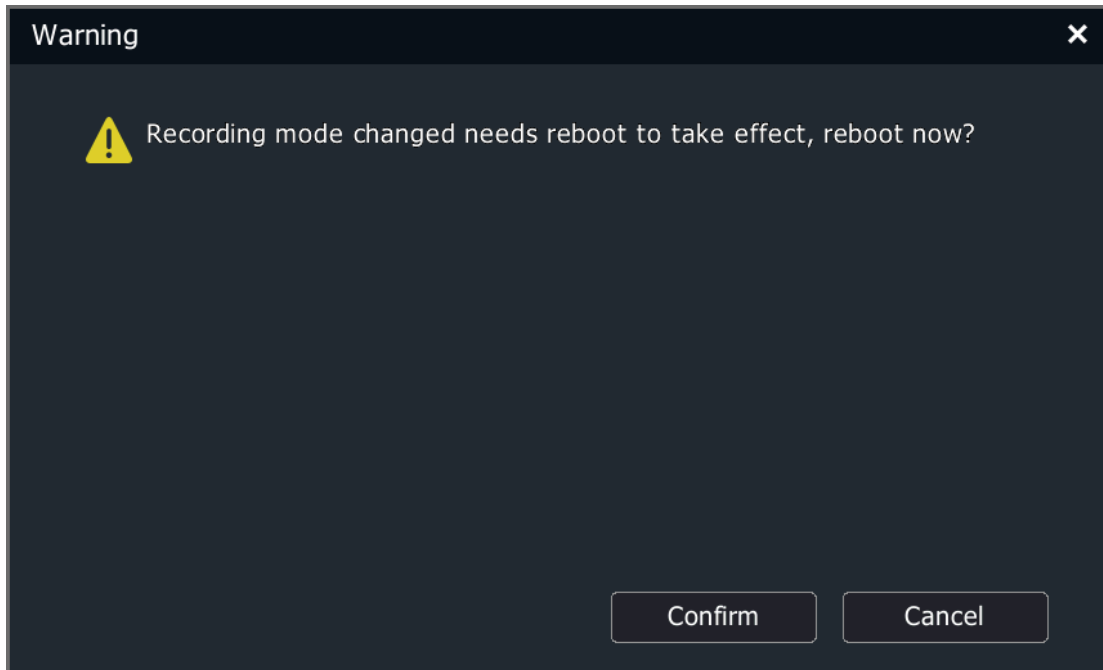

3. Set the disk group.

(1) Select "Disk Group" under "Mode Selection".

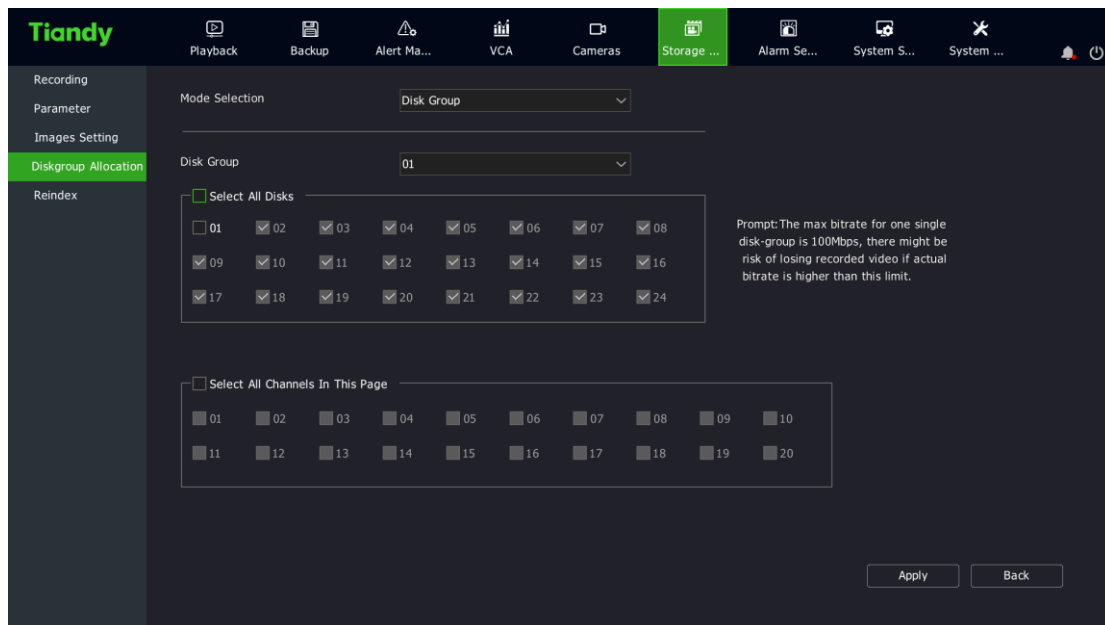

(2) Select disk group. There are disk groups 1 - 8 to choose from the drop-down box.

(3) Select disks for a disk group. Sets which disks belong to the disk pack. Check "All Disks" to select all available disks. A disk cannot be assigned to more than one disk pack at the same time.

(4) Select a channel for a disk group. Select which channels to record in the pack.

(5) Click the "Apply" button to save the settings.



**Notes:**

- The storage bitrate of a single disk pack can be up to 100Mbps; otherwise there is a risk of video loss.
- When ESATA is a non-backup disk, it appears in the All Disks box.
- There are 20 channels in one disk pack for NVR by default. The rest can be done in the same manner.

#### 4. Quota Configuration

(1) Select "Quota" under "Mode Selection".

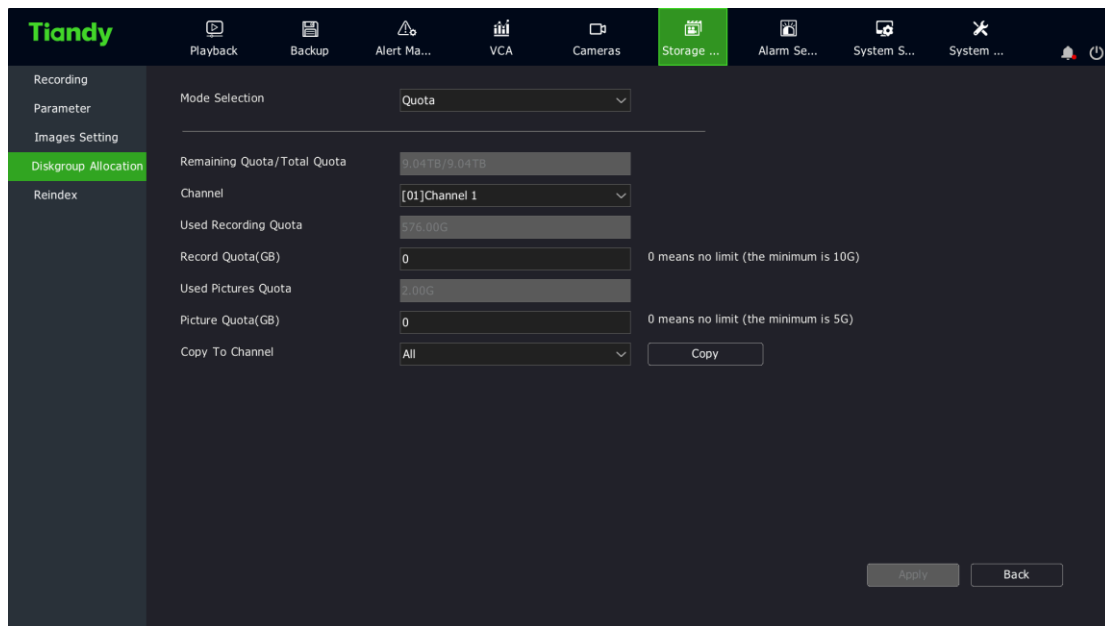

(2) Select the channel to set. Select the channel where you want to set the quota from the “Channel” drop-down box.

(3) Set the video quota. Sets the maximum storage space that video files of the channel occupy, in GB. 0 indicates unlimited.

(4) Set the image quota. Sets the maximum storage space for the image files of the channel, in GB. 0 indicates unlimited.

(5) Save the settings. Click the “Apply” button to save your settings.



**Note:**

- Quota mode is not recommended for devices with over 40 channels.

#### 4.7.4. Images Setting

1. Select "Main Menu -> Storage Setting -> Image Setting" to enter the snapshot setting interface, as shown in the figure below.

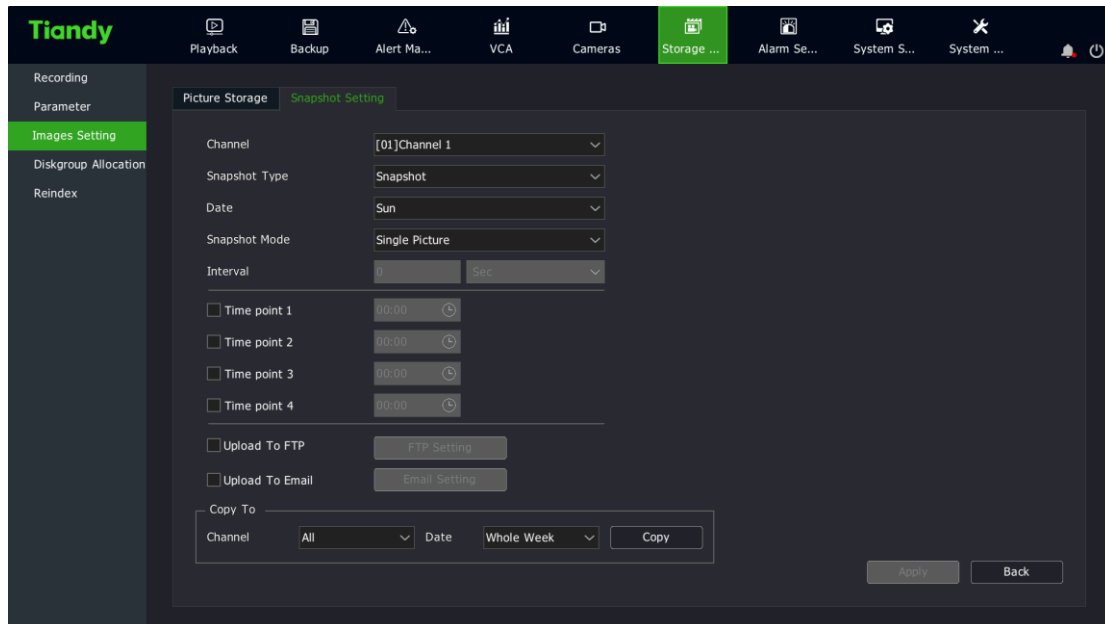

(1) Select the target channel number for the snapshot setting operation.

(2) Set snapshot type: "Snapshot" and "Alert Snapshot". When "Alert Snapshot" is selected for snapshot type, the snapshot setting interface is shown in the figure below.

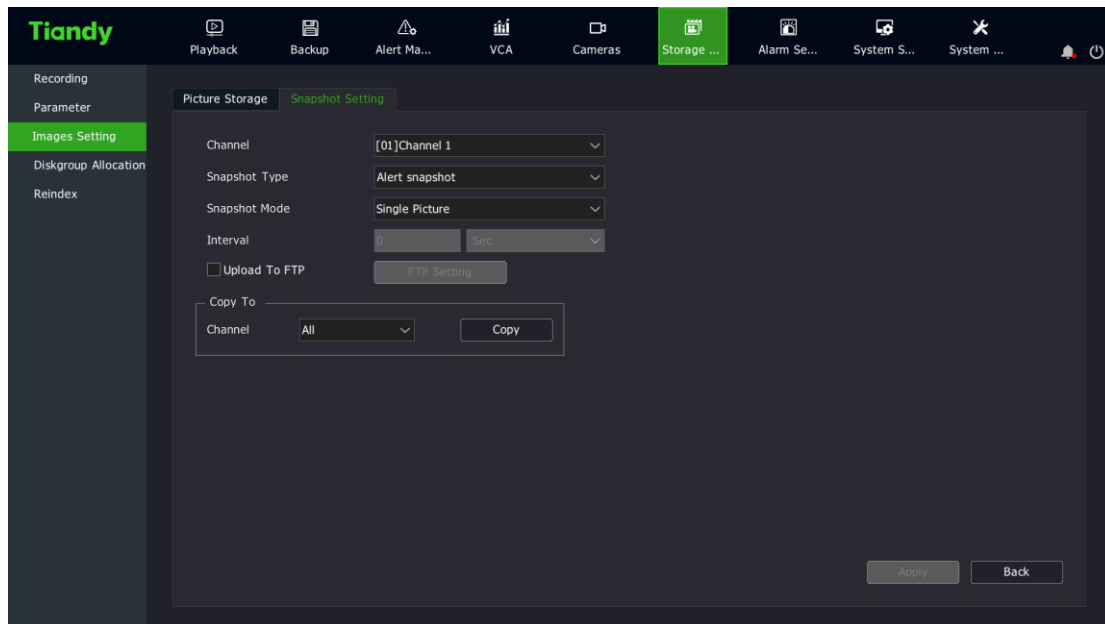

(3) Set snapshot mode: "Single Picture" and "Multiple Pictures".

(4) Set the time interval of snapshot, in seconds.

(5) Choose whether to upload captured pictures via FTP. Click the "Upload To FTP" button to enter the FTP setting interface. For details about FTP settings, refer to the corresponding section.

(6) Choose whether to upload the captured pictures via SNMP. Click the "Upload To Email" button to enter the Email setting interface. For details about settings, refer to the corresponding section. On this interface, Email Setting is unavailable for alarm snapshot.

(7) The snapshot setting parameters of the current channel can be copied to the specified channel.

(8) Click "Apply" to save the configurations.



## Note:

- The system can snapshot at most 2000 pictures per channel within 24 hours. The snapshot count will be cleared after the system is restarted.

### 4.7.5. Reindex

When HDD exception or video loss occurs, lost videos can be retrieved to the maximum extent by rebuilding the index.

1. Select "Main Menu -> Storage Setting -> Reindex" to enter the "Reindex" interface, as shown in the figure below.

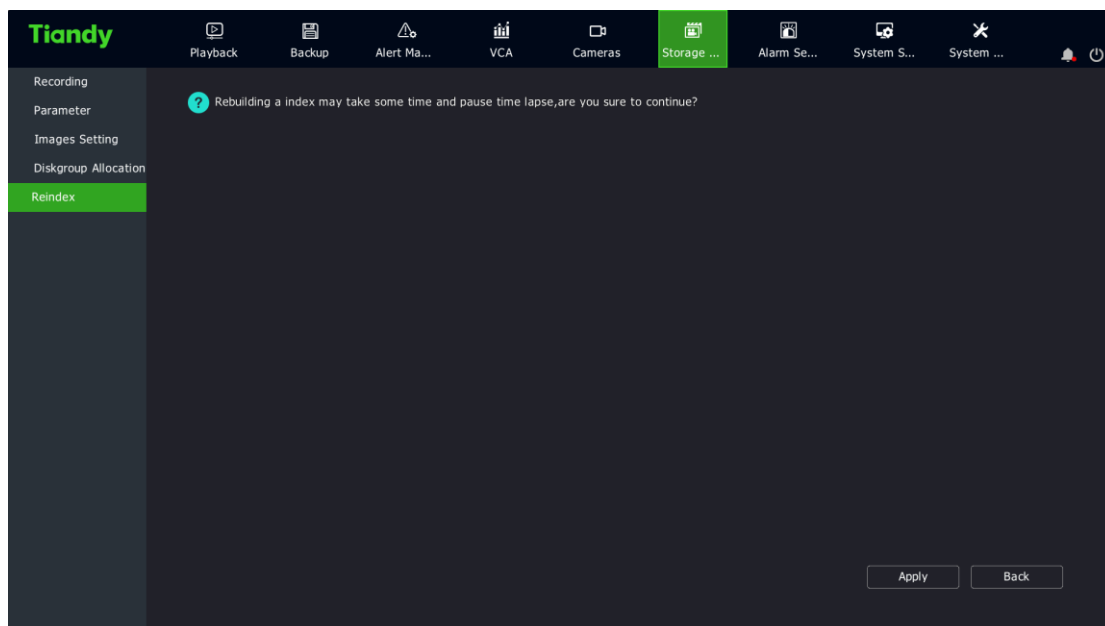

2. Click the "Continue" button to start the rebuild operation.
3. When rebuilding the index, users can exit the interface for other operations.



## 4.8 Playback

### 4.8.1 Instant Playback

On the preview screen, play back the video file of the selected channel within 5 minutes.

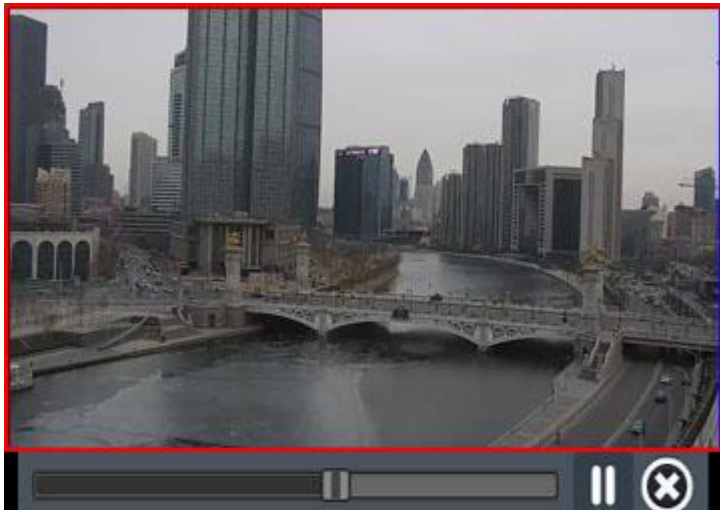

In preview state, select the channel to played back by using the left mouse button, and click the  button on the shortcut menu, and enter the "Playback" interface, as shown in the figure above.







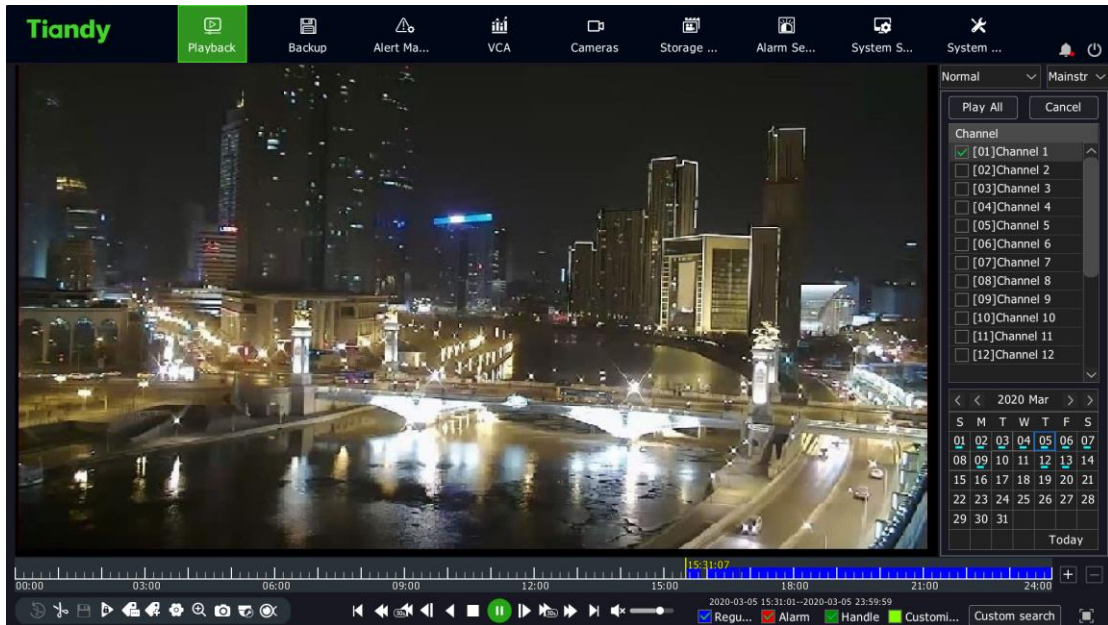

### 4.8.2 Description of Playback Interface

Here, the composition and function modules of the playback interface are introduced.

To enter the menu playback interface: preview and use "Right-Click Menu-> Playback" to enter the playback interface, as shown in the figure below.



### Description of playback control bar

Button	Description	Button	Description	Button	Description
	Turn sound on/off		Start/ended clip		File management
	Save clips		Add default tag		Add custom tags
	Digital zoom		Intelligent retrieval		Tripwire/perimeter search

	People count		Face detection		Search OK/cancel/ exit
	Pause/reverse		Forward by 30s		Pause/play
	Stop		Reverse by 30s		Step forward
	Fast forward		Slowly into the		The day after
	Step back		The day before		Timeline reduction
	Playback timeline		Timeline magnification		Lock file
	Playback location/snapshot		Snapshot		

### 4.8.3 Normal Playback

Retrieve the corresponding video files by channel and date, and play video files in turn from the generated play bar that meets the criteria. The playback steps are as follows:

- 1、 Select "Main Menu -> Playback" to enter the "Normal" interface, as shown in the figure below.
- 2、 Select the channel to play back and the calendar automatically displays the recordings of the month.
- 3、 Use your mouse to click the date you want to play back.
- 4、 The system automatically plays the video files that meets the criteria.

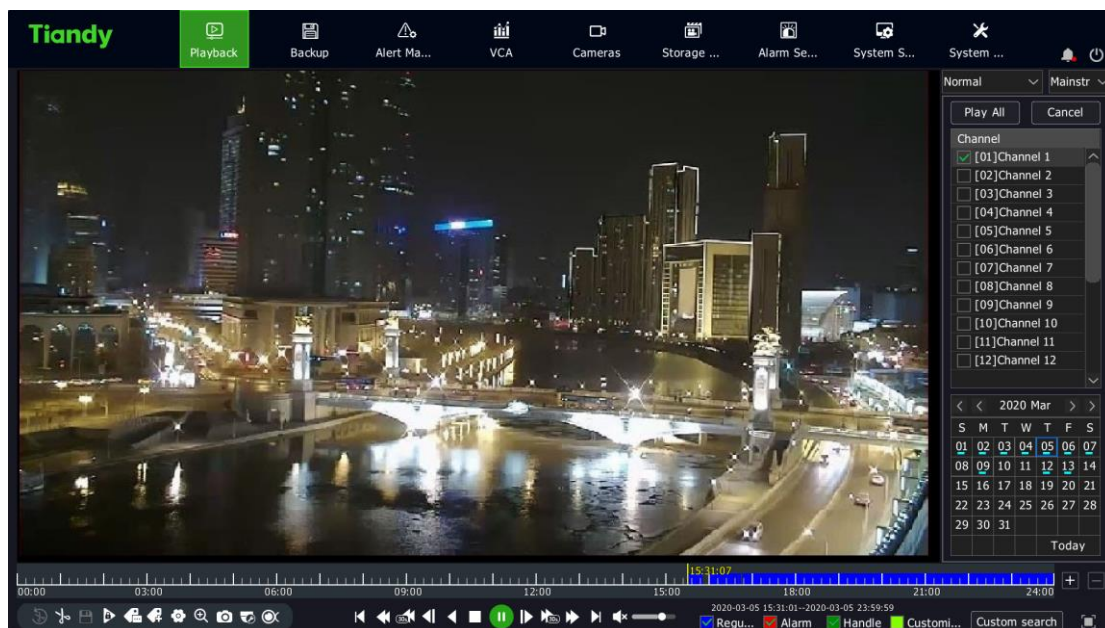

- 5、 Other playback operations.

- Use the "Full Screen" key in the upper right corner to enable full screen playback.
- If there is no operation for a period of time during playing, it will automatically enter the full-screen playing mode. You can operate the mouse or keyboard again to exit the full-screen.
- Use "Fast Forward" or "Slow Forward" key to fast or slowly play back videos.



**Note:**

- Up to 16 channels can be played back at a time. The playback performance differs depending on the device model and video recording.

#### 4.8.4 Event Playback

Query a video file in a certain time period by event type (port alarm, motion detection, video loss, video occlusion, intelligent analysis), and play the video from the generated list that meets the query criteria. The operation steps are as follows:

- 1、 Enter the playback interface, and select "Event" for the playback mode.
- 2、 Select event type in the upper right corner of the playback screen.
- 3、 Select the channel to play back.

4、 Click the date you want to play back.

5、 The system automatically plays the video files that meet criteria.

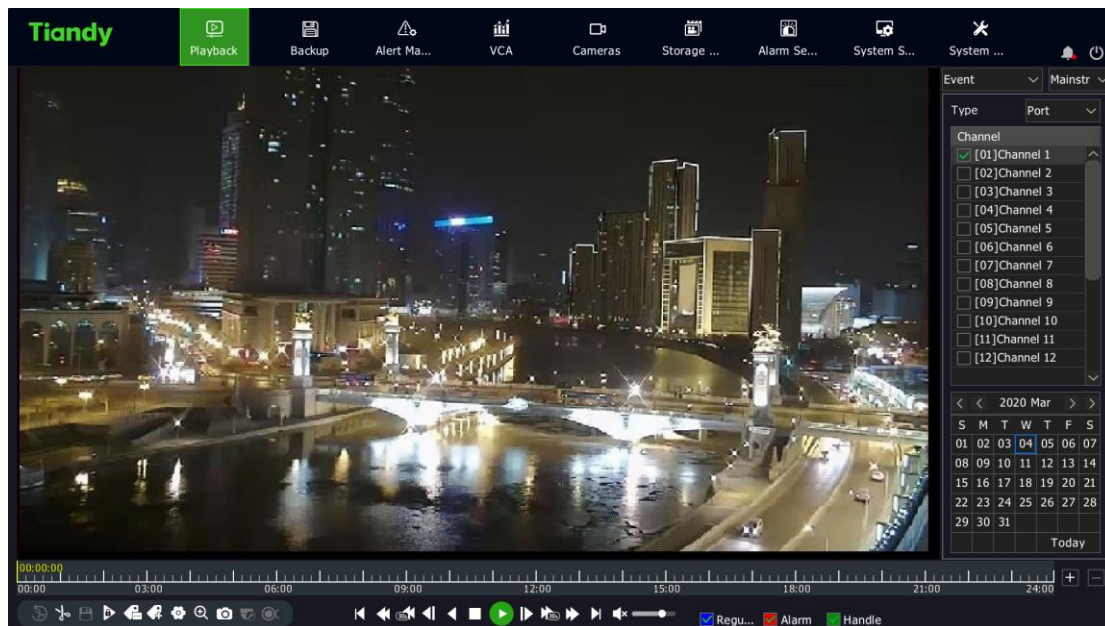

#### Note:

- During event playback, the player will skip the time period without alarm video according to the alarm time period of the video.

### 4.8.5. Tag Playback

The video label function allows users to record the relevant personnel or on-site information at a certain time when the video is played back, so that users can retrieve the information at any time to search and locate the video.

#### Add/Manage Labels

1、 Enter the video playback interface

Click  to add the default label.

Click  to enter a label name and add a custom label.

## 2、 Label management

Click  to enter the "File Management" -> "Label Management" interface, as shown in the figure below, where you can view, edit, and delete added labels.

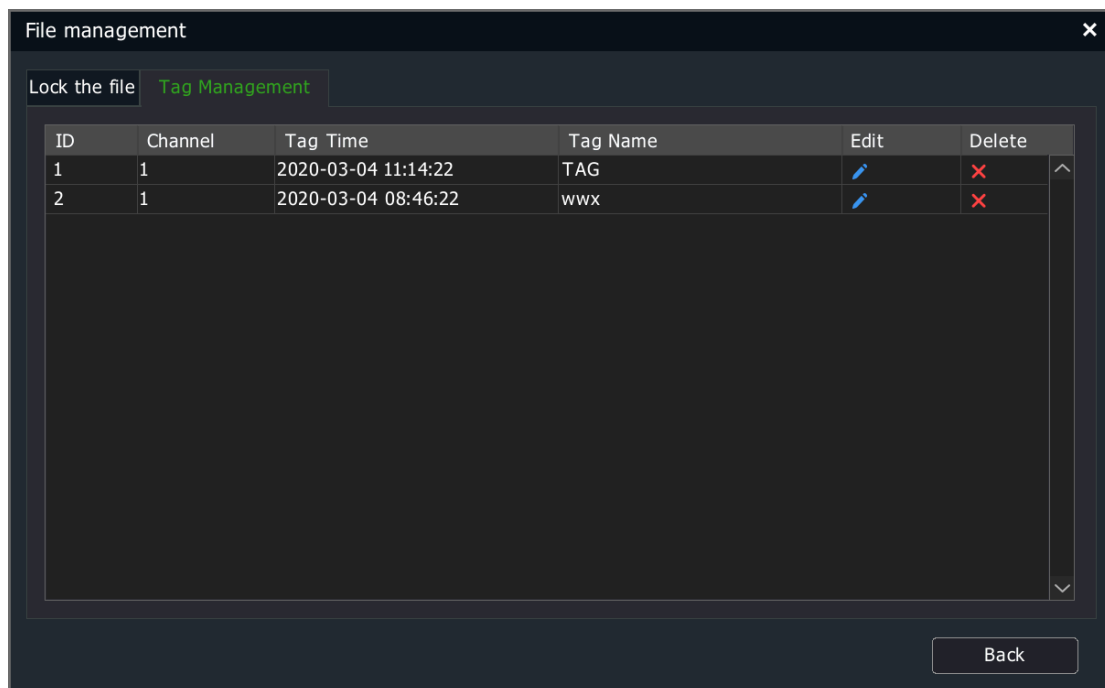

## Tag Playback

- 1、 Enter the playback interface, select "Tag" for playback mode, and enter the "Tag" interface, as shown in the figure below.
- 2、 Select a channel.
- 3、 Enter the label keyword. If no keywords are entered, all labels within the specified date of the selected channel are retrieved by default.

4、 Select a date.

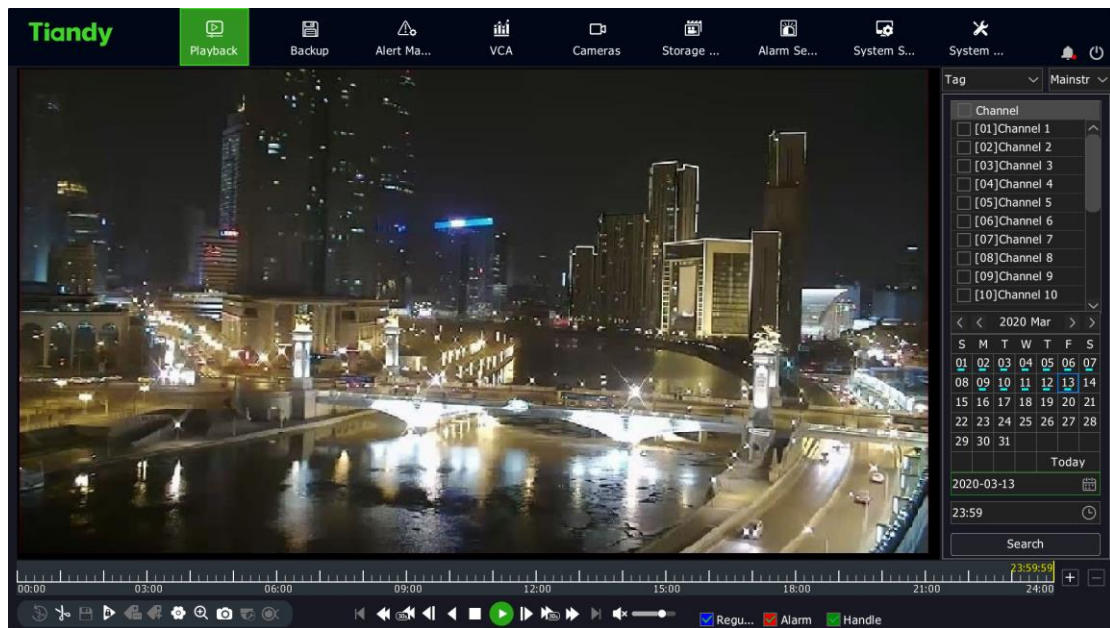

5、 The playback progress bar shows a label marked with an inverted green triangle. When the mouse cursor is moved over the position marked by the inverted triangle, the label name information will be displayed automatically, as shown in the figure below.

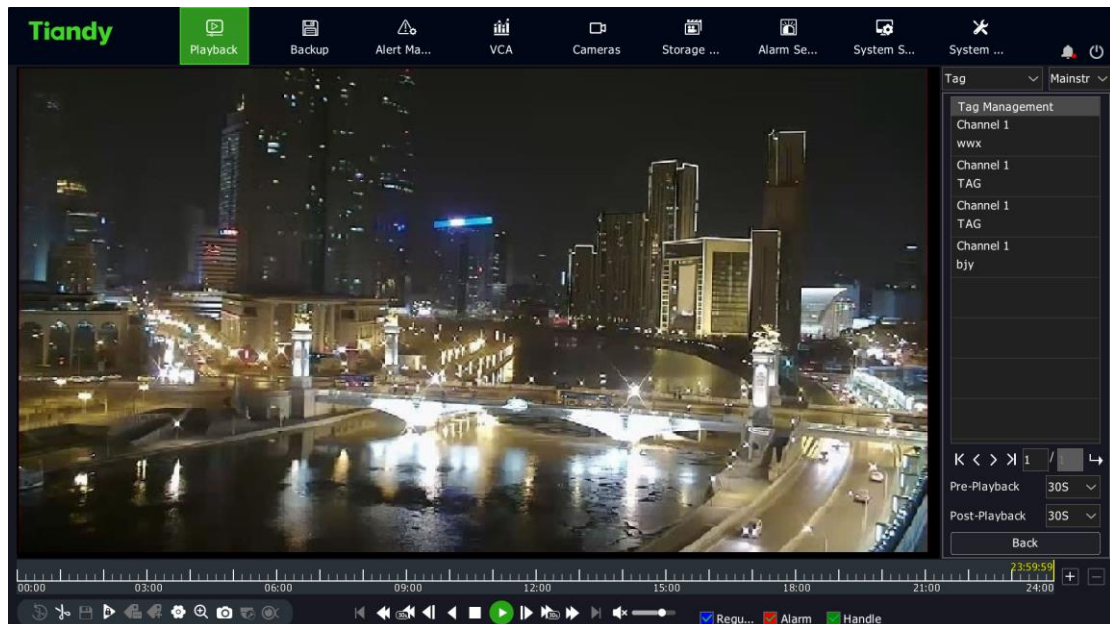

 **Note:**



- Video playback begins with the value set in "Pre-Playback" before the time of adding labels, and ends with the value set in "Post-Playback" after the time of adding labels. When finished, the system automatically jump to the next label for playback.
- Playback Advance Time and Playback Delay Time can be set separately.

#### 4.8.6 Smart Search Playback

Smart search playback refers to the intelligent analysis of video files. Options include "Perimeter Search", "Tripwire Search" and "Face Detection".

The operation steps are as follows:

- 1、 Enter the playback interface and select "Smart Search" for the playback mode, as shown in the figure below.

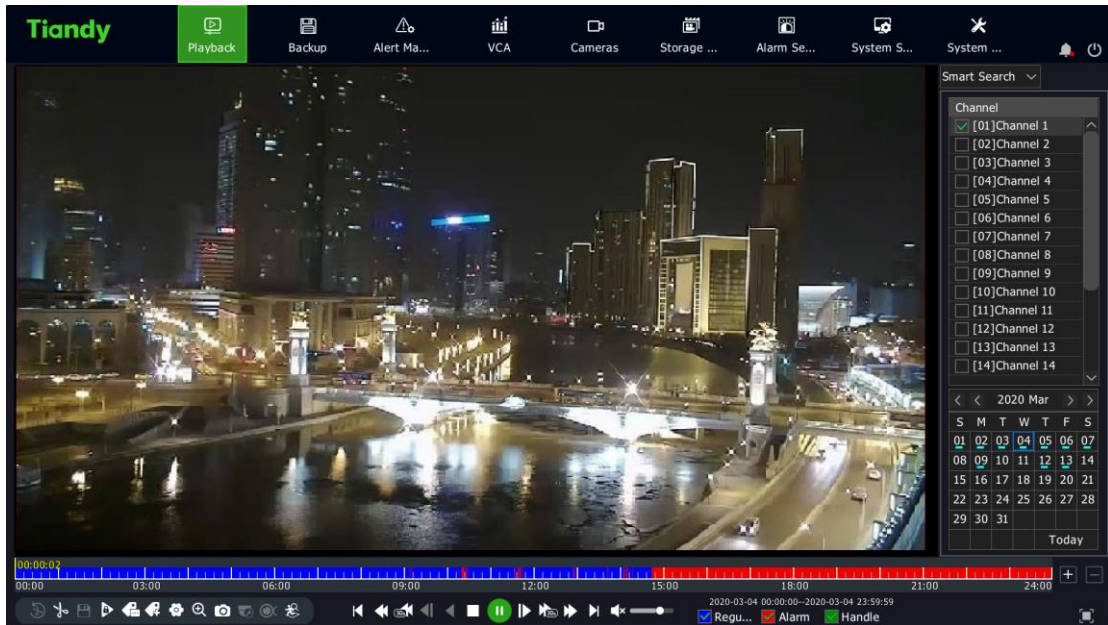

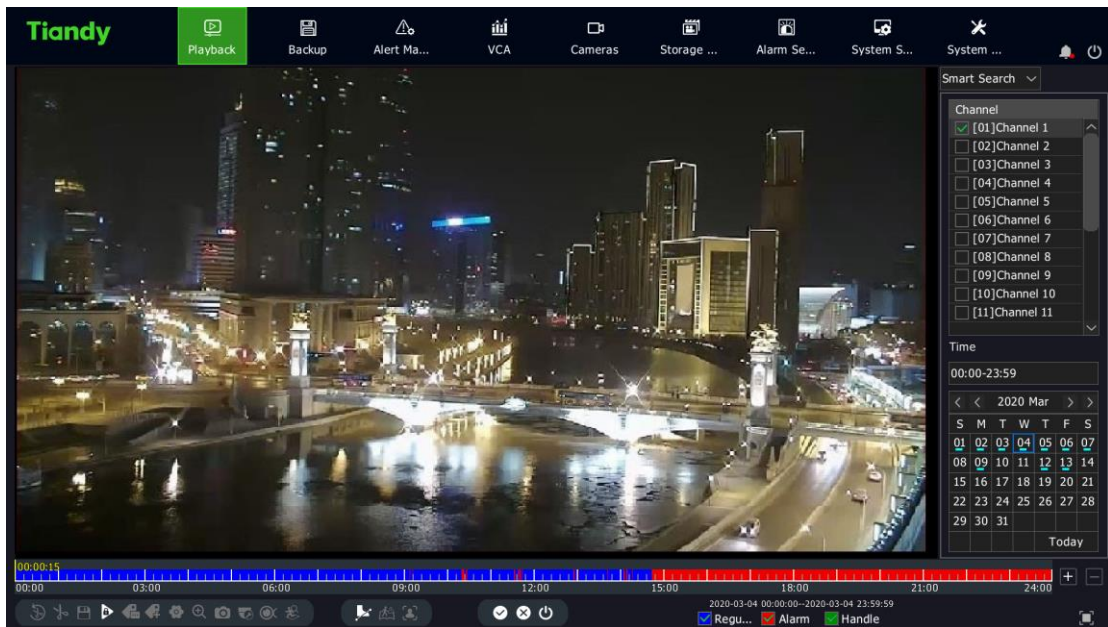

2、 The play operation begins after the channel and date are selected.

3、 Click  in the lower left corner of the interface to enter the intelligent retrieval interface, as shown in the figure below.



4、 Click the  button at the bottom of the interface and select the retrieval type.

#### 4.8.6.1 Tripwire and Perimeter Search

- 1、 Click  or  button to enter the drawing interface of intelligent playback and draw lines on the video, as shown in the figure below.

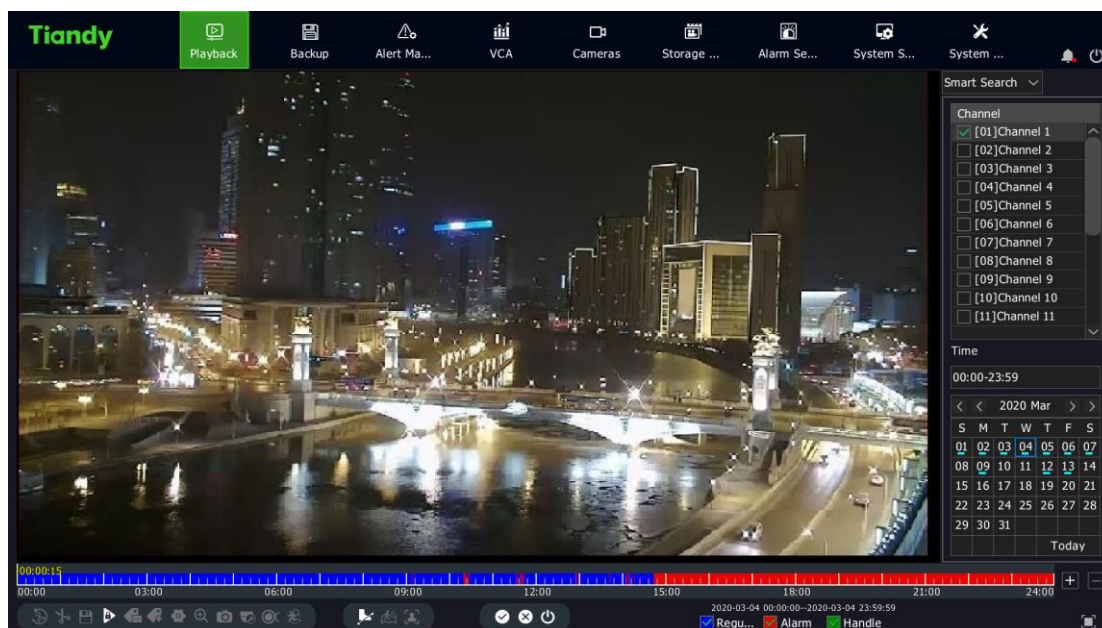

- 2、 Click the  button to start searching. During the search process, "VCA SEARCHING..." appears in the top left of the screen and the progress bar will show the progress and results of the search.
- 3、 During the search process, the system automatically jumps to the search results to start playing.

- Click on another channel or other date during the search process will automatically stop searching. You can also click the Stop button or Exit button to manually stop searching or exit the intelligent search.

#### 4.8.6.2 Face Detection

- Click  to enter the "Face Detection" interface of intelligent playback, as shown in the figure below.



- Click the  button to start searching. During the search process, "VCA SEARCHING..." appears in the top left of the screen. At the same time, the progress bar will display the search progress, and one the right side is the face detection search results.



- 3、 Click on the Stop search during the search process will stop searching.  
When you click the search results on the right, the video will be positioned to the corresponding location.

#### 4.8.7 Video Concert Playback

The video summary playback function is to superimpose multiple moving targets at different time points into the same background for simultaneous playback, which can shorten video time and greatly improve the efficiency of video playback. Before playing back video summary, make sure that the front end device connected to the selected channel supports and enables the intelligent analysis function.

The operation steps are as follows:

- 1、 Enter the playback interface, and select "Video Concert" for the playback mode, as shown in the figure below.

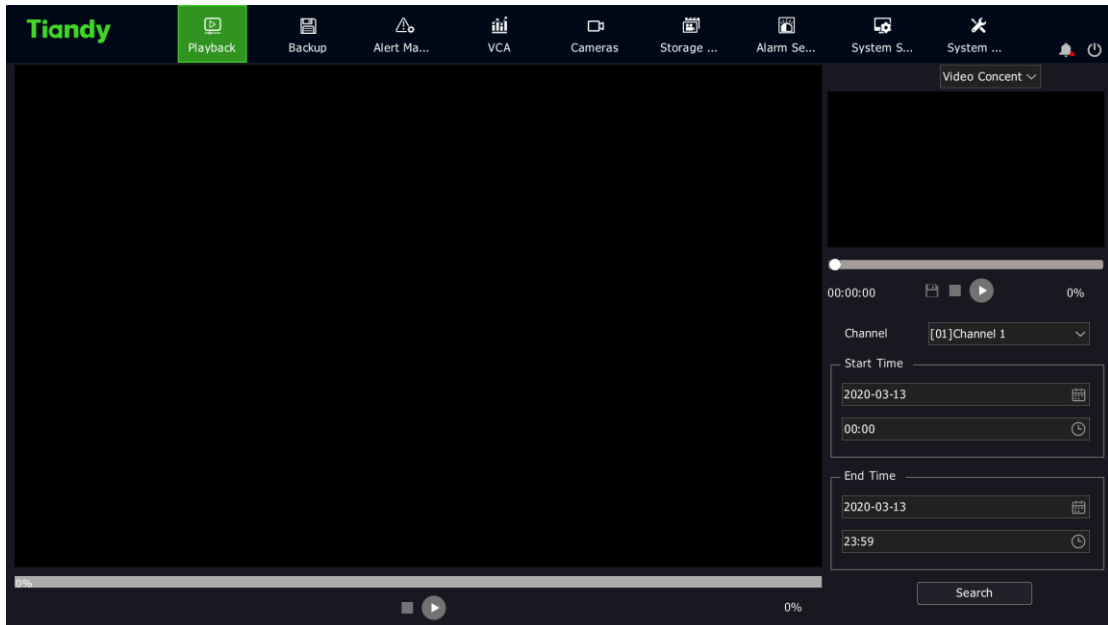

- 2、 Select a channel, set the start and end times, click "Search", and play back the video summary video file, as shown in the figure below.

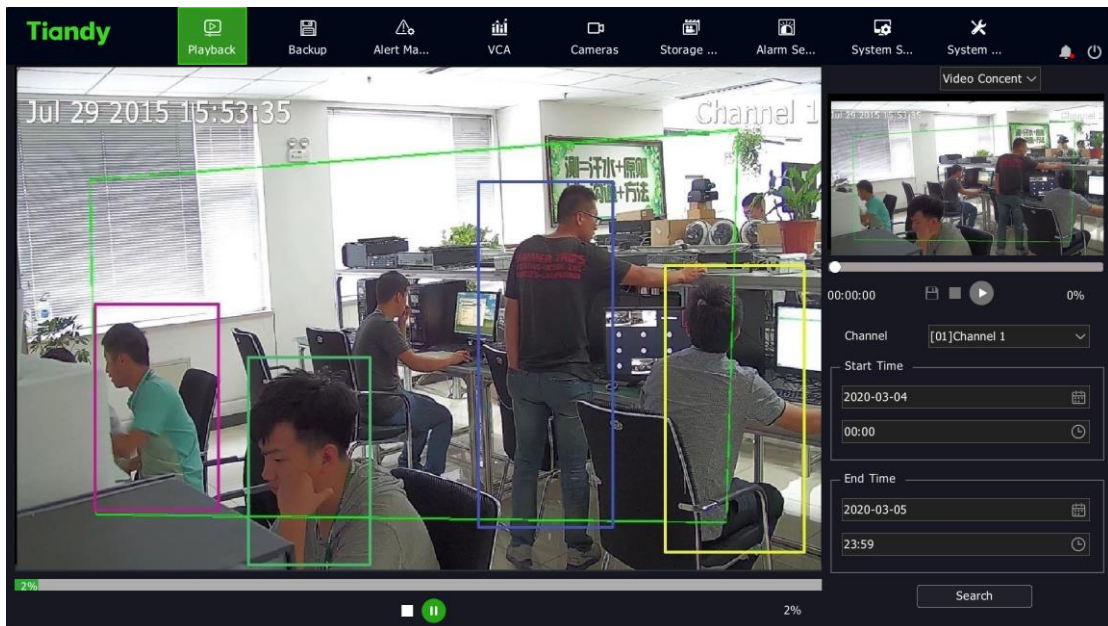

- 3、 Double-click the rectangular box stacked on the left side to locate the time to play in the small window on the right, and then play the video of 30s before and after the time point.



## Notes:

- Stop and Pause options are available on the large screen on the left, and both the progress bar and percentage can be displayed but dragging over the progress bar is impossible.
- Stop and Pause options are available on the small screen on the right. And both the progress bar and percentage can be displayed, and dragging over the progress bar is possible. In addition, current files can be backed up.
- 4 decoding channels can be superimposed on the target simultaneously. The actual number of superimposing layers depends on the decoding ability. With the real-time playback screen of channel 1 as the background, the targets of other channels are superimposed on channel 1.
- The time period of each decoding channel is generally evenly distributed according to the time length of target information.
- Video summary playback is only available for some models.

### 4.8.8 Time-phased Playback

The time-phased playback function means that the recording time of a channel in a day is averaged to multiple screens for asynchronous

playback according to the number of split screens, which can effectively improve playback efficiency.

The operation steps are as follows:

1. Enter the playback interface and select "Time-phased Playback", as shown in the figure below.

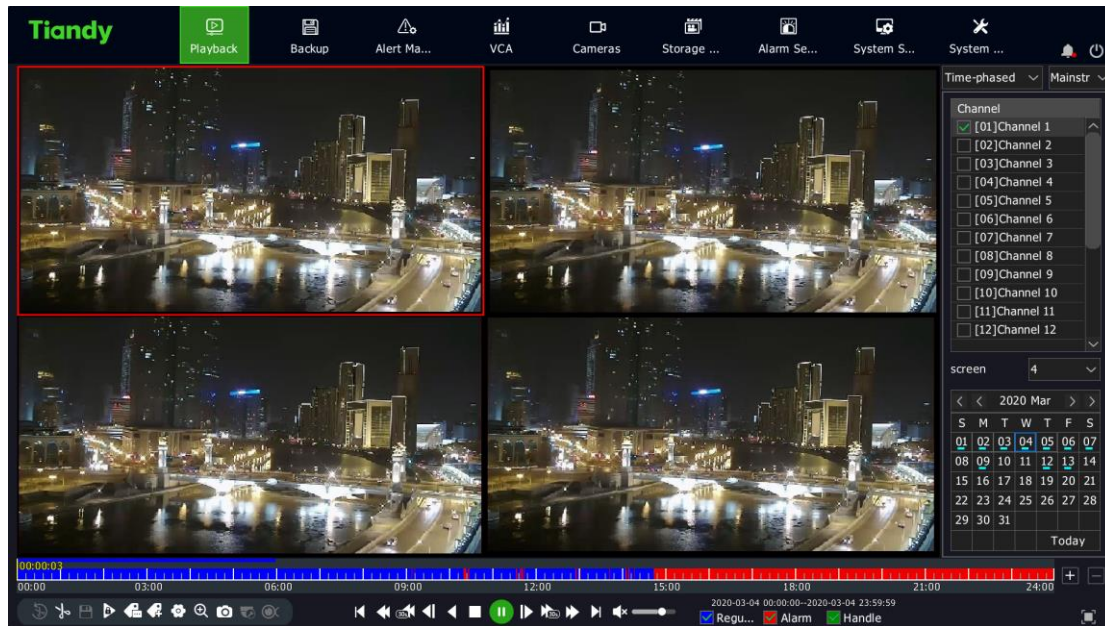

2. Select the playback channel and set the number of split screens. Here, 4 split screens are taken as an example.
3. Select the date on the right side or click the Play button for time-phased playback.

#### 4.8.9. Picture Playback

The picture playback function refers to the playback of the pictures stored in the hard disk, as shown in the figure below.



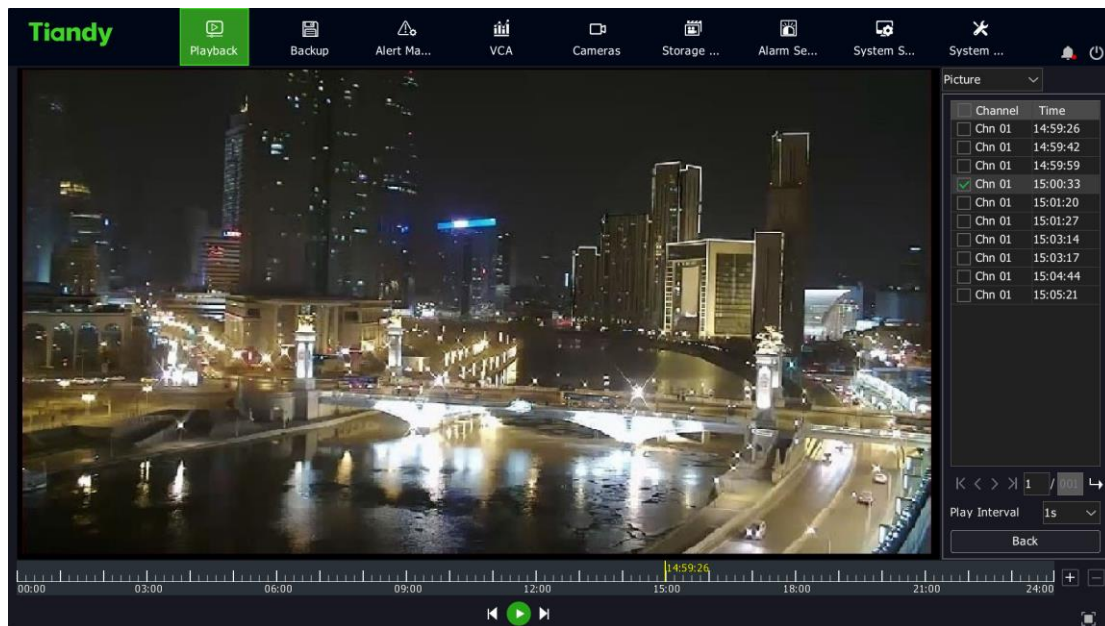

### Notes:

- Users can define a play interval for play pictures automatically.
- You can also pause the playback and click on the left or right side of a picture to display the previous or the next picture.

#### 4.8.10 External File Playback

The external file playback function refers to playback of video files stored in external storage media such as USB flash drive, mobile hard disk or CD-ROM.

The operation steps are as follows:

1. Enter the playback interface and select "External File ", as shown in the figure below.

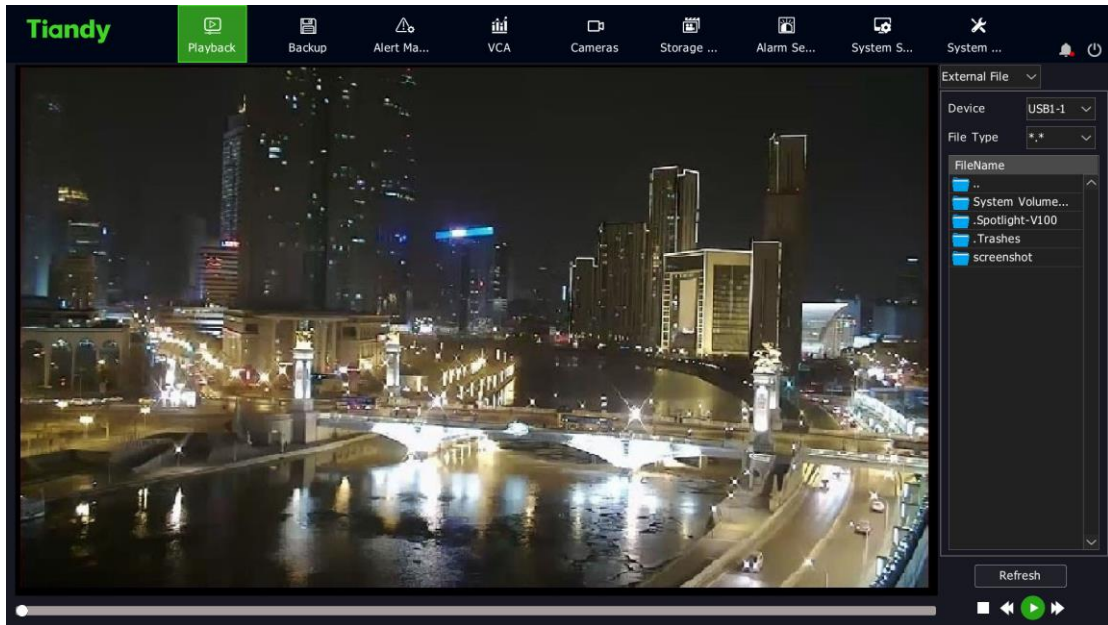

Device type and file type are optional

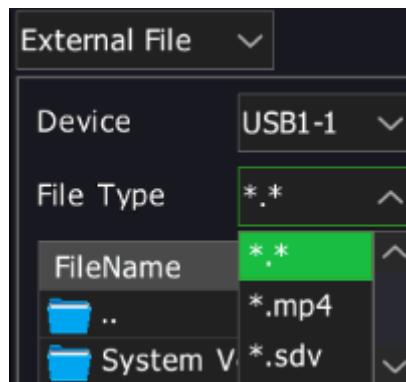

2. Select "Refresh" to read external storage media.

3. Click the file to play to play back external video file, as shown in the figure below.

 **Note:**

- Before playing back external files, make sure that USB flash drive or mobile hard disk or USB drive has been connected to the device.

#### 4.8.11. Log Management

Play the video file corresponding to the log information.

The operation steps are as follows:

- 1、 Select "Main Menu -> System Maintenance -> Log Management" to enter the "Log Management" interface, as shown in the figure below.

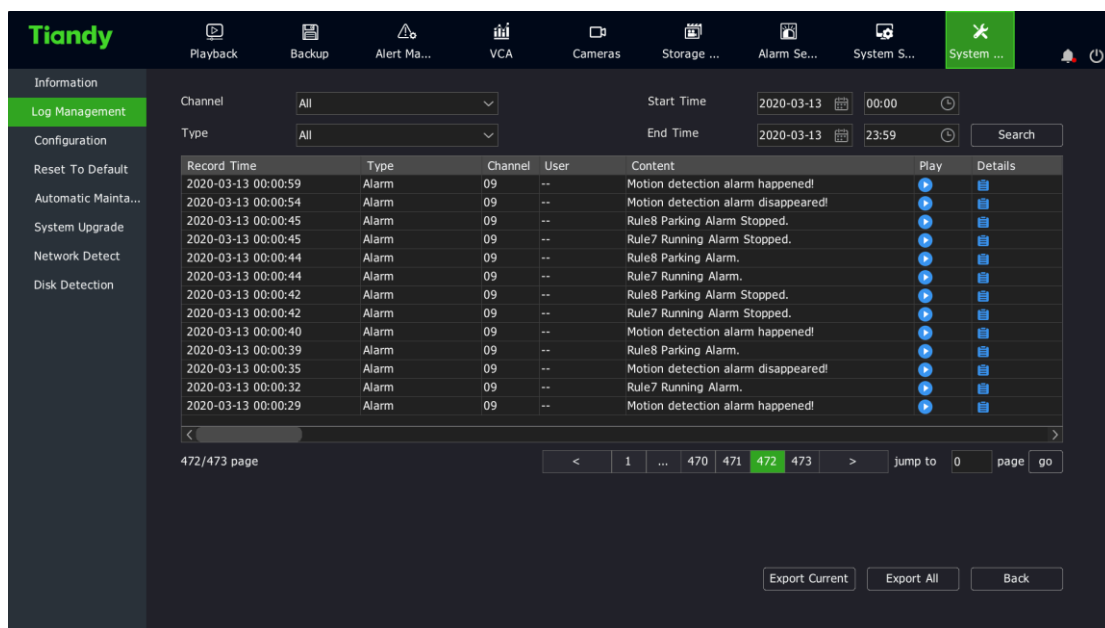

- 2、 Select "Channel" , "Type" , and "Start/End Time" , and click "Search" .

- 3、 Double-click a log in the log list to enter the "Playback" interface, as shown in the figure below.

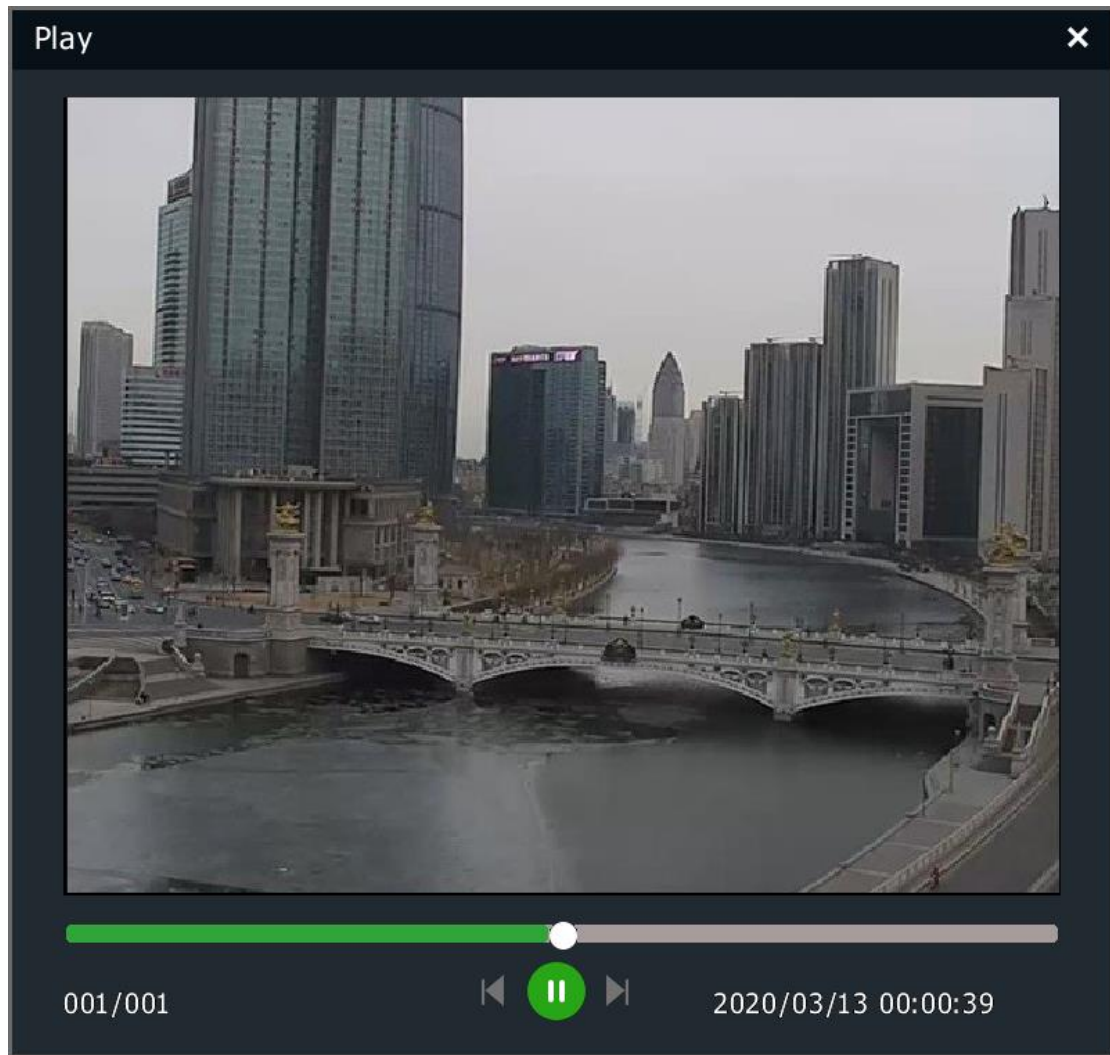





#### Notes:

- The playback progress can be controlled by the playback time bar on the bottom.
- There shall be video files at the channel and time point corresponding to the selected log and these video files can be played.

#### 4.8.12. Playback Assist Function

##### Single-Frame Playback

During video playback, single-frame playback allows checking of the detail change of the screen.

On the playback interface, left-click  or  or adjust the playback speed to "Single Frame". Step forward one frame for each click on the  button, and step back one frame for each click on the  button. The single-frame playback interface is shown in the figure below.

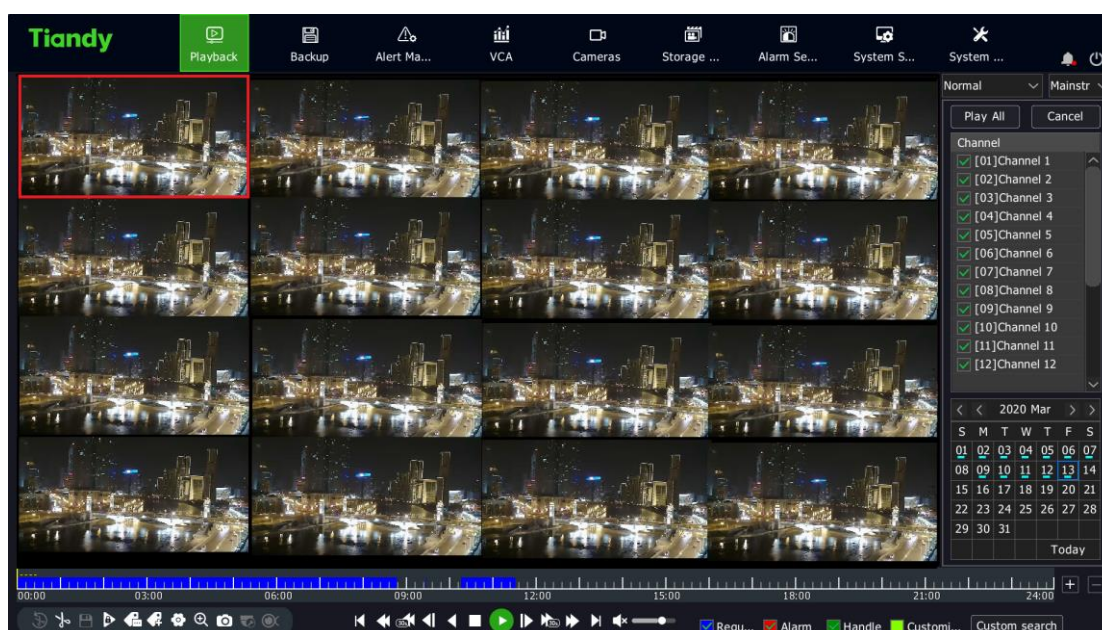

## Digital Zoom

The partial picture of the video is enlarged to the full screen display in the process of playback or playback pause.

The operation steps are as follows:

- 1、 Enter the playback interface.

- 2、 Select the  button on the playback control bar to enter the digital zoom interface.
- 3、 The drag bar on the top left or your mouse wheel can be used to adjust the zoom factor.
- 4、 Press and hold and drag the left mouse button to see different areas.



### Snapshot

Snapshot in the process of video playback.

The operation steps are as follows:

- 1、 Enter the playback interface.
- 2、 Select a screen and click the  button on the playback control bar.

 **Note:**

- Images captured during playback need to be saved on a USB flash drive. When carrying out the snapshot operation, make sure the USB flash drive is correctly connected to the device.

### **Progress Bar Preview**

On the playback interface, when playback mode is selected as regular playback, event playback, or label playback, and single screen is selected, the system will automatically display the time point and the images before and after the time point when your mouse slides over the play progress bar. The operation steps are as follows:

- 1、 Select playback mode as one of the above and start playback.
- 2、 Hover your mouse over a section of the progress bar that has video footage, and a preview image will appear, as shown in the figure below.
- 3、 Click any of small screens, and then locate to the time point to play.



## Notes:

- The progress bar preview operation is impossible when the decoding performance reaches the upper limit.
- The progress bar preview operation is impossible on the current channel when no video is available at the selected time point.
- No progress bar preview is available for non-single screen.

## Quick Drag to Play

When playing on a single screen, you can quickly drag the progress bar. In this case, the progress bar will be dragged to play video quickly to facilitate viewing.

## 4.9 Backup

Backup allows backing up of video files in the system to the backup disk or USB storage device (USB, mobile hard disk, esata).



1. Select "Main Menu -> Backup" to enter the backup interface, as shown in the figure below.

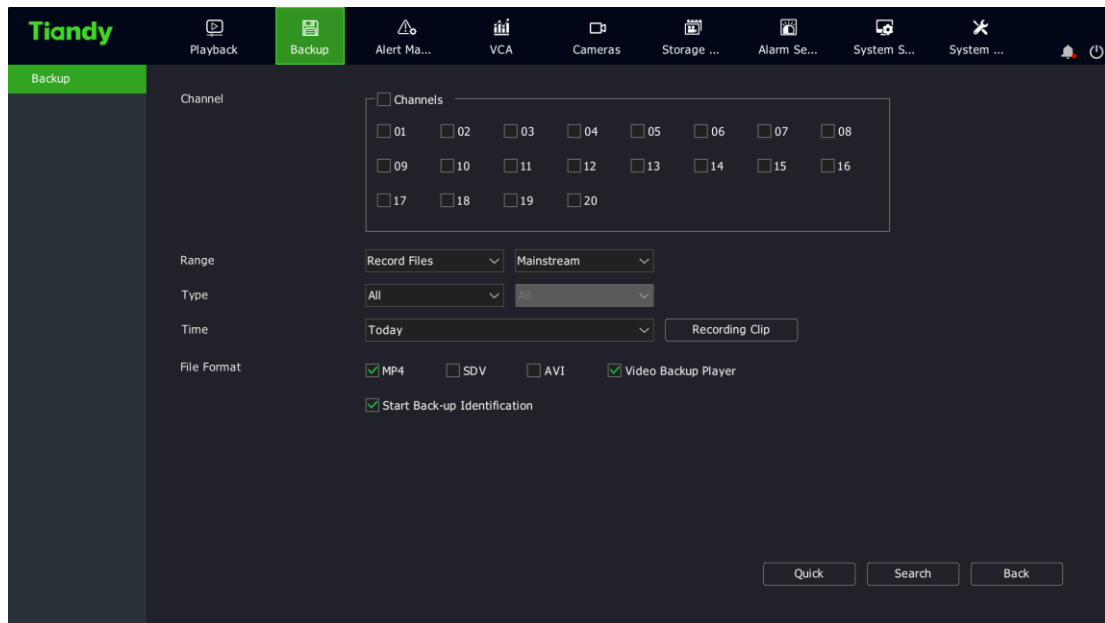

2. Click "Video Snapshot" to visually display recordings of the specified date. After the date is selected, click "OK" to help the user select the start and end time of video querying according to the date. After returning to the interface in step 1, you can check it from "Start Date" , "Start Time" , "End Date" , and "End Time" .



 **Note:**

- Image files do not support video snapshot.

3. After identifying the query conditions, if "Enable Backup Authentication" is checked, click on "Backup" or "Query Backup" button will display the authentication form. You need to conduct authentication first before proceeding to the next step.

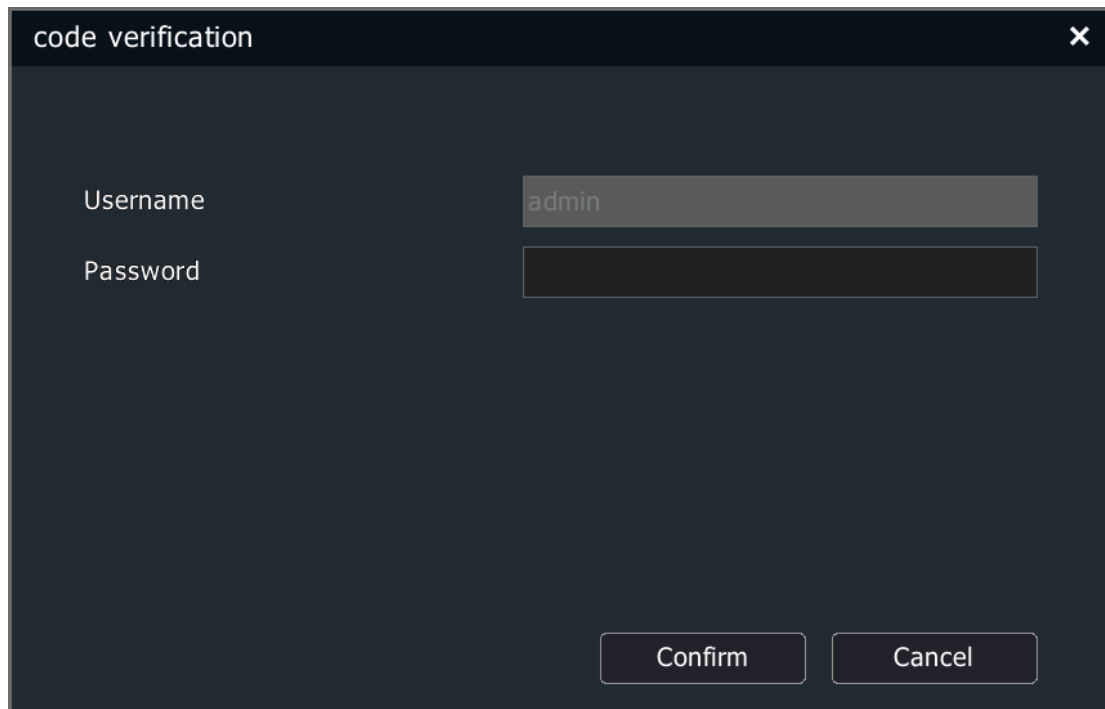
A dark-themed dialog box titled "code verification" with a close button (X) in the top right corner. It contains two input fields: "Username" with the text "admin" and "Password" which is currently empty. At the bottom, there are two buttons: "Confirm" and "Cancel".

code verification

Username admin

Password

Confirm Cancel

4. After identifying the query conditions, click the "Backup" button. If the backup destination is a USB storage device, it will enter the backup interface where you can select the destination folder for backup. If the backup destination is a backup disk, then proceed to the backup operation directly.

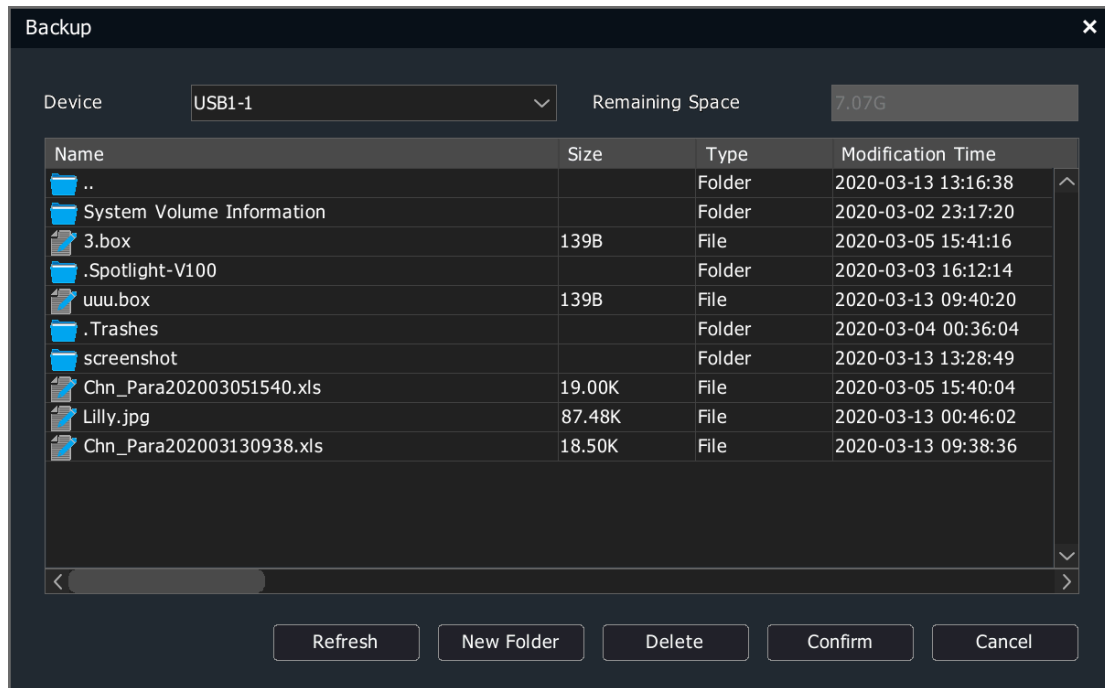

5. After identifying the query conditions, click the "Query Backup" button for video file querying.

The video query results are presented in a list or a chart manner.

**List:**

To play the file, click the "Playback" icon or double-click the line where the file is located.

Click the "Lock" icon to lock and unlock the file.

Backup

Chart **List**

Channel	StartTime	StopTime	Size	Type	Playback	Lock
<input type="checkbox"/> 9	2020-03-12 23:04:50	2020-03-13 00:01:57	1018.65M	Schedule		
<input type="checkbox"/> 3	2020-03-12 23:12:15	2020-03-13 00:18:00	1018.67M	Schedule		
<input type="checkbox"/> 4	2020-03-12 23:15:28	2020-03-13 00:19:43	1018.81M	Schedule		
<input type="checkbox"/> 2	2020-03-12 23:59:03	2020-03-13 00:07:29	1018.65M	Schedule		
<input type="checkbox"/> 9	2020-03-13 00:01:57	2020-03-13 00:58:59	1018.64M	Schedule		
<input type="checkbox"/> 2	2020-03-13 00:07:30	2020-03-13 00:15:57	1018.66M	Schedule		
<input type="checkbox"/> 2	2020-03-13 00:15:57	2020-03-13 00:24:24	1018.69M	Schedule		
<input type="checkbox"/> 3	2020-03-13 00:18:00	2020-03-13 01:23:43	1018.65M	Schedule		
<input type="checkbox"/> 4	2020-03-13 00:19:43	2020-03-13 01:23:49	1018.74M	Schedule		
<input type="checkbox"/> 2	2020-03-13 00:24:24	2020-03-13 00:32:51	1018.86M	Schedule		
<input type="checkbox"/> 2	2020-03-13 00:32:51	2020-03-13 00:41:18	1018.73M	Schedule		
<input type="checkbox"/> 2	2020-03-13 00:41:18	2020-03-13 00:49:45	1018.63M	Schedule		
<input type="checkbox"/> 2	2020-03-13 00:49:45	2020-03-13 00:58:12	1018.68M	Schedule		
<input type="checkbox"/> 2	2020-03-13 00:58:12	2020-03-13 01:06:39	1018.72M	Schedule		
<input type="checkbox"/> 9	2020-03-13 00:59:00	2020-03-13 01:56:04	1018.64M	Schedule		
<input type="checkbox"/> 2	2020-03-13 01:06:40	2020-03-13 01:15:07	1018.75M	Schedule		
<input type="checkbox"/> 2	2020-03-13 01:15:07	2020-03-13 01:23:34	1018.70M	Schedule		
<input type="checkbox"/> 2	2020-03-13 01:23:34	2020-03-13 01:32:01	1018.69M	Schedule		
<input type="checkbox"/> 3	2020-03-13 01:23:43	2020-03-13 02:29:27	1018.71M	Schedule		
<input type="checkbox"/> 4	2020-03-13 01:23:49	2020-03-13 02:28:02	1018.65M	Schedule		
<input type="checkbox"/> 2	2020-03-13 01:32:01	2020-03-13 01:40:28	1018.70M	Schedule		
<input type="checkbox"/> 2	2020-03-13 01:40:28	2020-03-13 01:48:55	1019.03M	Schedule		

1/6 page  
Total:0B

1 2 3 4 5 6 > jump to 0 page go

Backup Back

### Chart:

Click to select a certain screen to play the 10s video after the time point. Double-click the preview image to play it back.

Backup

Chart **List**

SelectAll

Channel 20 Channel 8 Channel 7 Channel 19 Channel 11

Channel 16 Channel 17 Channel 8 Channel 7 Channel 17

Channel 20 Channel 7 Channel 19 Channel 11 Channel 8

1/9 page  
Total:0B

1 2 3 4 ... 9 > jump to 0 page go

Backup Back

6. Select the video file to back up from the list or chart, and click the "Backup" button to enter the backup screen.

## 4.10. System Maintenance

### 4.10.1 Information

#### System Information

1. Select "Main Menu -> System Maintenance -> Information -> System Information" to enter the system information interface, as shown in the figure below.

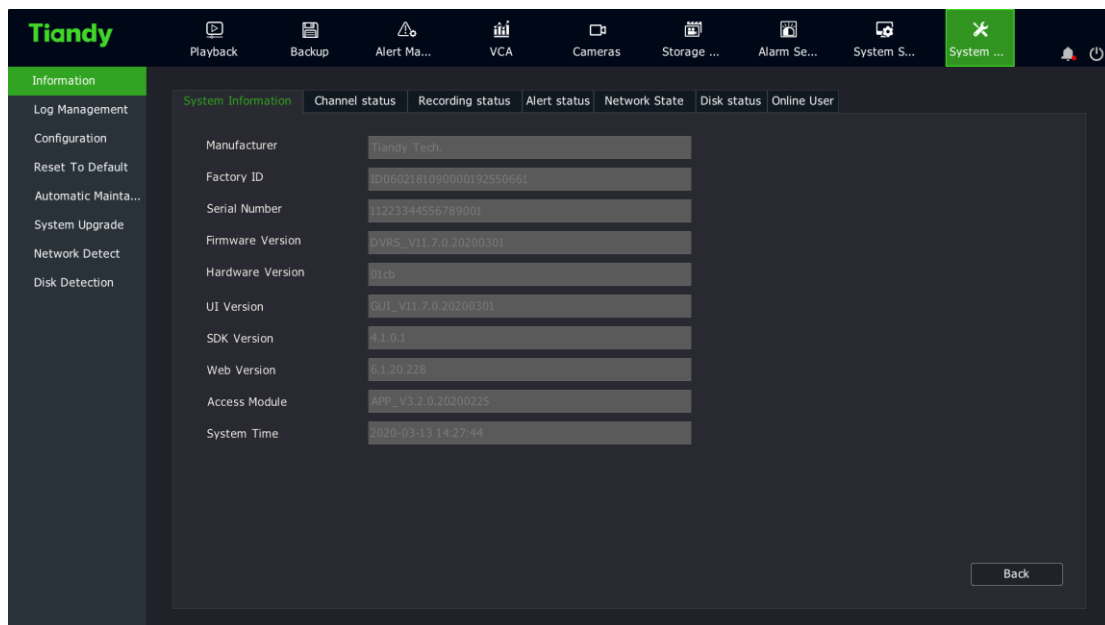

2. The manufacturer, serial number, kernel version, hardware version, SDK version, webpage version, UI version, and system time can be checked under System Info.

#### Channel Status

1. Select "Main Menu -> System Maintenance -> Information -> Channel Status" to enter the channel status interface, as shown in the figure below.

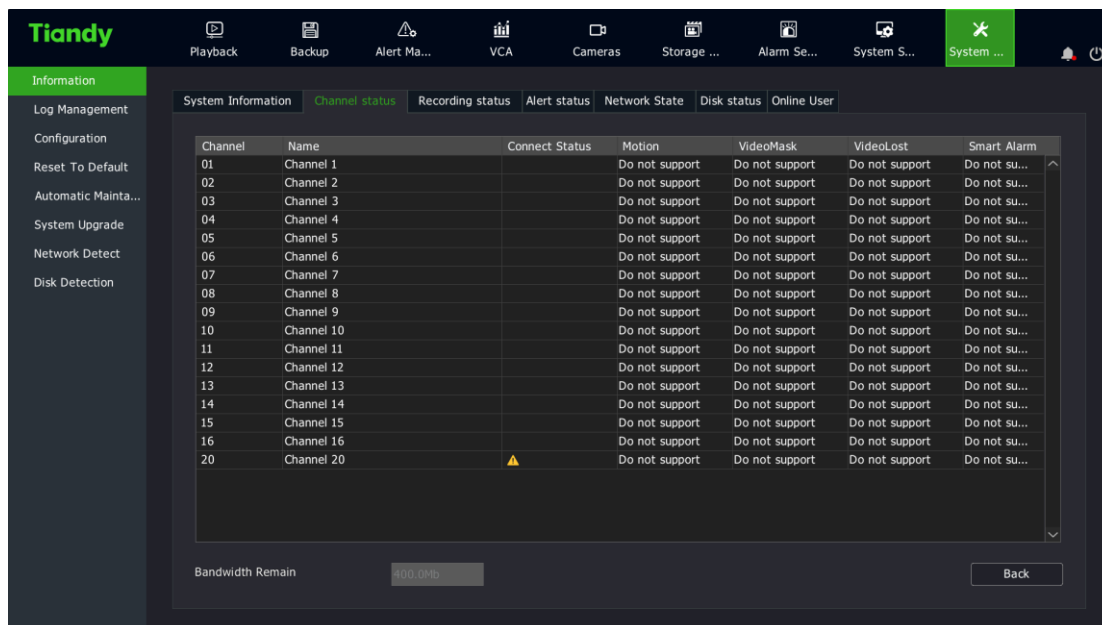

2. Channel number, channel name, connection status, motion detection status, video occlusion status and video loss status can be checked under Channel Status.

### Note:

- Devices not supporting video occlusion alarm function will not display the video occlusion column on the screen.

### Record Status

1. Select "Main Menu -> System Maintenance -> Information -> Recording Status" to enter the record status interface, as shown in the figure below.

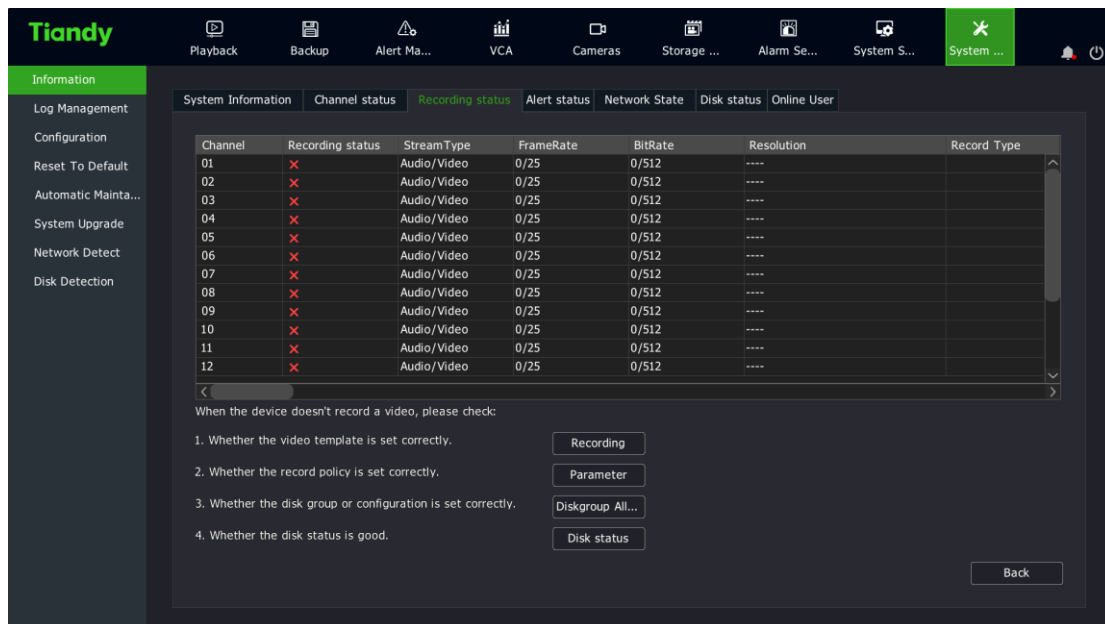

5、 Channel number, recording status, stream type, real-time frame rate/set frame rate, real-time bitrate/set bitrate, video resolution, video type, compression parameters, redundancy status can be checked under Record Status.

6、 When you click video template, video strategy and disk page setting, the HDD status can jump to the corresponding interface to view the device configuration status.

## Alert Status

1. Select "Main Menu -> System Maintenance -> Information -> Alert Status" to enter the alarm status interface, as shown in the figure below.



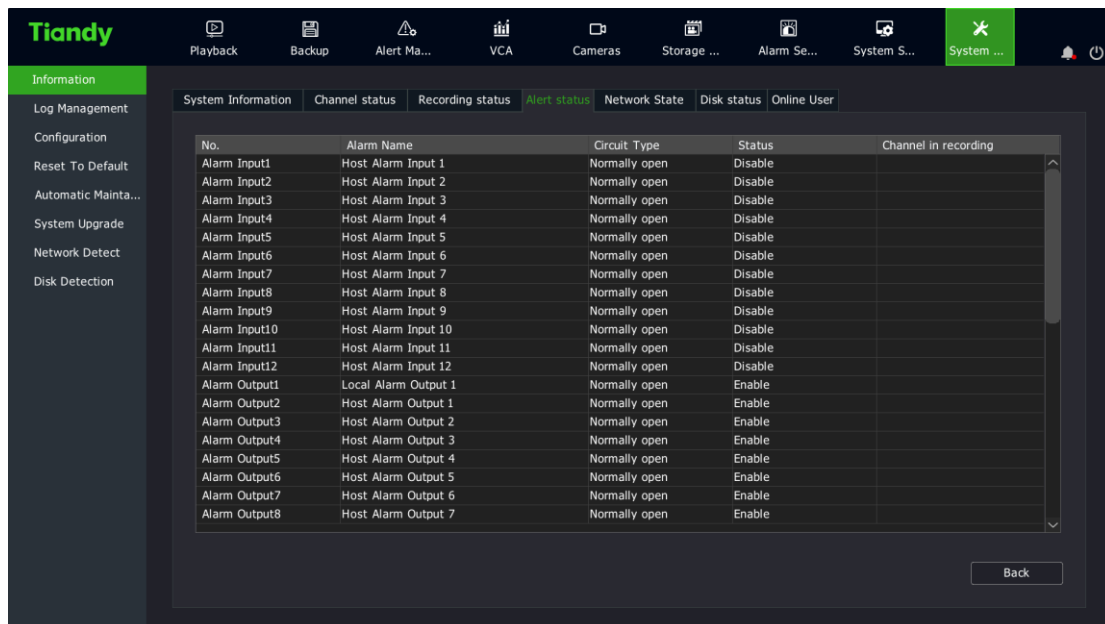

2. Serial number, name, annunciator type, ON/OFF status, channel triggering of the local alarm and alarm host can be checked under Alarm Status.

## Network State

1. Select "Main Menu -> System Maintenance -> Information -> Network State" to enter the network status interface, as shown in the figure below.

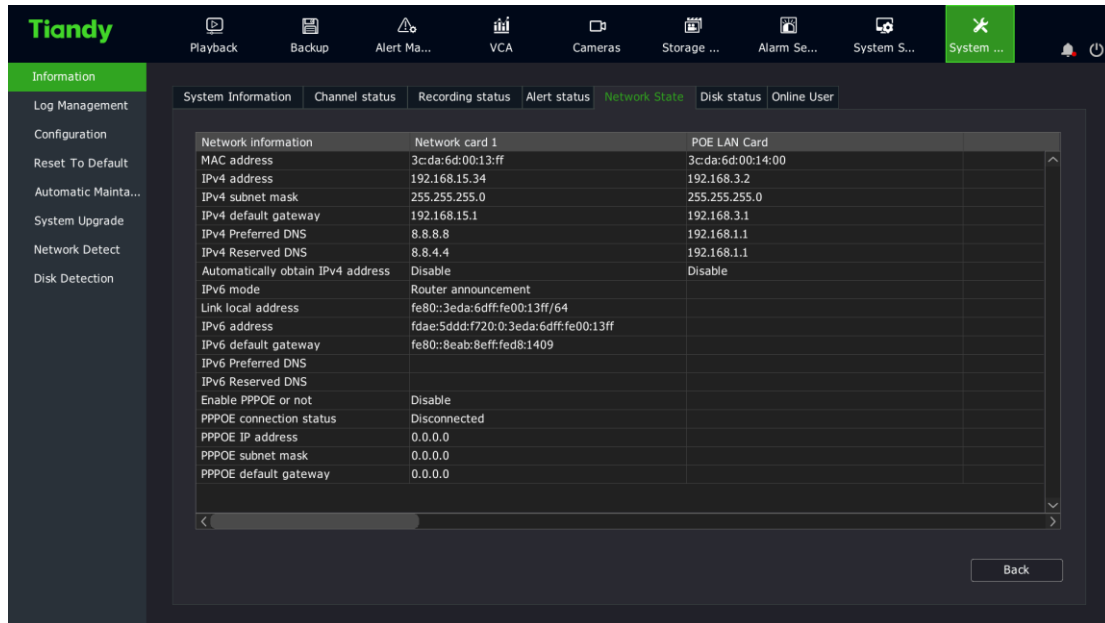

2. Network card-related network information can be checked under Network Status.

 **Note:**

- Devices not supporting dual network cards will not display the network card 2 column on the screen.

### Disk Status

1. Select "Main Menu -> System Maintenance -> Information -> Disk Status" to enter the HDD status interface, as shown in the figure below.

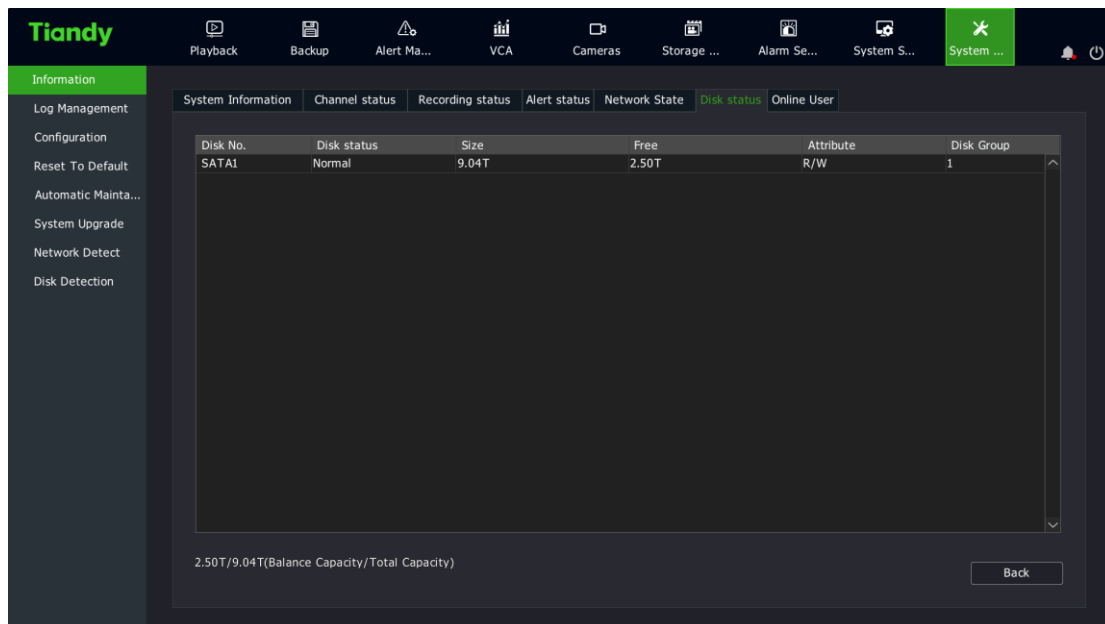

2. HDD number, SMART detection status, size, idle, property, disk pack, total remaining capacity and total capacity of all hard disks can be checked under HDD status.

## Online User

1. Select "Main Menu -> System Maintenance -> Information -> Online User" to enter the online users interface, as shown in the figure below.

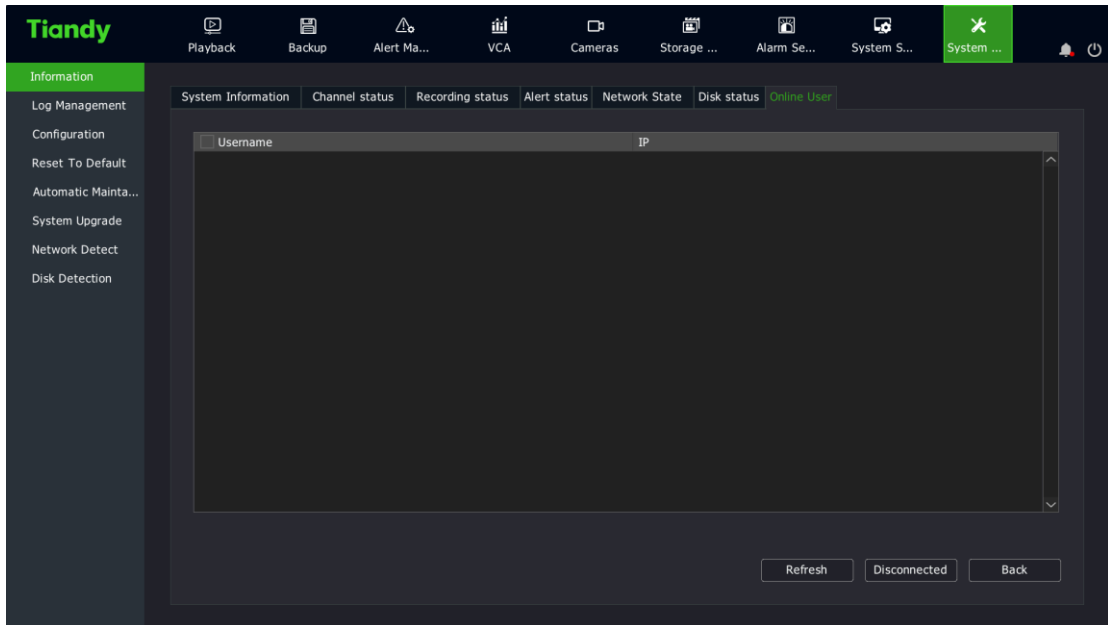

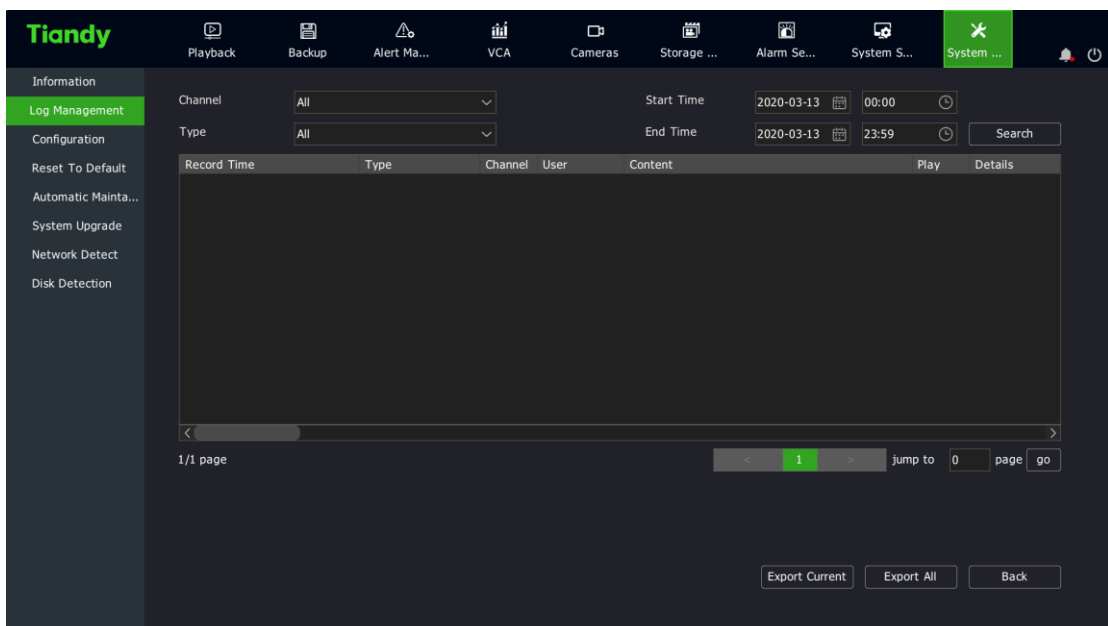

## 4.10.2 Log Management

1. Select "Main Menu -> System Maintenance -> Log Management" to enter the log querying interface, as shown in the figure below.



2. After selecting query conditions such as channel, type, start and end times, click "Query" button for log querying.

3. After logs are obtained, you can use the button to select the previous page or next page to view the logs, or input the number of pages. Click OK to jump to the page, select the log and click  to check log details. Select alarm logs and click  to preview the video in the alarm time period.

#### 4. Log export operation:

1) To export the current page: After querying the log, click "Export Current Page" to display the following form. Select the path and click "OK" to backup the log on the currently viewed page to the specified path.

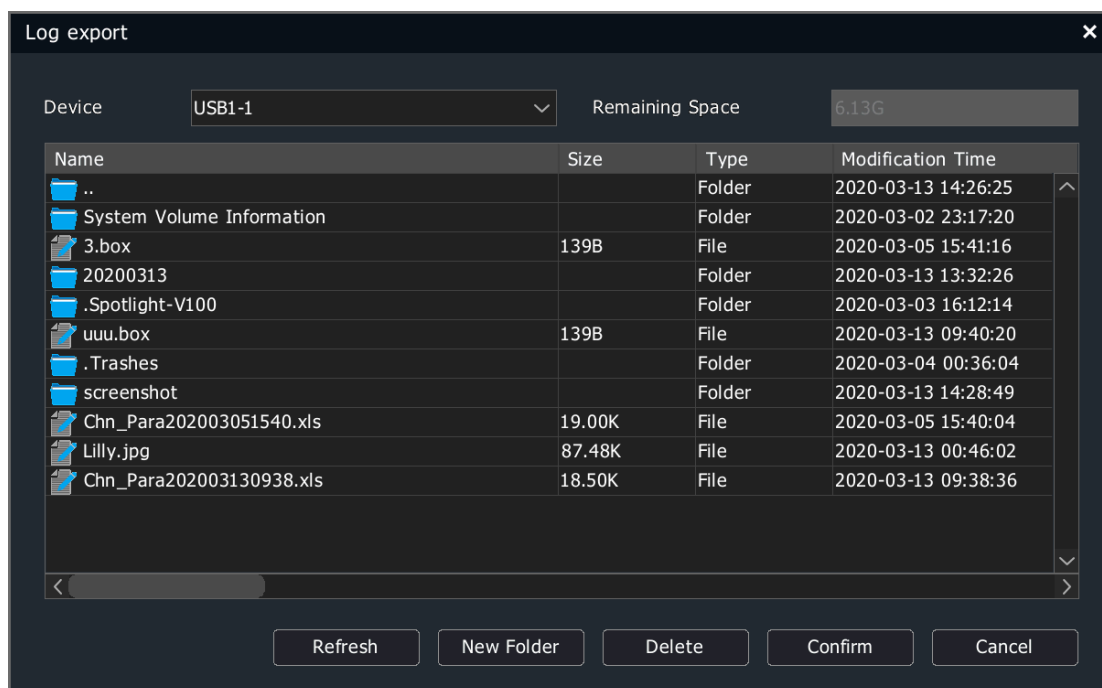

2) To export all pages: Click "Export All Pages" to export all the logs that have been obtained. The backup path operation is the same as above.

### 4.10.3 Configuration

#### Configuration Export

1. Select "Main Menu -> System Maintenance -> Configuration -> Configuration Export" to enter the config export interface, as shown in the figure below. Performing the "Export" operation on configuration files of the device will facilitate timely backup of configuration file.

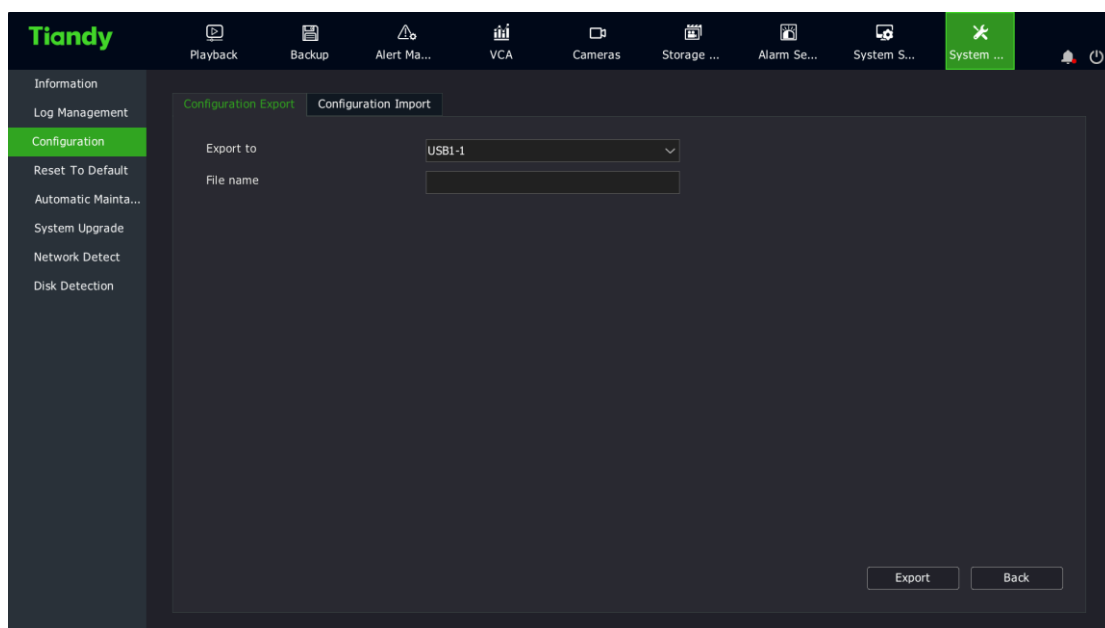

2. Select Config Export and add the export file name and destination to export device configurations.

#### Configuration Import

1. Select "Main Menu -> System Maintenance -> Configuration -> Configuration Import" for import operation. If the same configuration is

used for multiple devices, the "Import" operation will allow saving device configuration time.

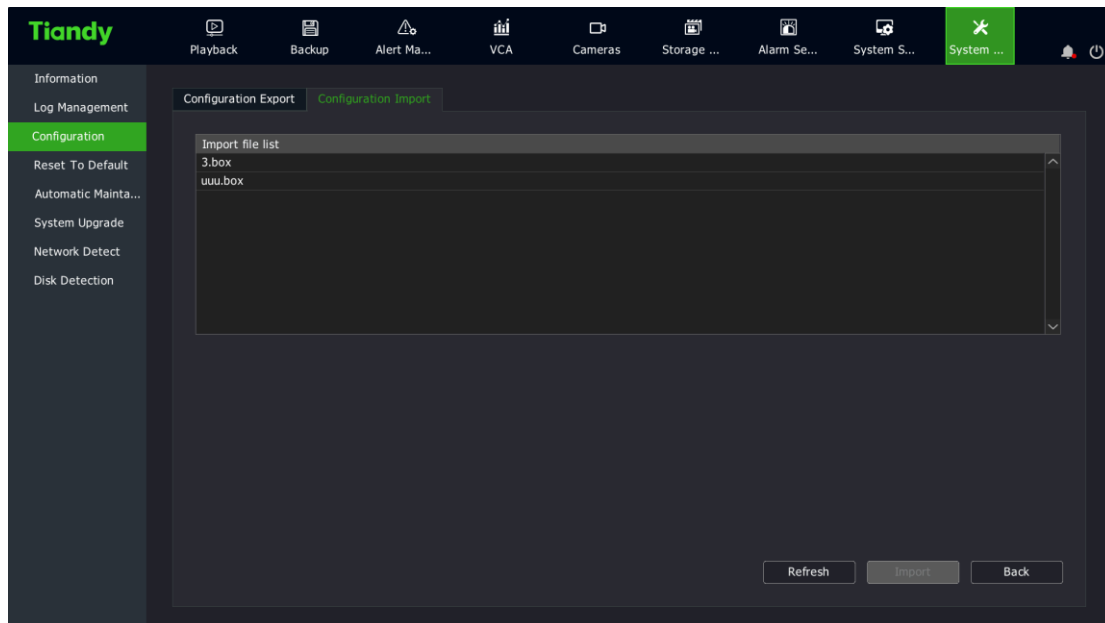

#### Note:

- 1) The device will restart automatically after successful import.

### 4.10.4 Reset To Default

#### Reset To Default

1. Select "Main Menu -> System Maintenance -> Reset To Default " to enter the restore defaults interface, as shown in the figure below.

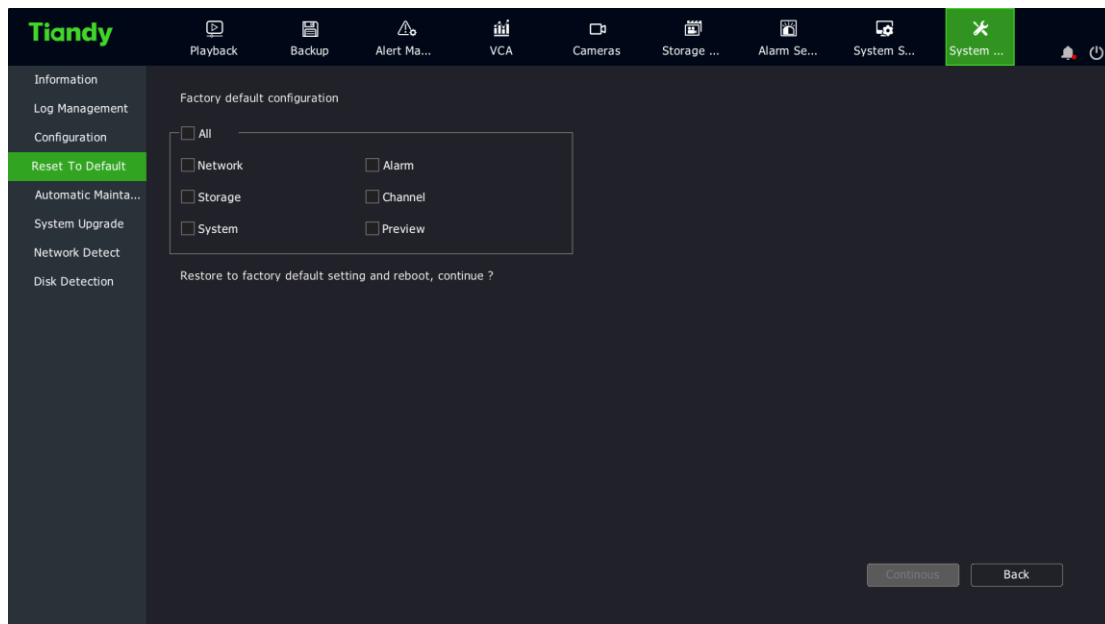

2. The users can select the module to restore defaults according to their own needs. Click the "Continue" button, and the selected module will be restored to default configurations.



**Note:**

- The device will restart automatically after restoring the defaults.

#### 4.10.5 Automatic Maintenance

1. Select "Main Menu -> System Maintenance -> Automatic Maintenance -> Device Maintenance" to enter the device maintenance setting interface, as shown in the figure below, where you can set the device name, number and automatic restart time.



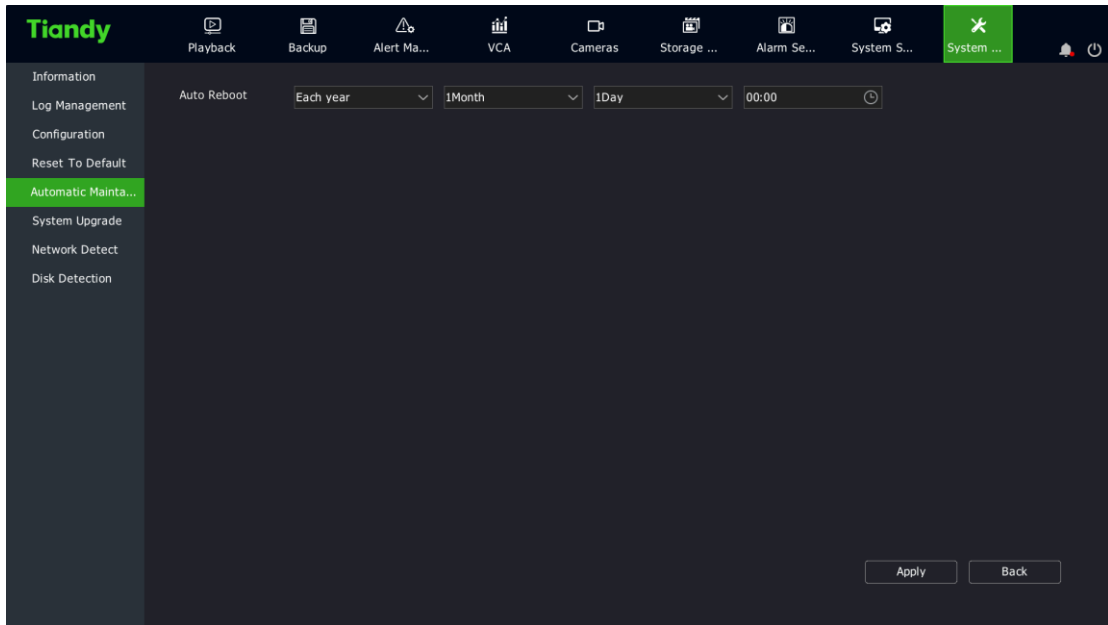

#### 4.10.6. System Upgrade

1. Select "Main Menu -> System Maintenance -> System Upgrade -> Cloud Upgrade" to enter the cloud upgrade interface, as shown in the figure below.

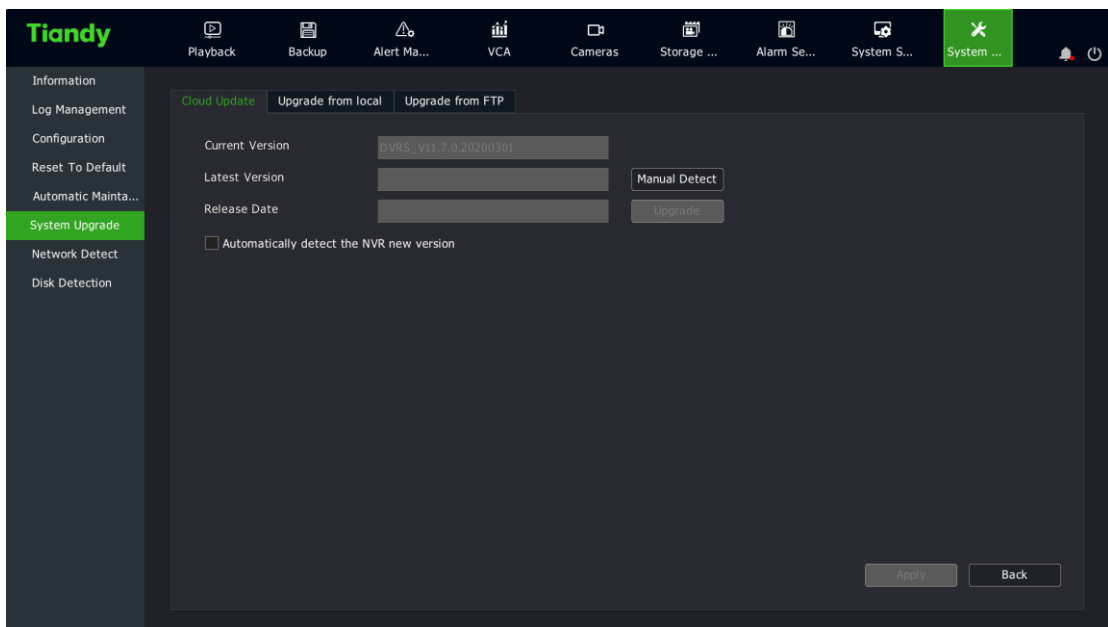

Click Manual Detection to check whether there is the latest version available. If there is a new version available, click Upgrade to upgrade to the new version.

- 1、 Select "Main Menu -> System Maintenance -> System Upgrade -> Upgrade from local" to enter the local file upgrade interface, as shown in the figure below.

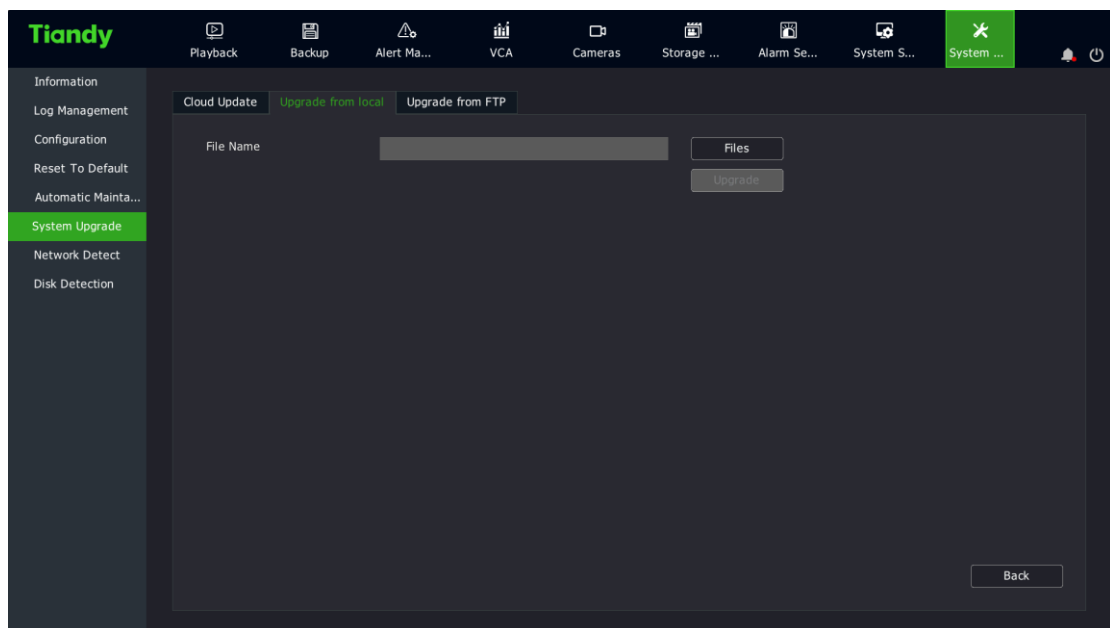

- 2、 Click Browse to select the file you want to upgrade, and then upgrade it, as shown in the figure below.

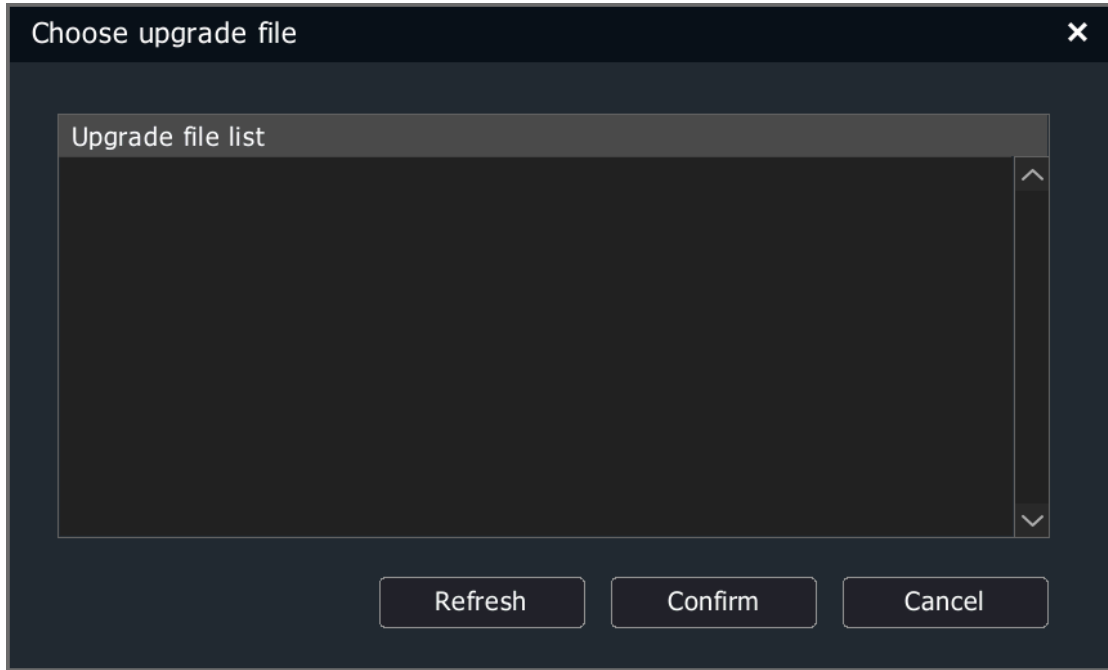

3、 Select "Main Menu -> System Maintenance -> System Upgrade -> Upgrade from FTP" to enter the FTP upgrade interface, as shown in the figure below.

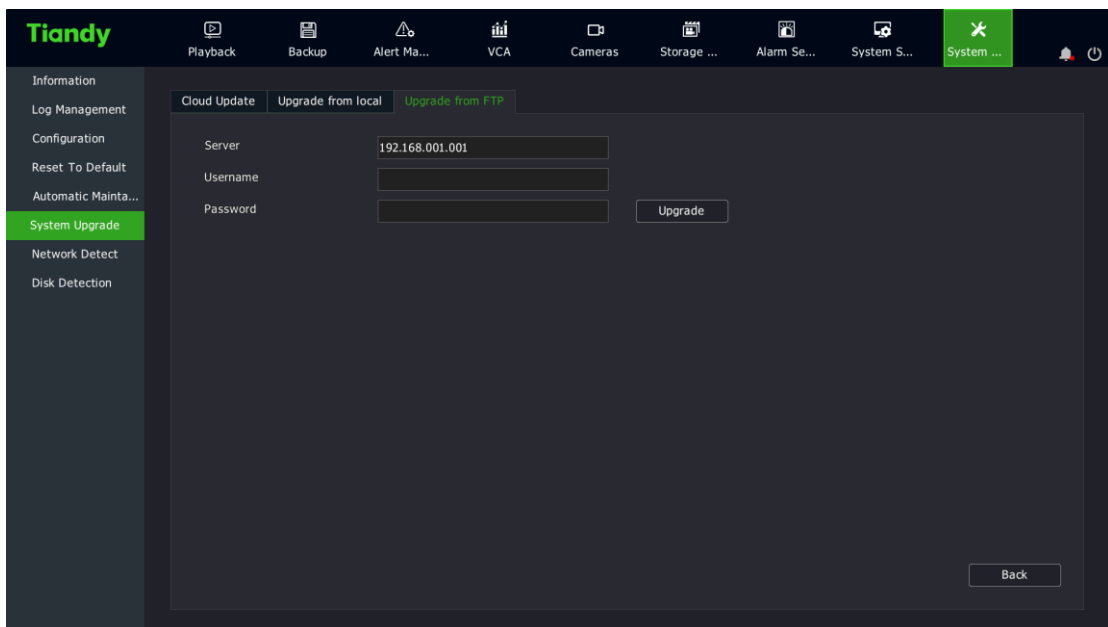

 **Note:**

- After the upgrade is successful, the device will automatically restart and the new version comes into effect after restart.
- If it is suggested that the upgrade fails or the equipment cannot operate normally after restart, please contact your vendor for solutions.

#### 4.10.7 Network Detect

### Network Detect

1. Select "Main Menu -> System Maintenance -> Network Detect -> Packet Backup" to enter the packet snapshot backup interface, as shown in the figure below.

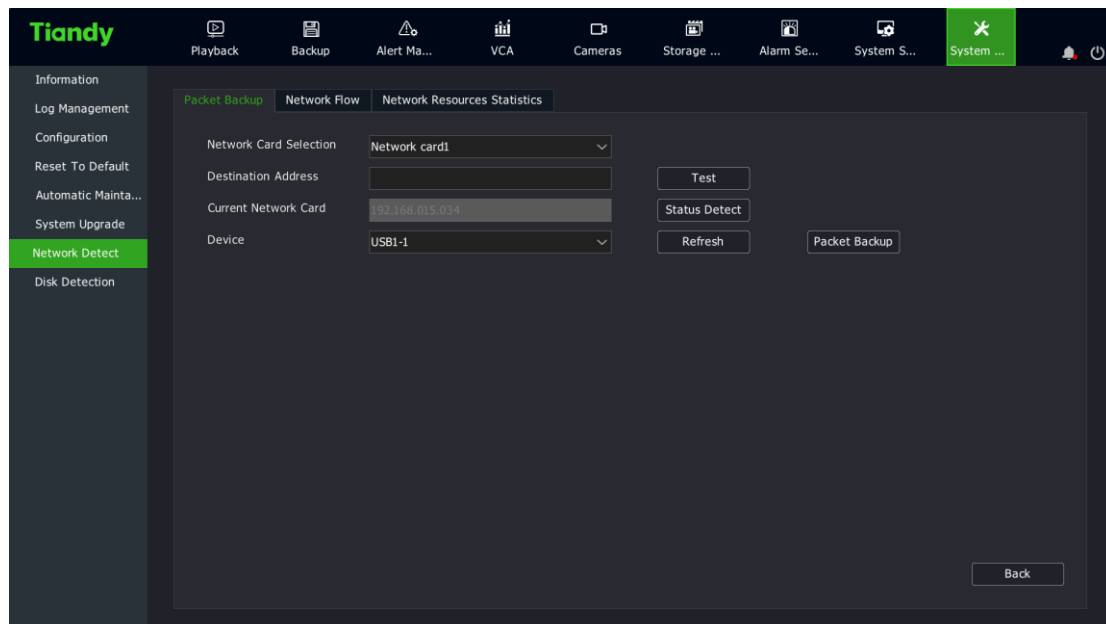

2. In the network testing field, enter the destination address to test whether the address can be pinged through.

3. Click the "Packet Snapshot Backup" button to capture the current network card and save it to the specified storage medium.

4. Click the "Status Detection" button to check whether the gateway and DNS of the current network card are accessible.

5. Select the "Main Menu -> System Maintenance -> Network Detect -> Network Flow" interface to view and display real-time network data, as shown in the figure below.

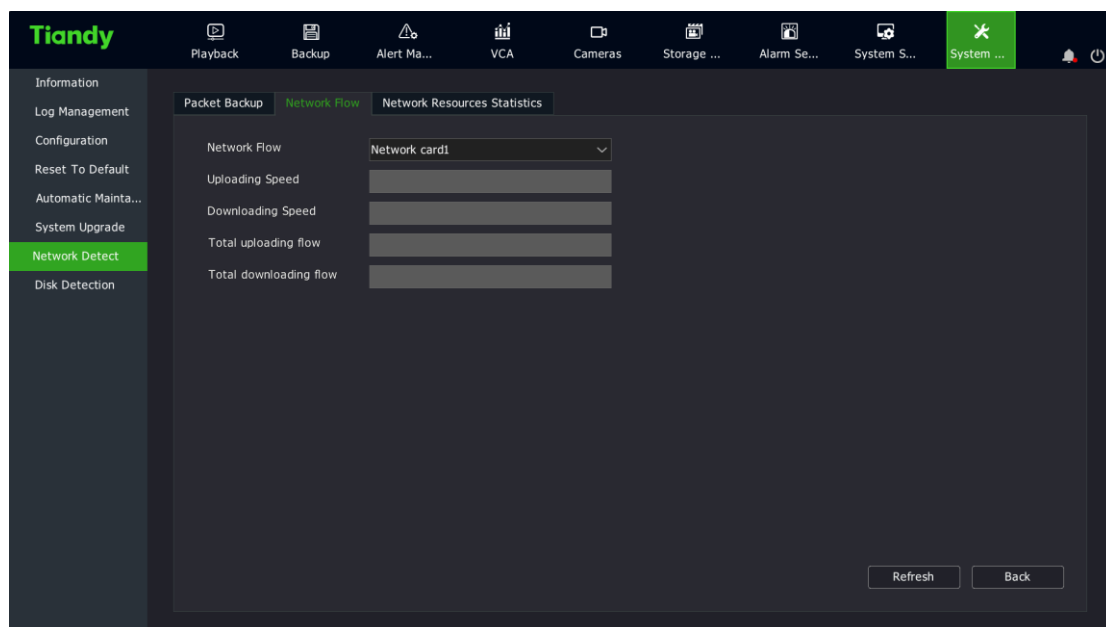

6. Select the "Main Menu -> System Maintenance -> Network Detect -> Network Resource Statistics" interface to check the usage of network resources, as shown in the figure below.

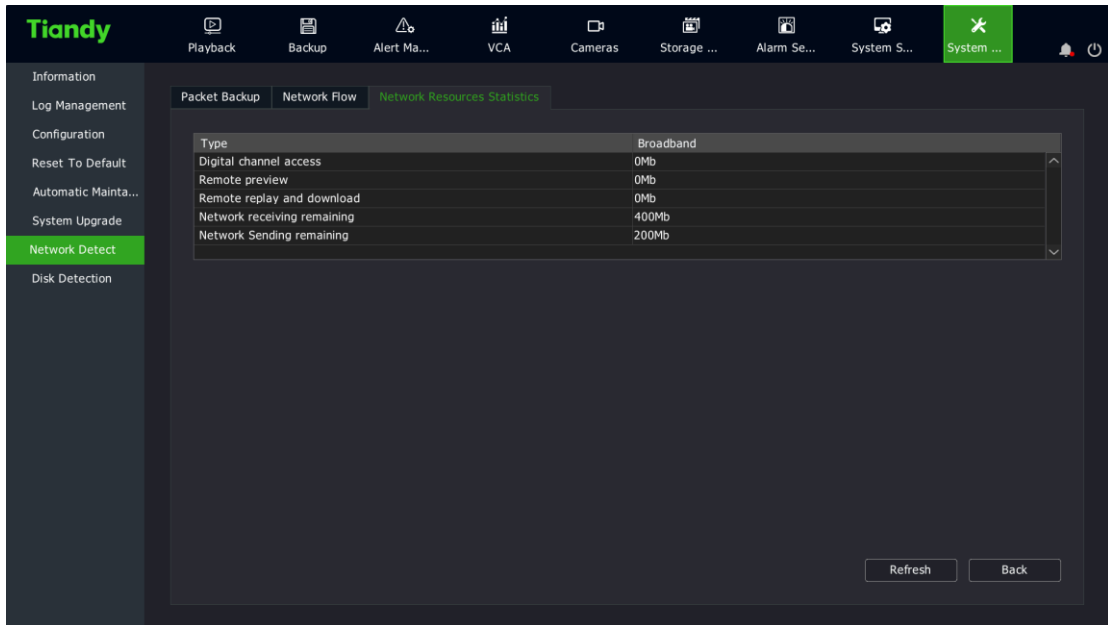

#### 4.10.8. Disk Detection

##### S.M.A.R.T.

1. Select "Main Menu -> System Maintenance -> Disk Detection -> S.M.A.R.T." to enter the SMART setting interface.

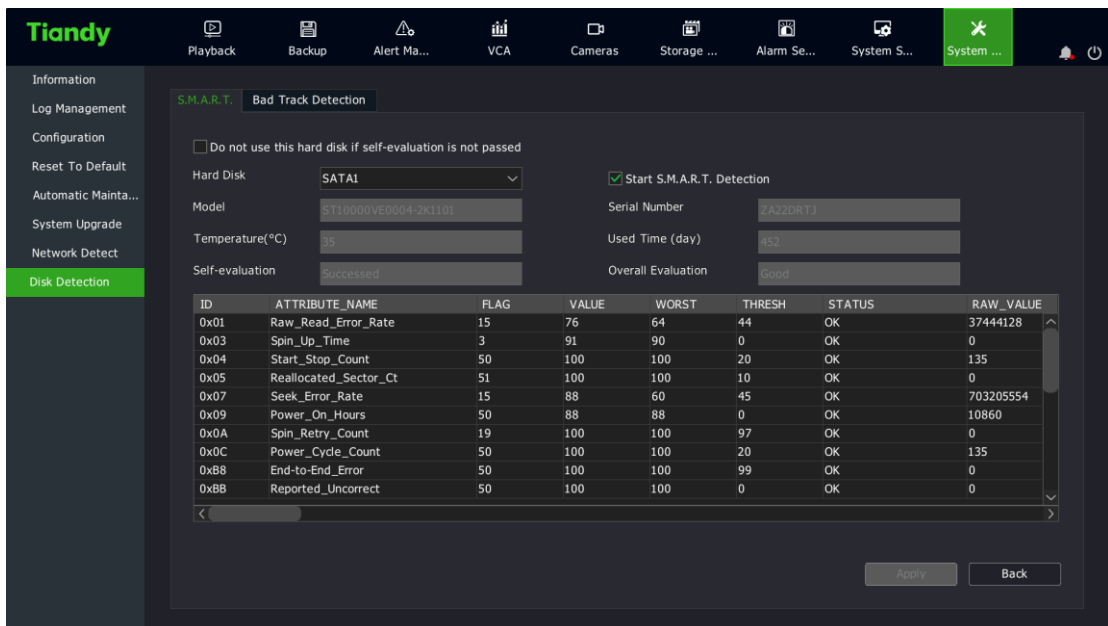

2. Select the disk to detect and check "Enable S.M.A.R.T Detection" to enable the S.M.A.R.T detection function of the disk. S.M.A.R.T detection information is displayed in the corresponding interface.

3. When "Do not use the HDD when it fails self-assessment", do not use the HDD if there is any problem with the self-assessment after the S.M.A.R.T test.

## Bad Track Detection

1. Select "Main Menu -> System Maintenance -> Disk Detection -> Bad Track Detection" to enter the bad track detection interface.

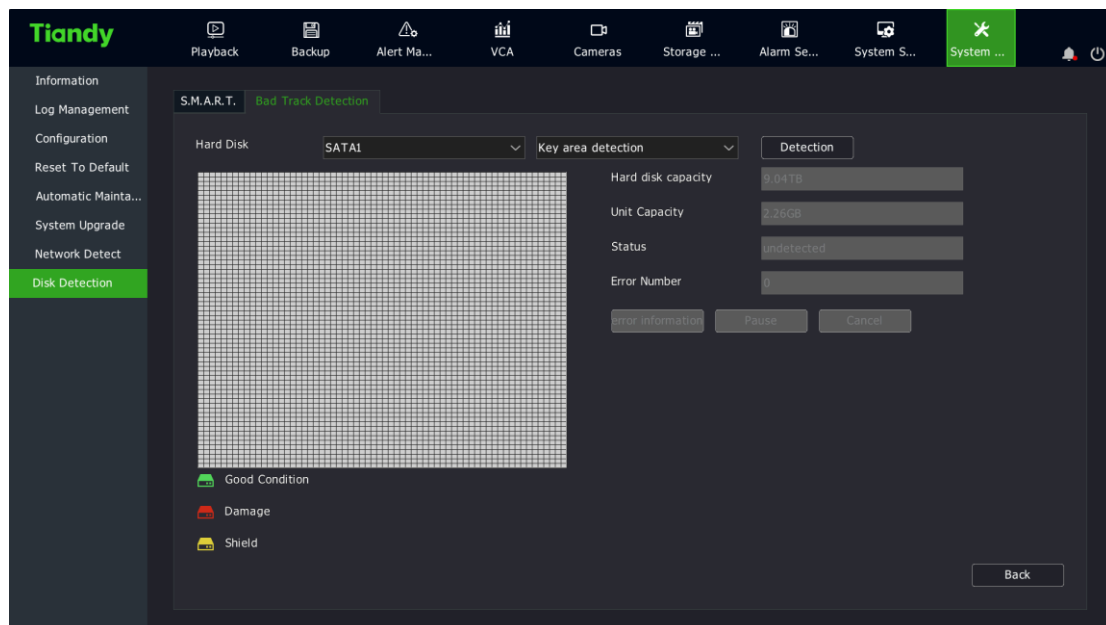

2. Select the hard disk and detection method and click the Detection button to enter the detection status.

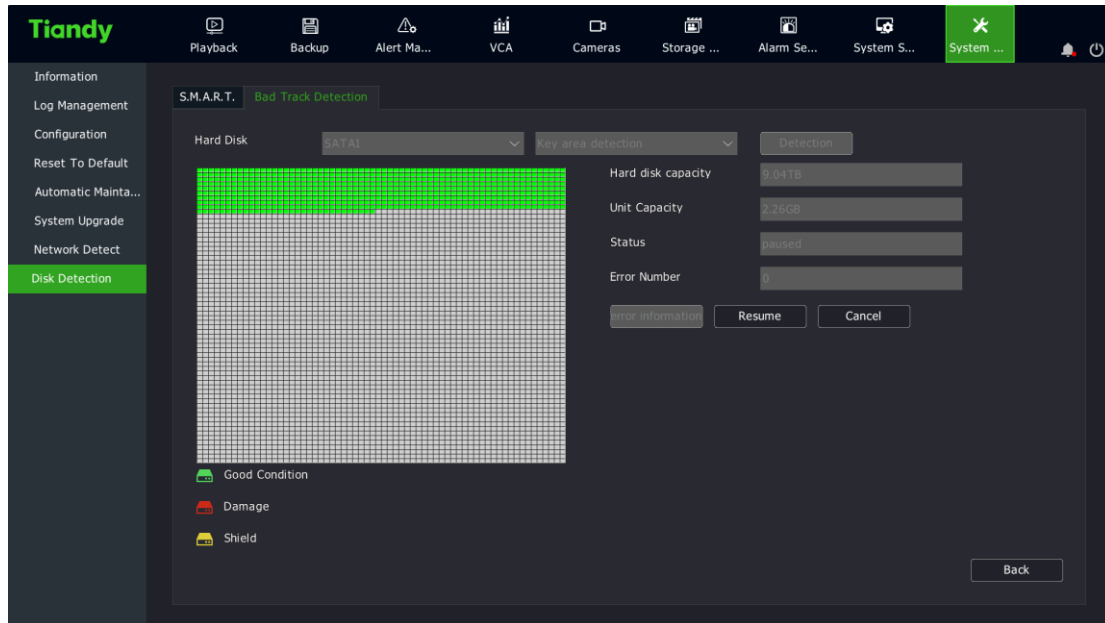

3. Click Pause to suspend the bad track detection; Click Restore to resume the bad track detection;

4. Click Cancel to cancel the bad track detection;

5. Click the Error Message button to check the bad track of the hard disk.



**Note:**

- The Error Message button is available only if the number of errors on the hard disk is greater than 0.
- When the number of errors on the hard disk is 100, bad trace detection stops.



" means the corresponding area of the hard disk is in good



condition," means the corresponding area of the hard disk is



damaged,"  "means the corresponding area of the hard disk is shielded.

## 4.11. System Setting

For unified management of device attributes in the system.

### 4.11.1 General Setting

#### Basic Setting

1. Select "Main Menu -> System Setting -> General Setting -> Basic Setting" to enter the basic setting interface, as shown in the figure below, where you can set the local output display parameters of the device.

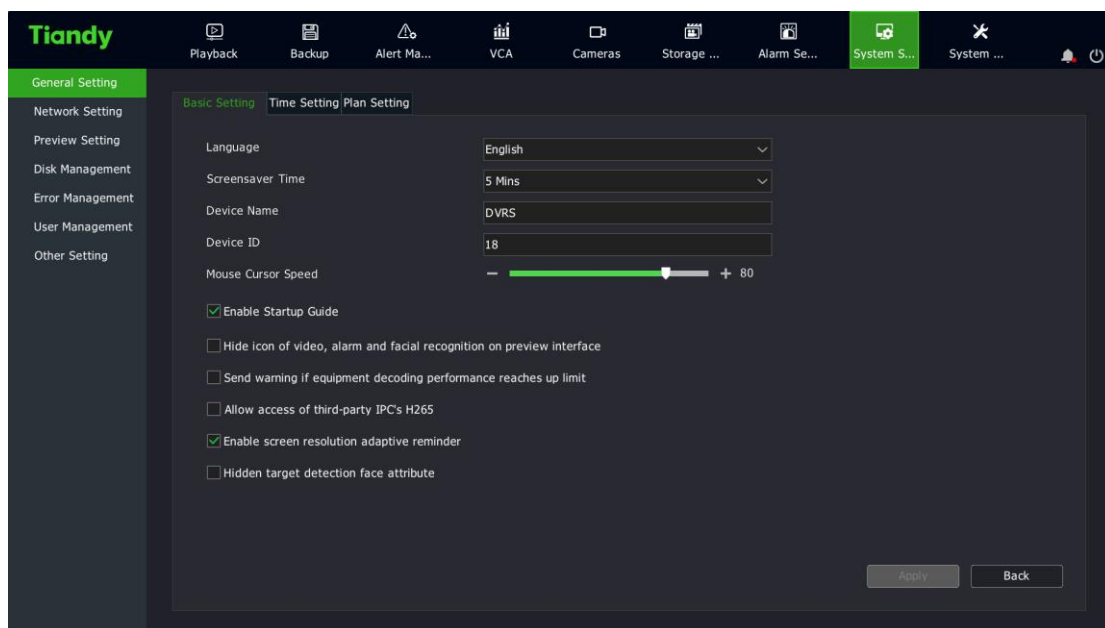

#### Note:

- Language: Selects the system language.

- Screensaver Time: Selects the interface timeout time.
- Enable Startup Guided: Selects whether to enable boot wizard settings.
- Buzzer when pressing button: Turns on the buzzer.
- Hide icon of video, alarm and facial recognition on preview interface: Selects whether to display video, alarm, face recognition icons on the preview interface.
- Send warning if equipment decoding performance reaches upper limit: Selects whether to display the prompt message when the decoding performance reaches the upper limit.
- Mouse Cursor speed: Selects the mouse movement speed, 0-100 adjustable.

## **Time Setting**

1. Select "Main Menu -> System Setting -> General Setting -> Time Setting" to enter the time setting interface, as shown in the figure below, where you can set system time, time zone, and NTP timing parameters.

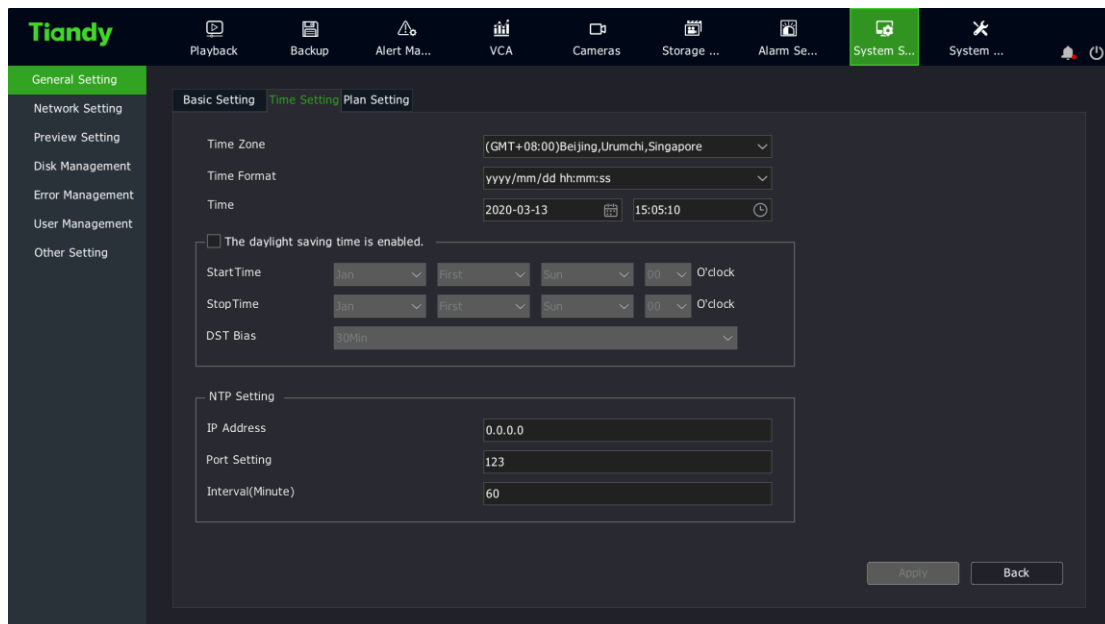

## Plan Setting

1. Select "Main Menu -> System Setting -> General Setting -> Plan Setting" to enter the preplan setting interface, as shown in the figure below. When an alarm situation occurs, the linkage preplan is displayed on the preview interface, and the on-duty personnel shall deal with it according to the preplan, such as alarming, notification, asking for helps, etc.
2. Click the preplan name or preplan content to directly edit them, as shown in the figure below.

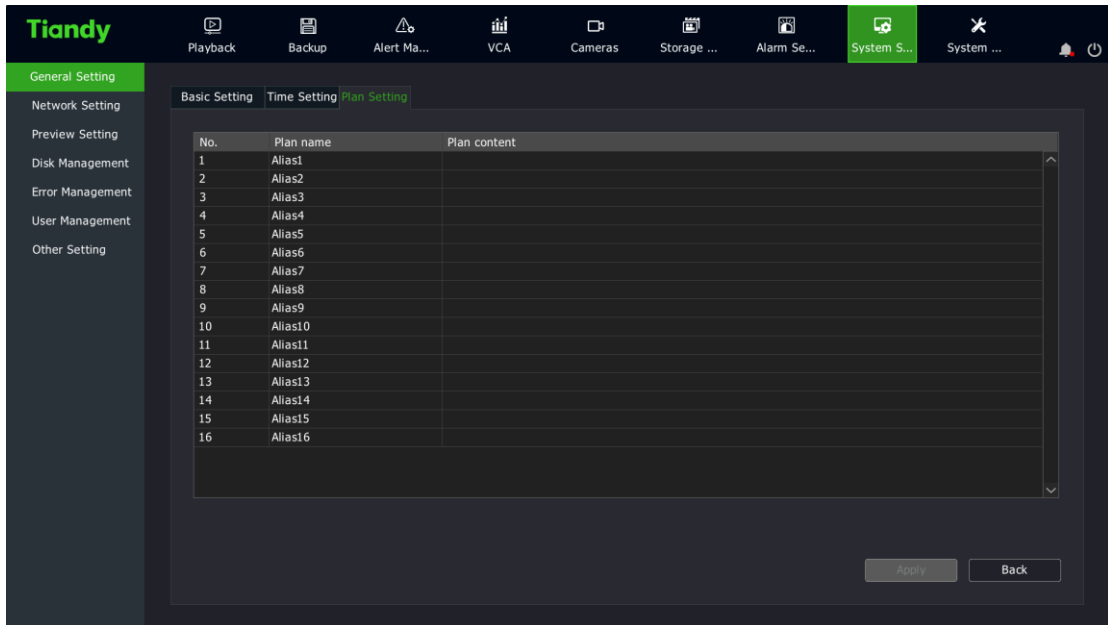

## 4.11.2 Network Setting

### Network Card

1. Select "Main Menu -> System Setting -> Network Setting -> Network Card" to enter the network card setting interface.

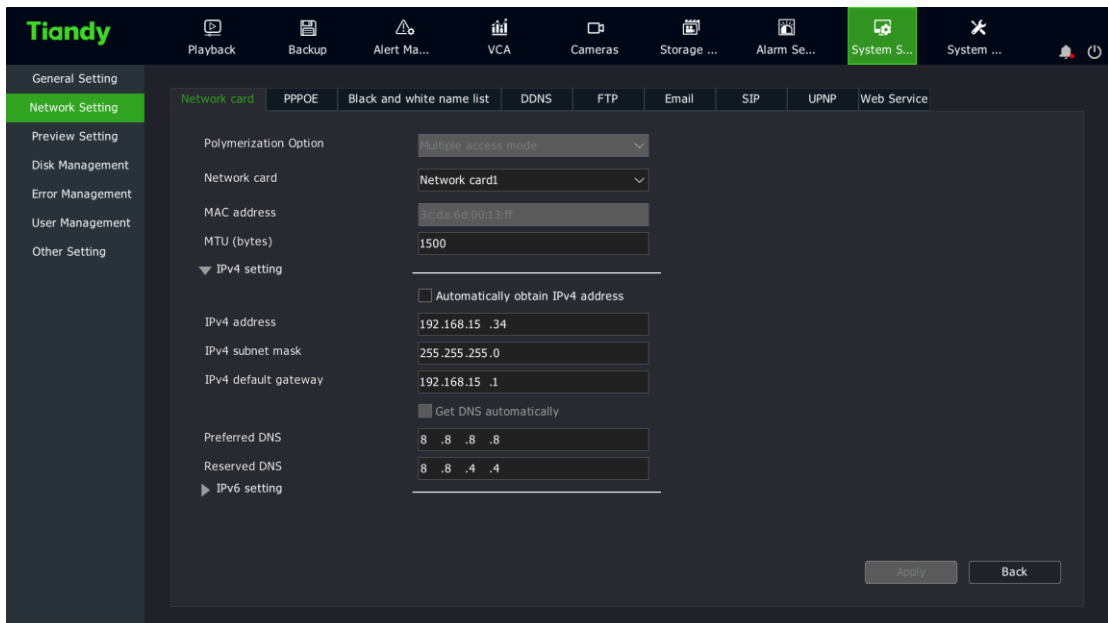

2. Choose to automatically obtain or manually set the IP address. If auto obtain is selected, the system will automatically obtain the IP address from the DHCP in the network.

3. When selecting "Automatically obtain IPv4 address", information including device's IP address, subnet mask, and gateway should be specified.

4. Aggregated options. There are three modes in the drop-down box: multiple access, load balance and redundancy:

- Network multiple access: In this mode, Network Card 1 and Network Card 2 work independently.
- Load balance: In this mode, the network load is evenly shared by two network cards.
- Network redundancy: In this mode, one network card works and the other is in standby mode. Once the working network card fails, the standby one will be immediately started to complete the seamless connection of network switching.

5. If multiple access mode is enabled, the configuration method of network card 2 is the same as that of network card 1.

6. Click the "Apply" button to make the settings effective.



### **Notes:**

- This interface is displayed only for devices with dual network cards, and aggregated options are unavailable for devices without dual network cards.
- Once the aggregation mode is set, the network parameters of network card 2 will be automatically filled in, with no need of user intervention.

### **PSE Network Card**



### **Note:**

- PSE series NVR models support PSE network card settings. This setting is unavailable for other models.

1. Select "Main Menu -> System Setting -> Network Setting -> Network Card" to enter the network card setting interface and select the PSE network card.

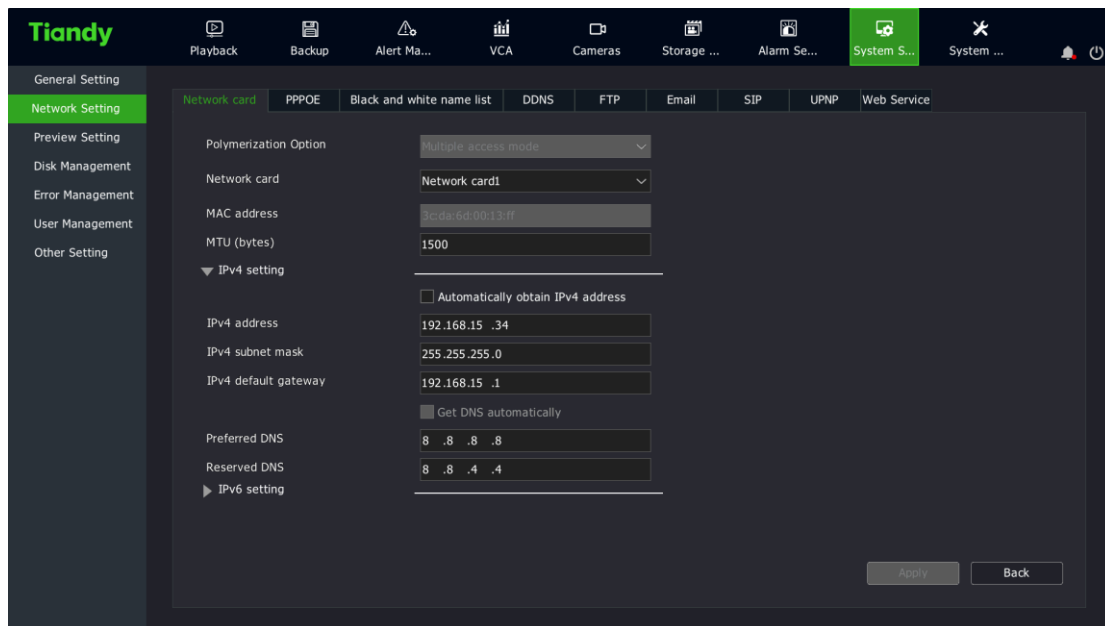

2. After setting the network address, the network address of the plug&play camera will be automatically set to the address of the network segment.



### Note:

- This interface will not be displayed for non-PSE devices.

## PPPOE

1. Select "Main Menu -> System Setting -> Network Setting -> PPPOE" to enter the PPPOE setting interface.

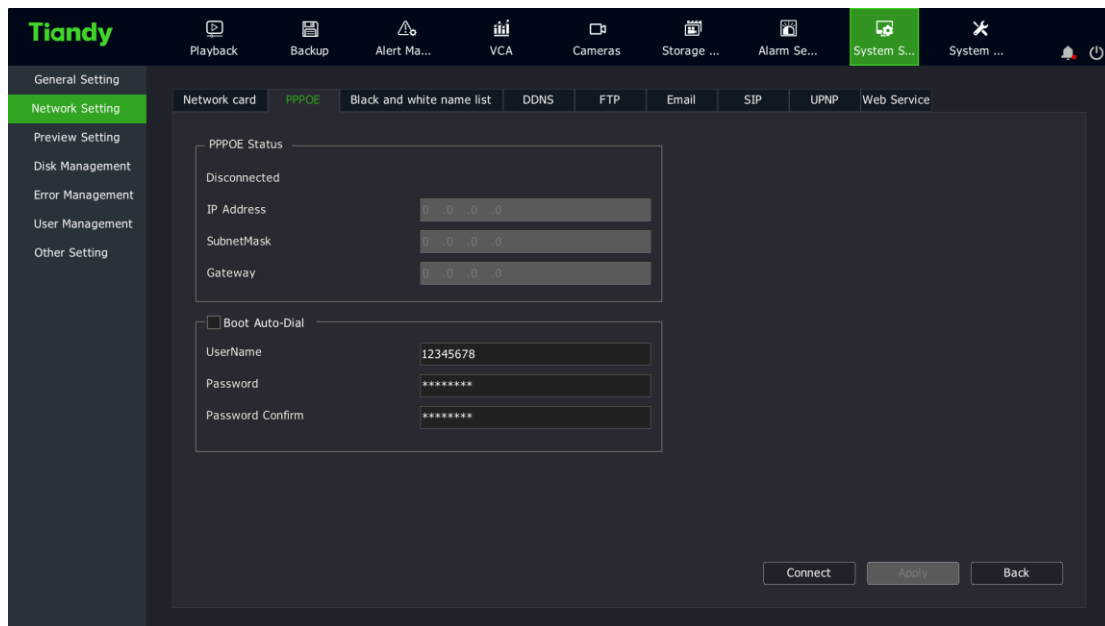

2. Set whether to dial automatically on startup.
  3. Enter the account and password of PPPOE dial.
  4. Click the "Connect" button to immediately start the PPPOE dial operation.
  5. Click "Apply" button to save the setting of PPPOE dial into the system.
- If the "Auto Dial on Startup" is selected, the system will automatically dial in the next startup.



#### Notes:

- This interface is not displayed for devices not supporting PPPOE.
- If you cannot dial properly due to network interruption or change of the modem, please manually click the "Disconnect" button and then try again.



## Black and White Name List

1. Select "Main Menu -> System Setting -> Network Setting -> Black and White Name List" to enter the black and white list setting interface.

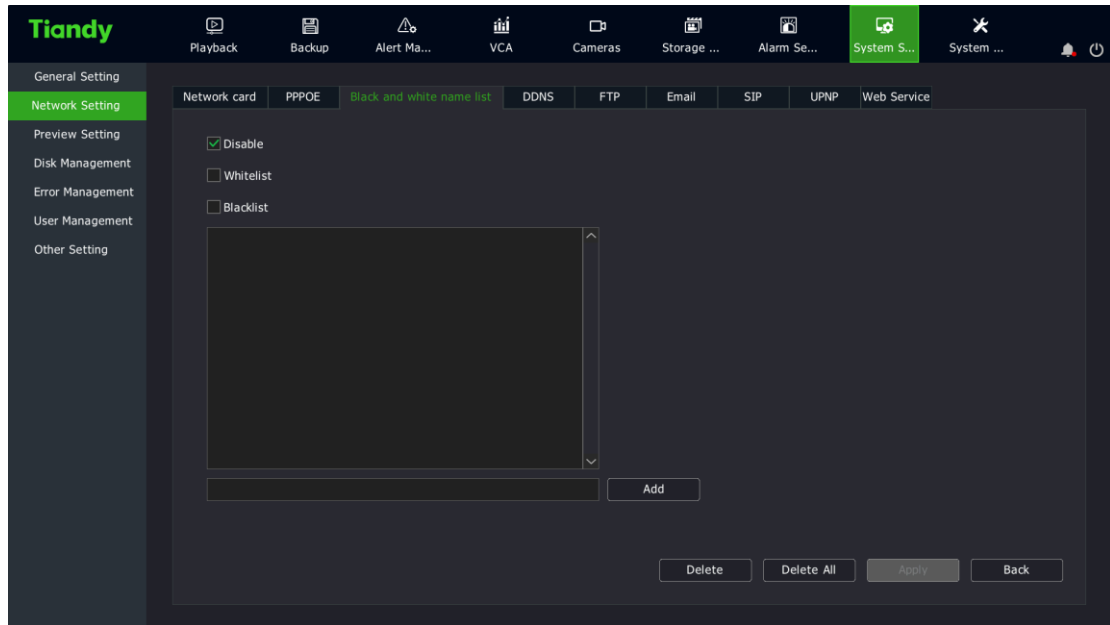

2. Choose the way how IP right is used: "Disable", "Whitelist" or "Blacklist".

3. Enter the IP address that needs to be disabled or enabled in the IP address input box.

4. Click the "Add" button to add the IP address to the list.

5. Click "Apply" to save the configurations.

## DDNS

1、 Select "Main Menu -> System Setting -> Network Setting -> DDNS" to enter the DDNS setting interface.

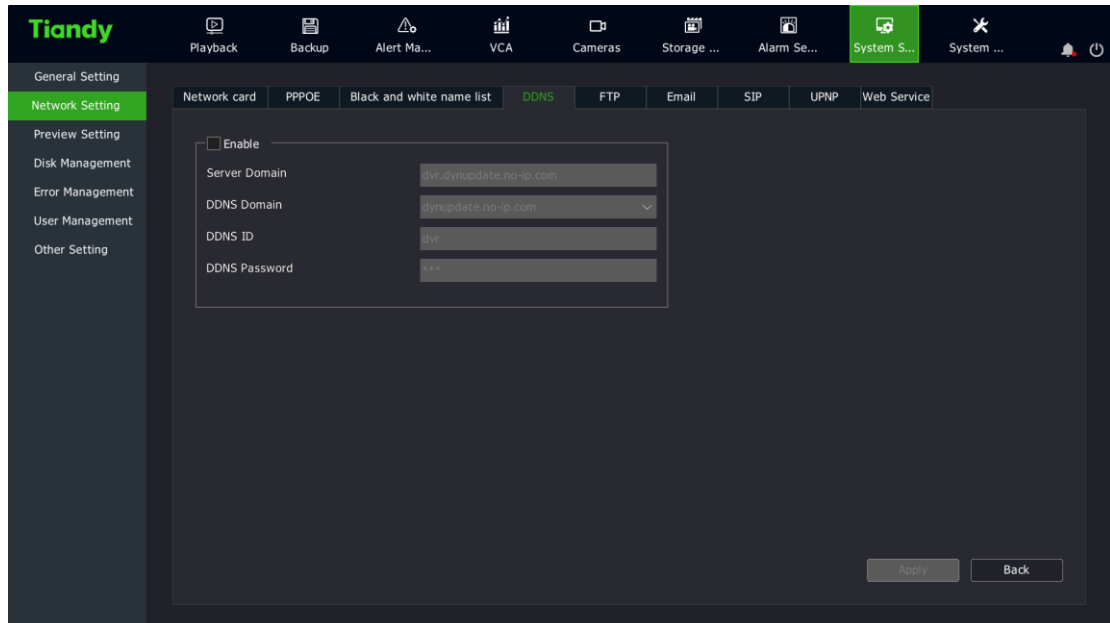

2. Set whether to enable the DDNS service.
3. Enter the device domain name.
4. Enter the domain name or IP address of the DDNS server.
5. Enter the login account and password of the DDNS server.
6. Click "Apply" button to save the configurations.

## **FTP**

1. Select "Main Menu -> System Setting -> Network Setting -> FTP" to enter the FTP setting interface.

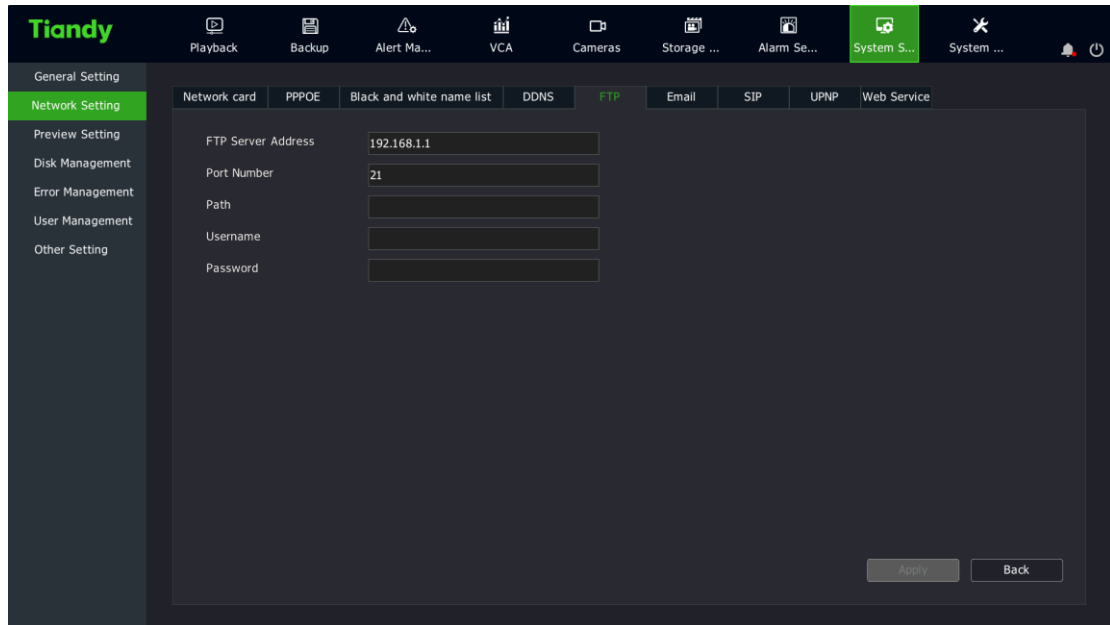

2. Enter the server address, port number, account and password of the FTP server.

3. Click "Apply" button to save the configurations.

## Email

1. Select "Main Menu -> System Setting -> Network Settings -> Email" to enter the Email setting interface.

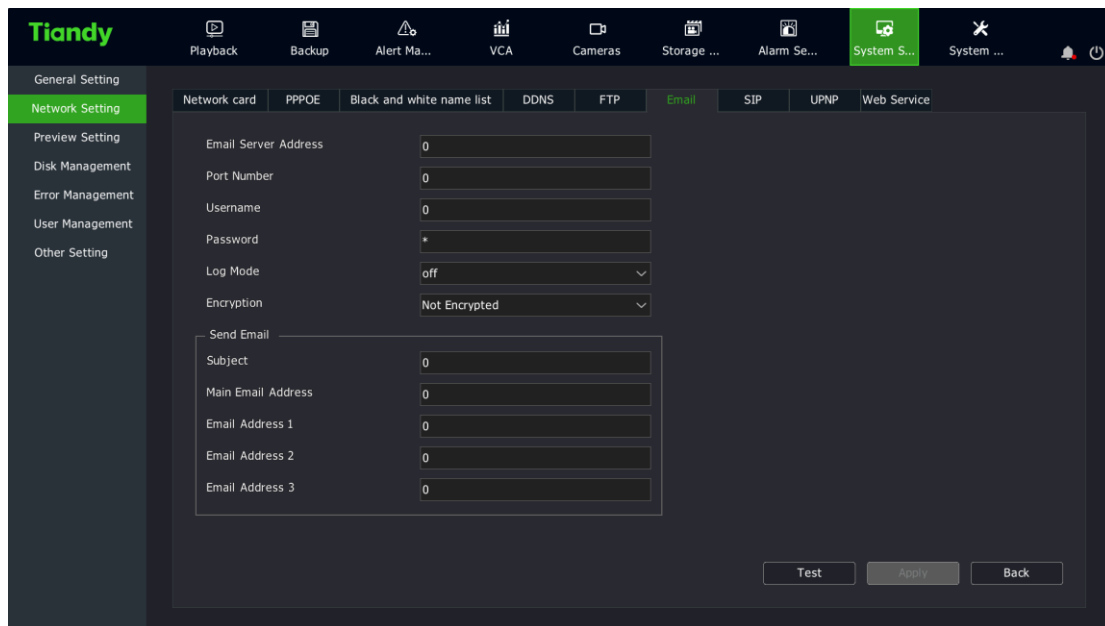

2. Enter the server address, port number, account, password, encryption mode, recipient address and subject of the Email server.

3. Click "Apply" button to save the set parameters.

## SIP

1、 Select "Main Menu -> System Setting -> Network Setting -> SIP" to enter the SIP interface.

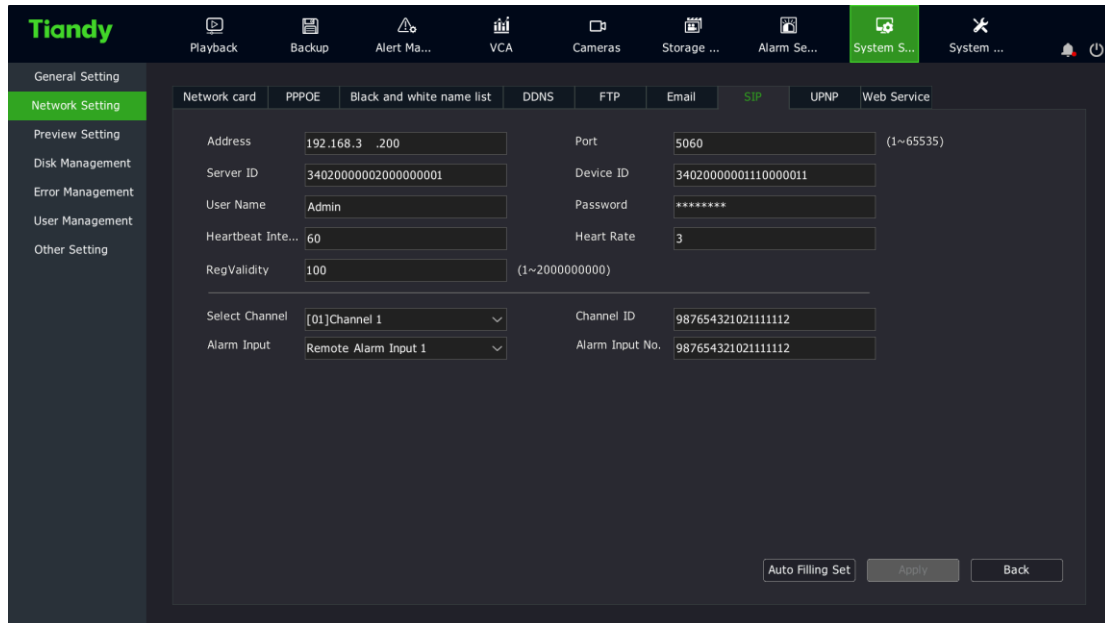

2. Enter address, server ID, account, heartbeat interval, term of validity, port, device ID, password, heartbeat rate, channel selection, channel number, alarm input and alarm input number.

3. Click "Apply" button to save the set parameters.

4. Click the "Auto Fill" button, and the channel number and alarm input number of the current channel will be incremented by one in turn.

## UPNP

4. Select "Main Menu -> System Setting -> Network Setting -> UPNP" to enter the UPNP interface.

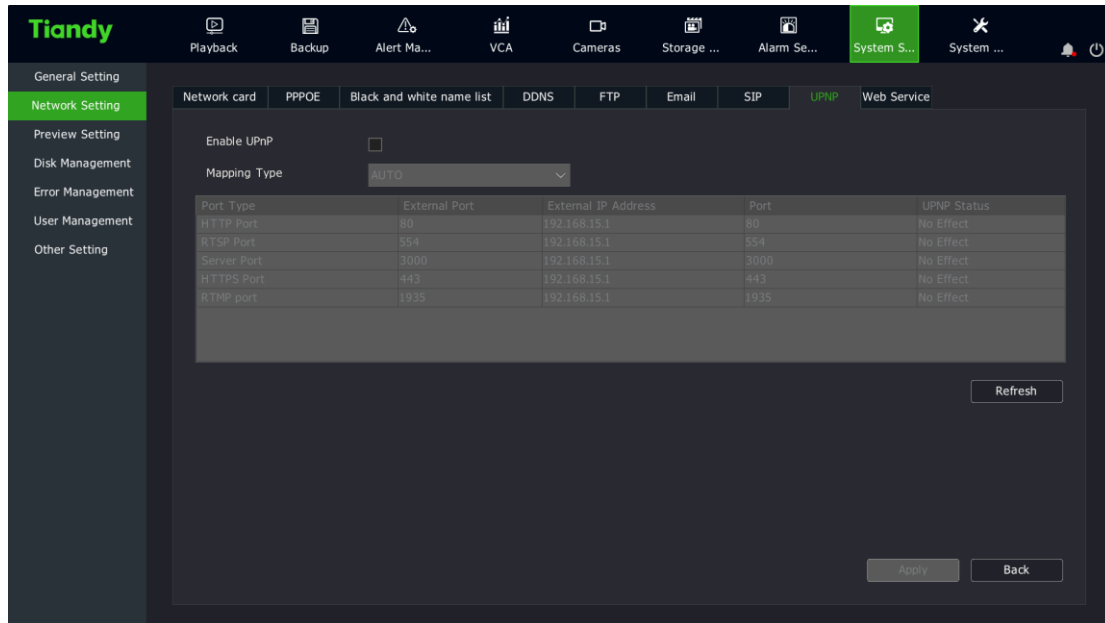

2. Check the "Enable" option to enable "Mapping Type" check box.
3. When "Mapping Type" is selected as "Auto" , the default external port is used for corresponding services; when "Manual" is selected, the external port can be edited and then used for corresponding services. HTTP port and RTSP external port support 1-65535, and external ports for service ports support 1-65534.
4. Click the "Save" button to save the settings.

## Network Services

1. Select "Main Menu -> System Setting -> Network Setting -> Network Service" to enter the network service interface.

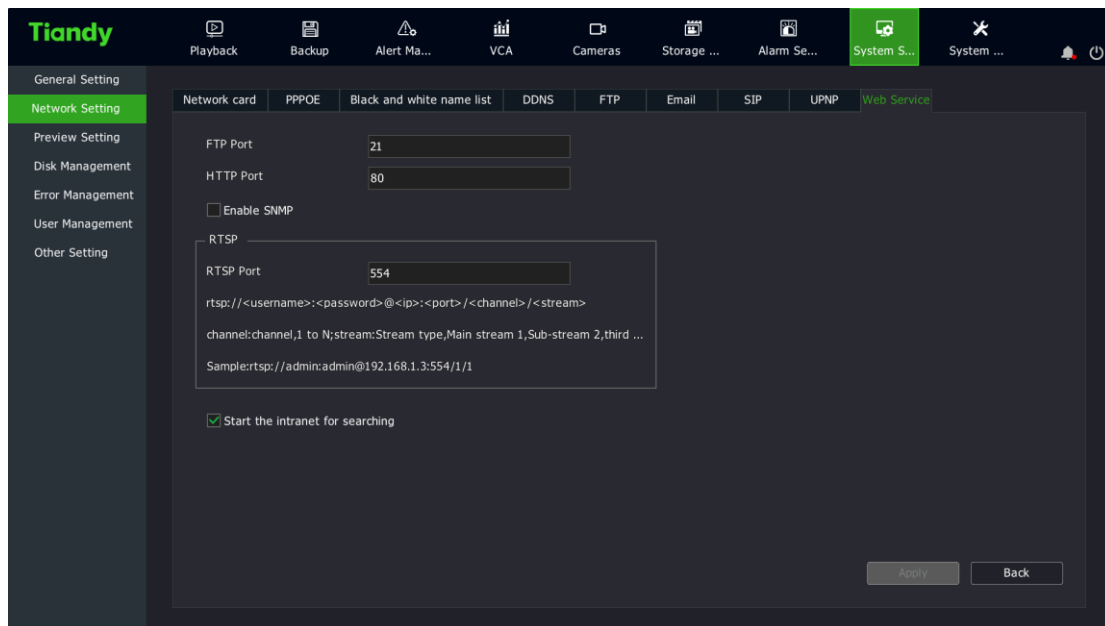

(1) The FTP and HTTP ports of the device can be modified on this interface, where you can also set whether SNMP service is enabled or not.

(2) Check the “Enable Intranet search” option to search devices in different segments under the same route.

### 4.11.3 Disk Management

#### Basic Configuration

1. Select "Main Menu -> System Setting -> Disk Management -> Basic Configuration" to enter the basic setting interface. When the device is connected to two or more disks and configured as the same disk pack, the edit column in the list displays . Click to modify the purpose of the disk, including read-write, backup, redundancy, and read-only.

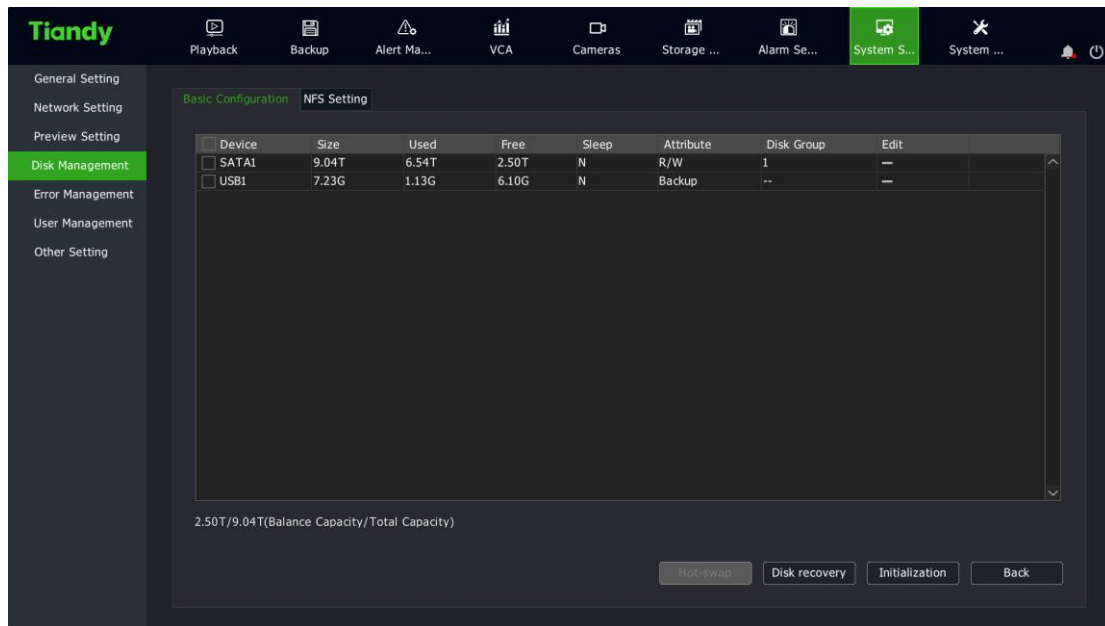

2. The interface can display the total remaining capacity and total capacity of the current HDD and virtual disk.

3. Hot-swap. Select a disk from the disk list and click the "Hot-swap" button. The system will display "Hot-swap will lead to the offline of the disk, which can only be online by restarting the device or plugging the disk."

 **Note:**

- The hot plug button is disabled for devices that do not support hot plug function.

4. HDD detection. Sets whether all disks are detected when the device is powered off and restarted, and whether corrupted disks are fixed. Click



the "Disk Detection" button to display the disk detection form, as shown in the figure below.

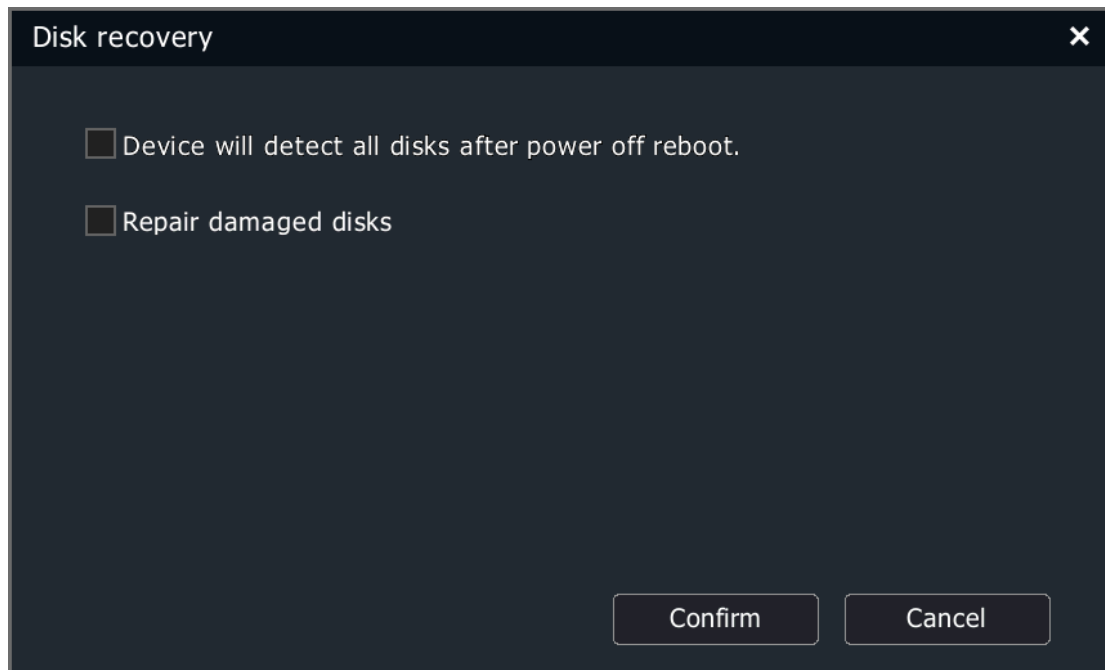

5. Initialization: Initializes the selected disk, and an initialization format can be selected for the USB flash drive.

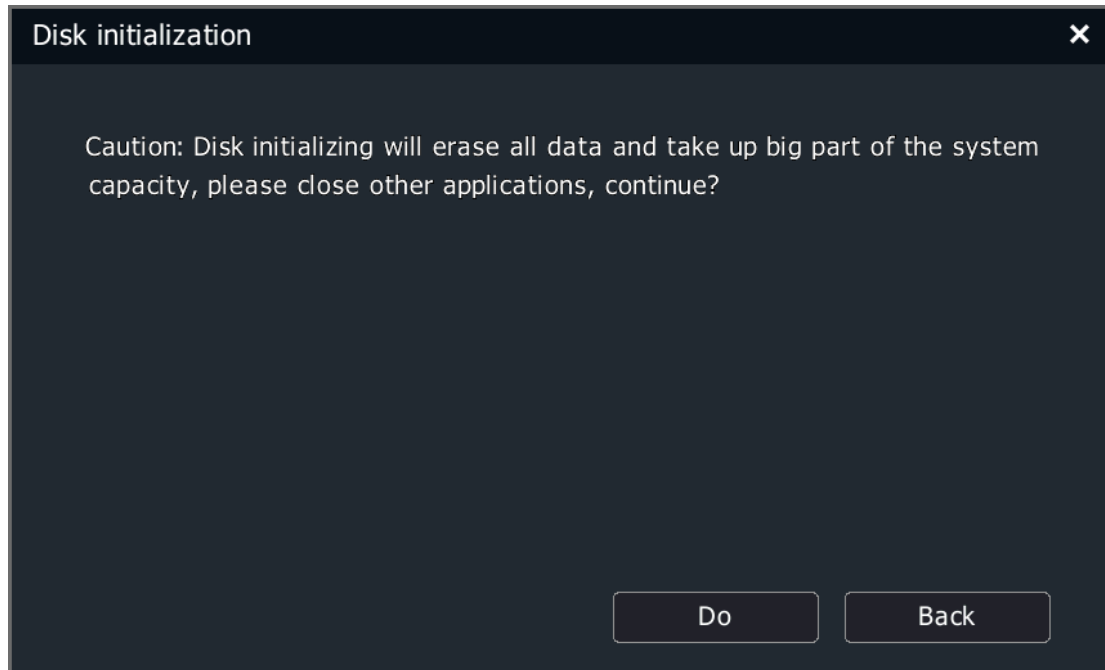

 **Note:**

- The file system is not displayed for devices that does not support the initialization format selection for the USB flash drive.

### **NFS Setting**

1. Select "Main Menu -> System Setting -> Disk Management -> NFS Setting" to enter the NFS setting interface.

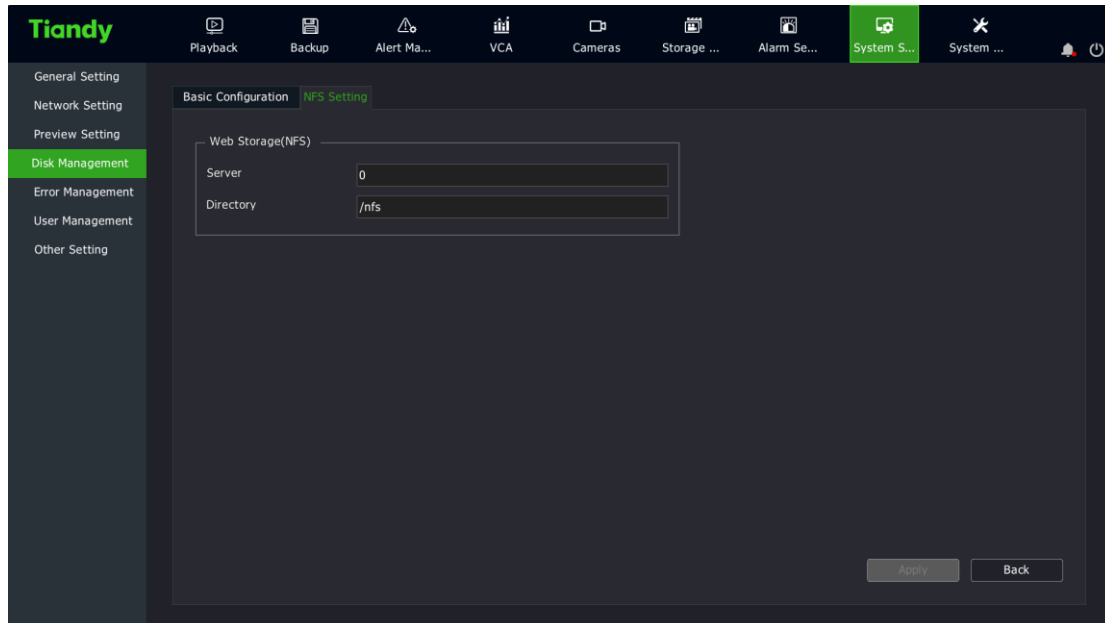

2. Set the IP address (domain name) and directory of the "NFS" service.

3. Click "Apply" to save the configurations.

#### 4.11.4 Array Management

TC-NR2020M7-E8, TC-NR2040M7-E8, TC-NR2080M7-E8, TC-NR2080M7-E16, TC-NR2160M7-E16, TC-NR2020M7-S, TC-NR2040M7-S8 and TC-NR2080M7-S8 support disk array. Disk array shall be set before being used.

#### Physical Disk

1. Select "Main Menu -> System Settings -> Array Management -> Physical Disk" to enter the physical disk interface, where the basic information of all physical disks of the current device is displayed, including capacity, related array, disk type, disk status and disk model.

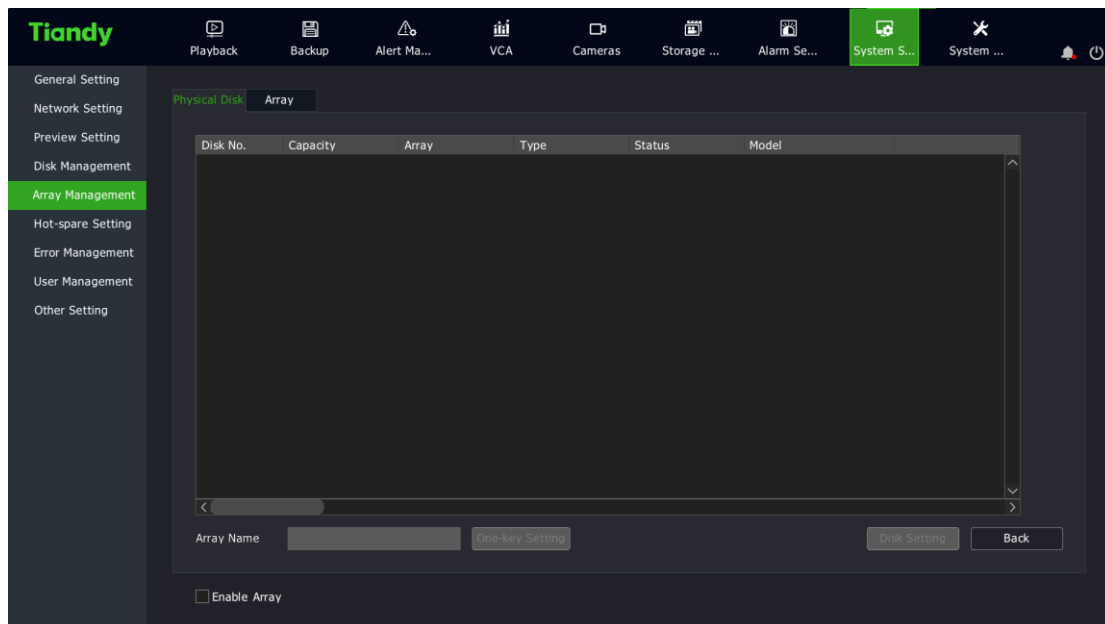

2. Enable array. Check "Enable Array" and the operation will take effect after reboot.

3. One-key config. After entering "Array Name", click the One-key Config button, and the device will automatically create an array.

4. Disk setting. After selecting a disk, click the "Disk Setting" button to set the disk as "Idle Disk", "Array Hot Standby Disk" or "Global Hot Standby Disk".

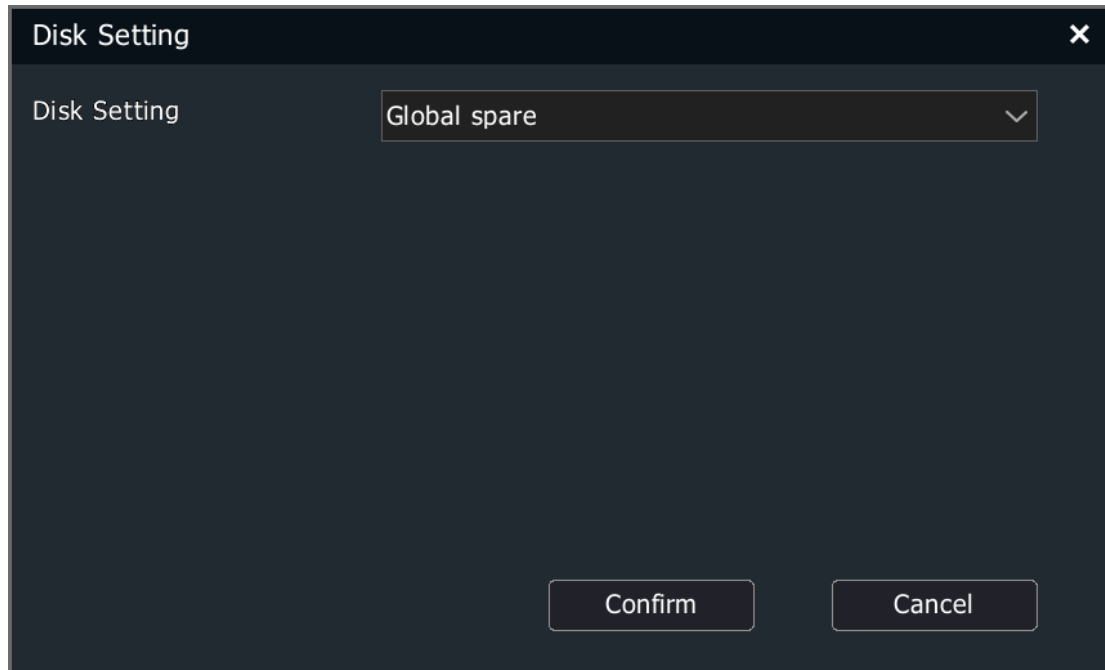

### Notes:

- Rules for creating arrays with One-key Config: The system first creates a global hot standby disk and then creates up to 3 RAID5 arrays based on the number of remaining disks. At least three hard disks are required to create a RAID5 array and up to 8 disks are supported; If there are less than 3 disks left, set the remaining disks as idle disks.
- The device supports only one global hot standby disk.

### Array

1. Select "Main Menu -> System Settings -> Array Management -> Array" to enter the array interface.

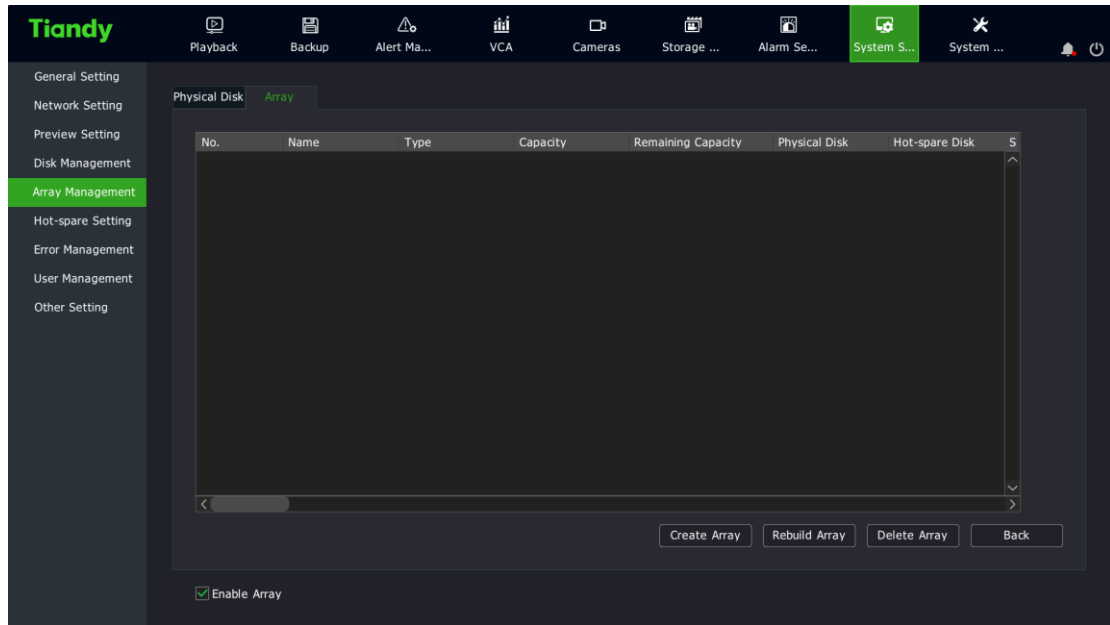

2. Create an array. Click the "Create Array" button to enter the Create Array interface, as shown in the figure below. To create an array, you must specify a array name, array type, physical disk that makes up the array, and the hot standby disk number. When all the information is set, click the OK button to start creating the array.

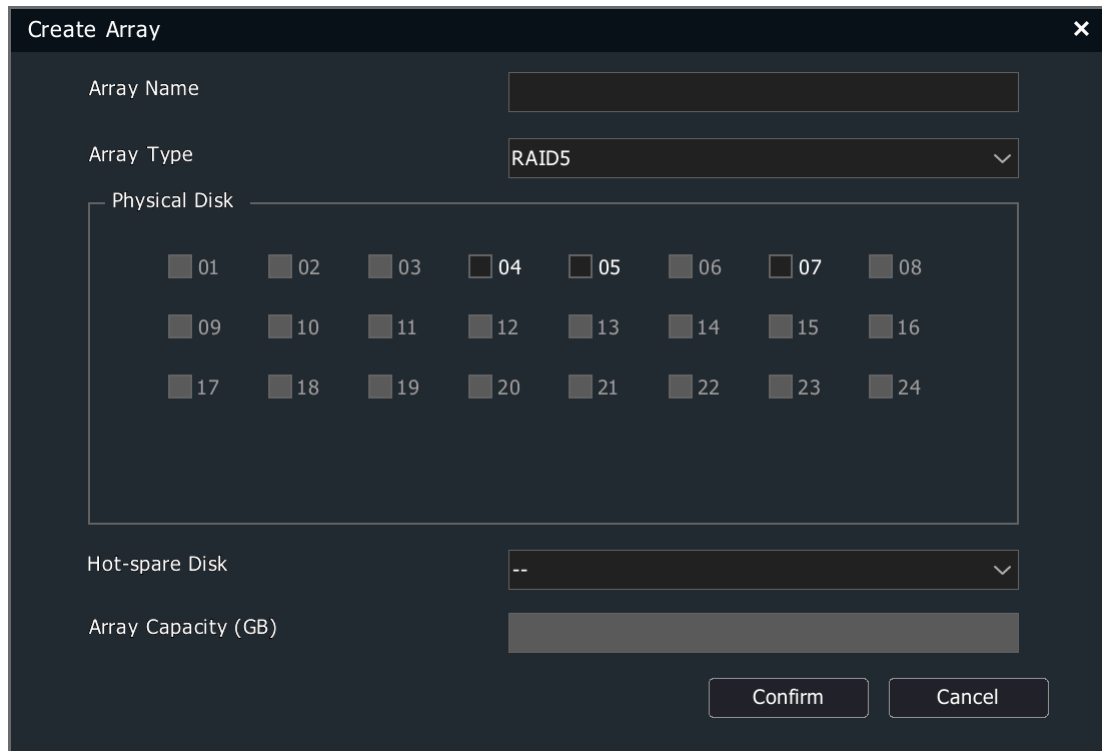

The image shows a 'Create Array' dialog box with a dark theme. It contains the following fields and controls:

- Array Name:** A text input field.
- Array Type:** A dropdown menu currently set to 'RAID5'.
- Physical Disk:** A grid of 24 square buttons labeled 01 through 24. Buttons 01-03, 06, 09-16, 19-24 are filled with a dark gray color. Buttons 04, 05, and 07 are empty.
- Hot-spare Disk:** A dropdown menu currently set to '--'.
- Array Capacity (GB):** A text input field.
- Buttons:** 'Confirm' and 'Cancel' buttons at the bottom right.

 **Notes:**

- Array hot backup disks are not supported for JBOD and Raid0.
- Each array supports only one array hot standby disk.

3. Rebuild array. When an array is "Degraded", the array can be rebuilt. Select the disk number to be substituted into the array and click the OK button to begin rebuilding.

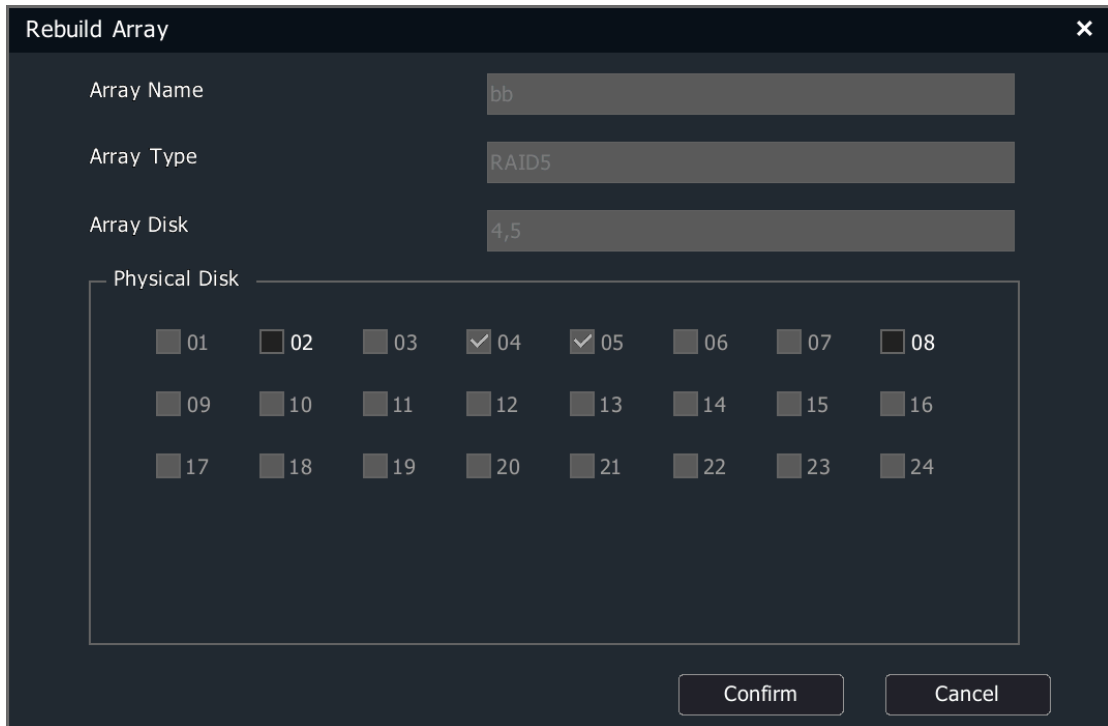

5、 Delete array. Select the array to delete from the array list and click the "Delete" button to delete the selected array from the system.

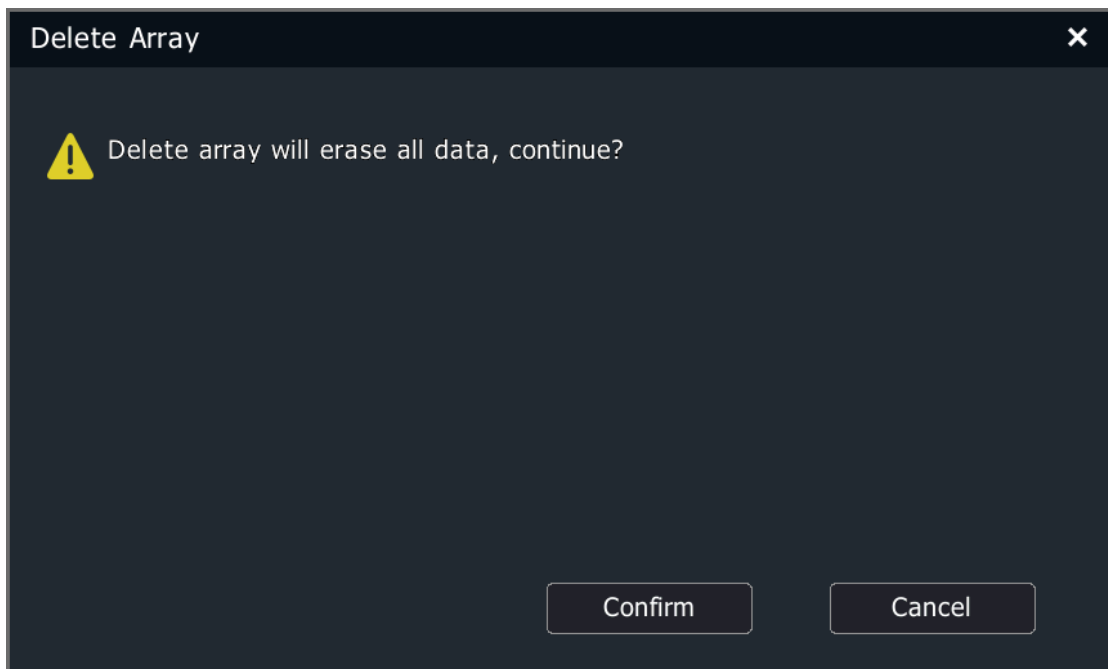



#### 4.11.5 Hot-spare Setting

Enable the hot standby system (Note: The hot standby function is unavailable for 4- and 8-channel NVR and PSE series NVR). When a device in the hot standby system fails, the system will automatically switch to the hot standby unit which will work to ensure the continuity of video recording.

A hot standby system consists of several active units and hot standby units. An active unit can be set with up to 16 hot standby units. When the hot standby unit detects that the active unit is disconnected, the hot standby unit will actively connect to the front IPC connected to the active unit and start recording. When the hot standby unit detects that the active unit is connected, it will actively disconnect from the front IPC and upload the previous backup video to the active unit.

#### **Active Unit Setting**

1. Select "System Settings -> Hot-spare Setting" from the Main Menu to enter the hot standby setting interface.

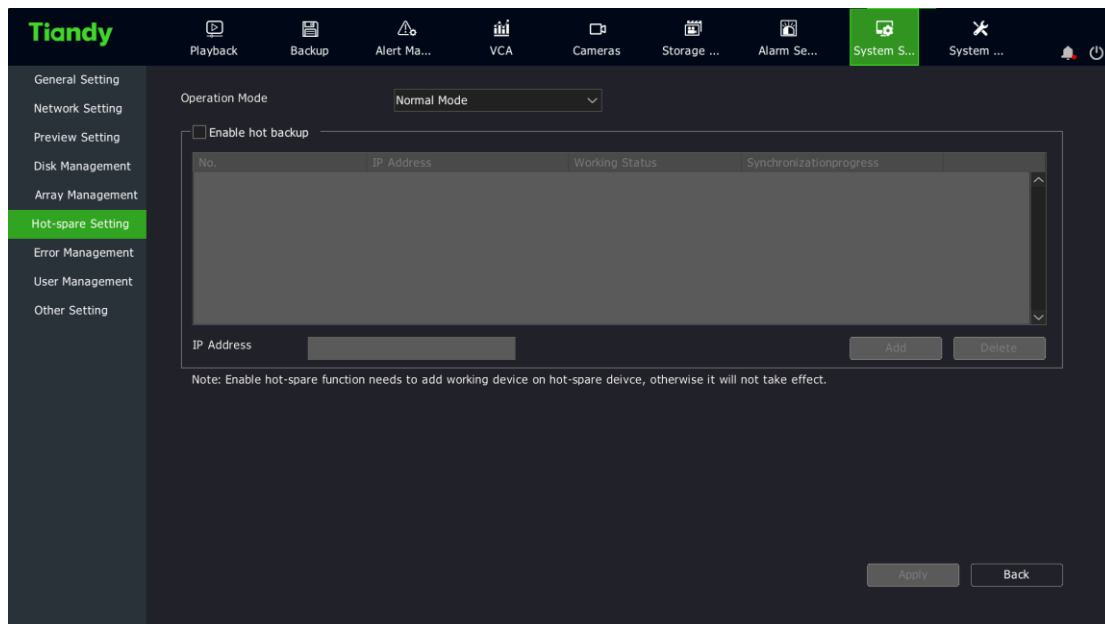

2. Select the Normal working mode.
3. Check Enable Hot Standby, set the IP address of the hot standby unit, and click "Add"; or select the IP to delete and click "Delete".
4. After the specified hot standby unit is set and connected to the system successfully, the working status will be updated to "Connected Successfully"; When the hot standby unit actively uploads the backup video files, the working status is shown as "Sync Now", and the synchronization progress bar shows the synchronization percentage.

### Hot Standby Unit Setting

1. Select "System Settings -> Hot-spare Setting " from the Main Menu to enter the hot standby setting interface.
2. Select the Hot Standby mode.

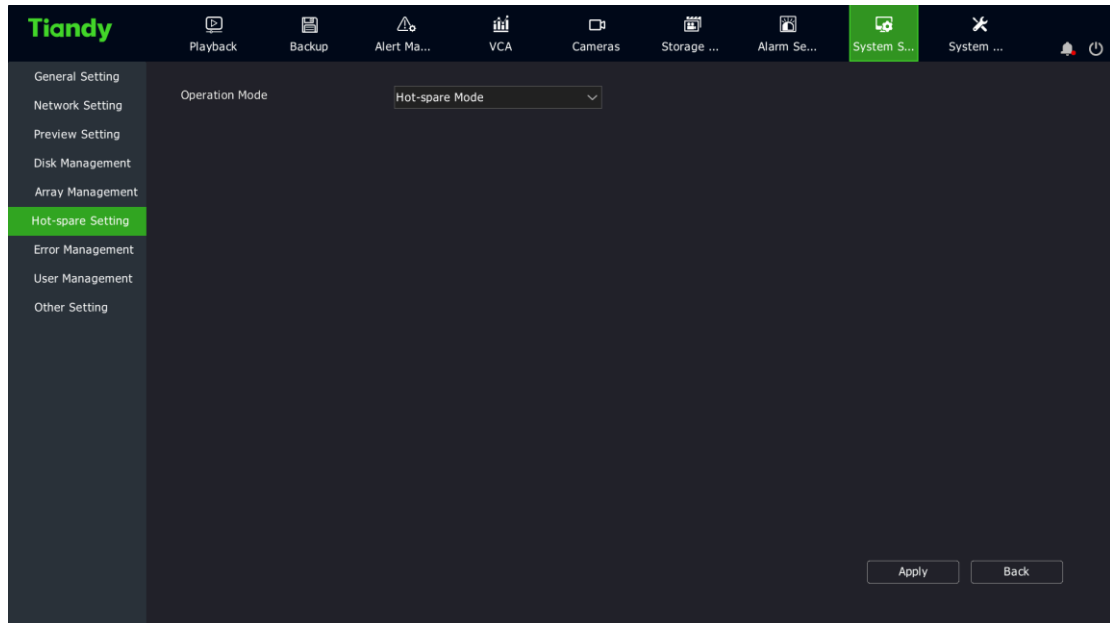

3. Click the "Apply" button, and the system prompts that the device needs to be restarted to make the setting effective.

4. When the device restarts and enters the hot standby working mode, the main interface of the system will change accordingly, and only hot standby setting, video setting, system setting, user management and shutdown options are available.

5. Select "System Setting -> Hot-spare Setting " from the Main Menu to enter the hot standby setting interface.

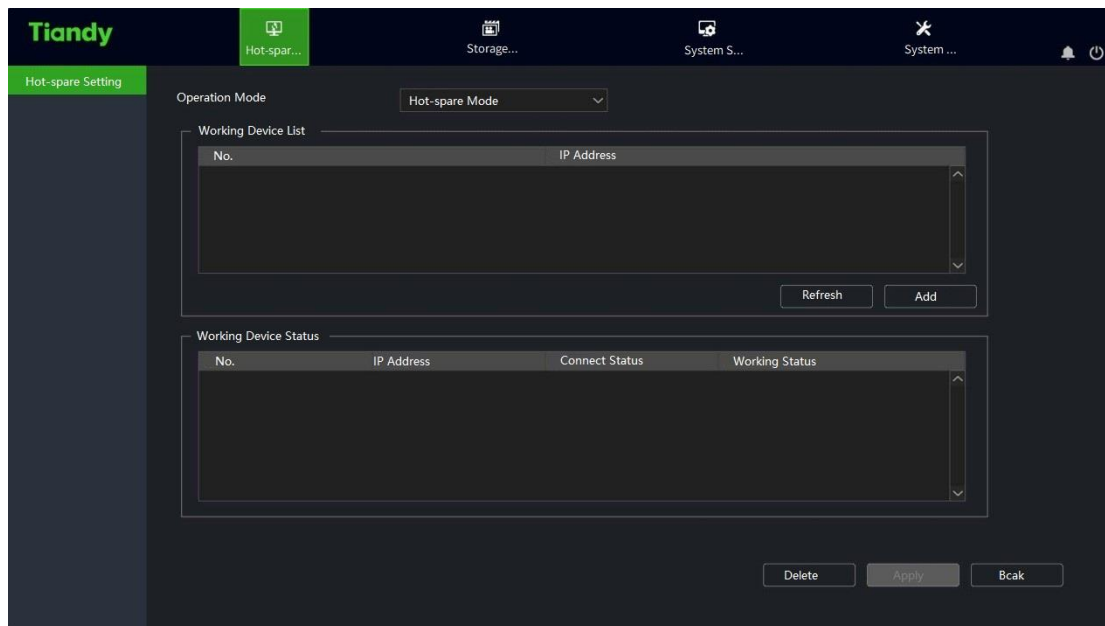

6. Click the "Refresh" button to display active units with hot standby function enabled in the active unit list. Select the active unit to set hot standby mode.

7. Click the "Add" button, and the system will prompt you to enter the login username and password of this active unit. After verification, the IP and connection status of the active unit will be displayed in the active unit status list. If the password is wrong, the active unit status list will also show the IP of the active unit, but the status of the hot standby unit will be shown as "Connection failed" .

8. Click "Apply" to save the configurations.

9. On the hot standby configuration interface of the hot standby unit, select "Normal mode" to switch the hot standby unit back to the active unit.



## Notes:

- After the hot standby unit is changed to the active unit, the defaults should be restored manually.
- The system time of the active unit shall be the same as that of the hot standby unit.

### 4.11.6 Error Management

#### Network error

1. Select "Main Menu -> System Setting -> Error Management -> Network error" to enter the network exception setting interface, as shown in the figure below.

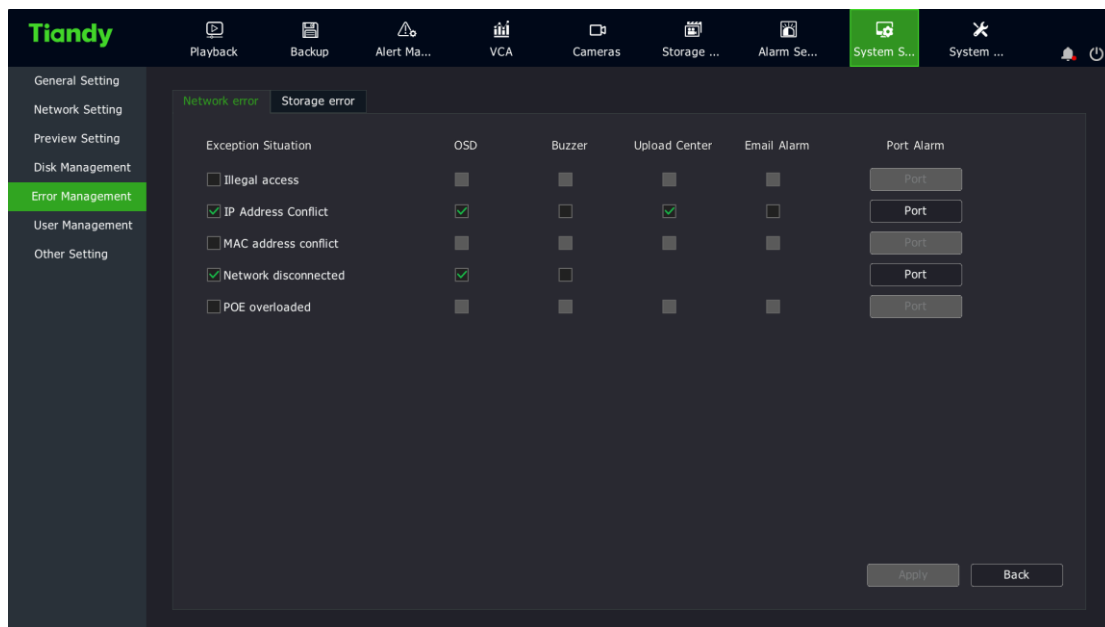

2. If exceptions are checked, the corresponding linkage actions of the system, including screen display, voice prompt and upload center, can be checked when these exceptions occur.

## Storage error

1. Select "Main Menu -> System Setting -> Error Management -> Storage error" to enter the storage exception setting interface, as shown in the figure below.

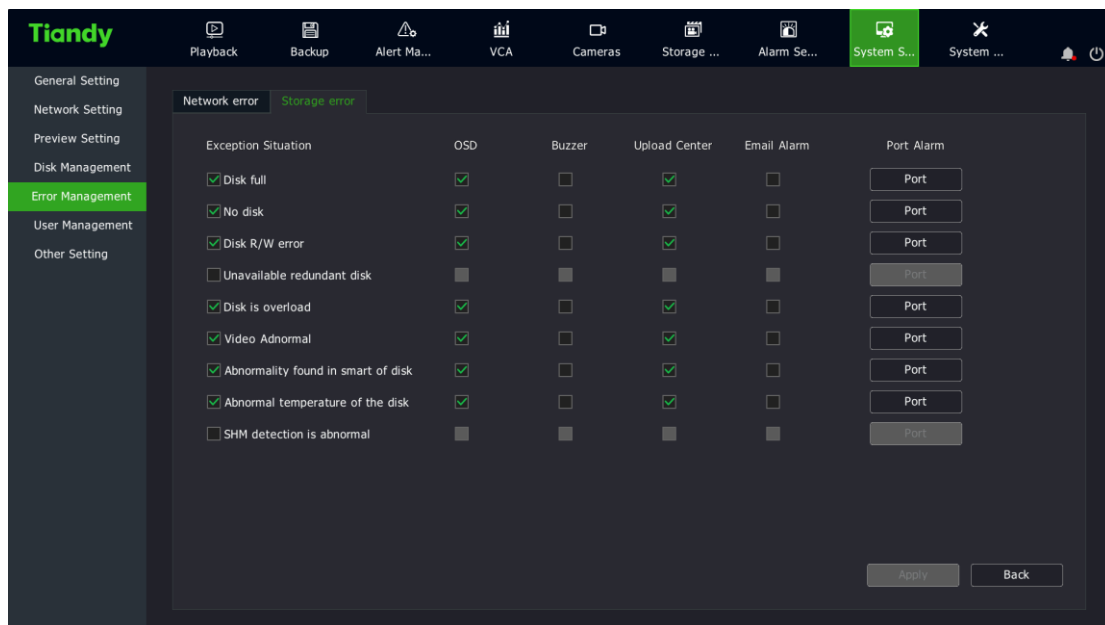

1、 If exceptions are checked, the corresponding linkage actions of the system, including screen display, voice prompt and upload center, can be checked when these exceptions occur.

## 4.11.7 User Management

### Add User

1. Select "Main Menu -> System Setting -> User Management" to enter the user management interface, as shown in the figure below:

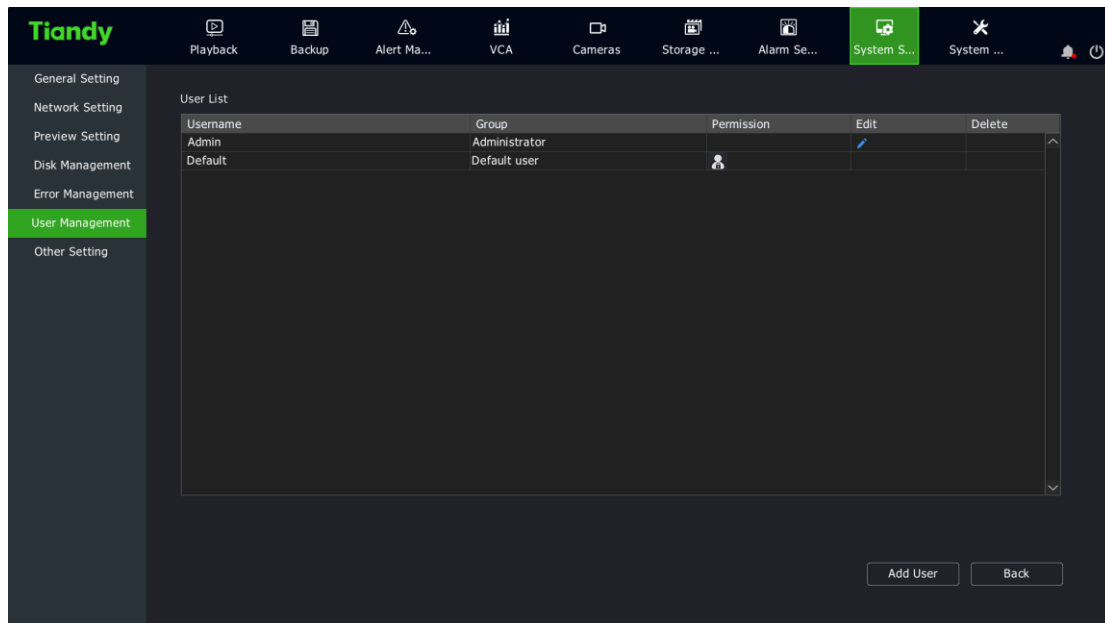

 **Note:**

- The Default user is added. The Default user is active after logoff. Only local preview right can be configured for this user.

2. Click "Add User" to enter the "Add User" interface, where you can set the user group, account, password, etc., as shown in the figure below:

Add User

Add to Group: Guest

Username: [input field]

Password: [input field] [strength indicator]

*i* Please generate 8-15 digits password with two or more combinations of numbers, lowercase, capi...

Password Confirm: [input field]

Confirm Cancel

### Notes:

- After a user is successfully added, the information about the added user is displayed in the Basic Config -> User List.
- Up to 16 users can be added.
- There are three user groups in the system: "Default users" , "Normal users" , and "Administrator" . The default permissions for each user group are as follows:

Default users: browse videos

Normal users: browse videos

Administrator: browse videos + device control + parameter setting  
+ user management



## User Permission Management

1. Click the  in the user list to display the user permission editing form, as shown in the figure below:

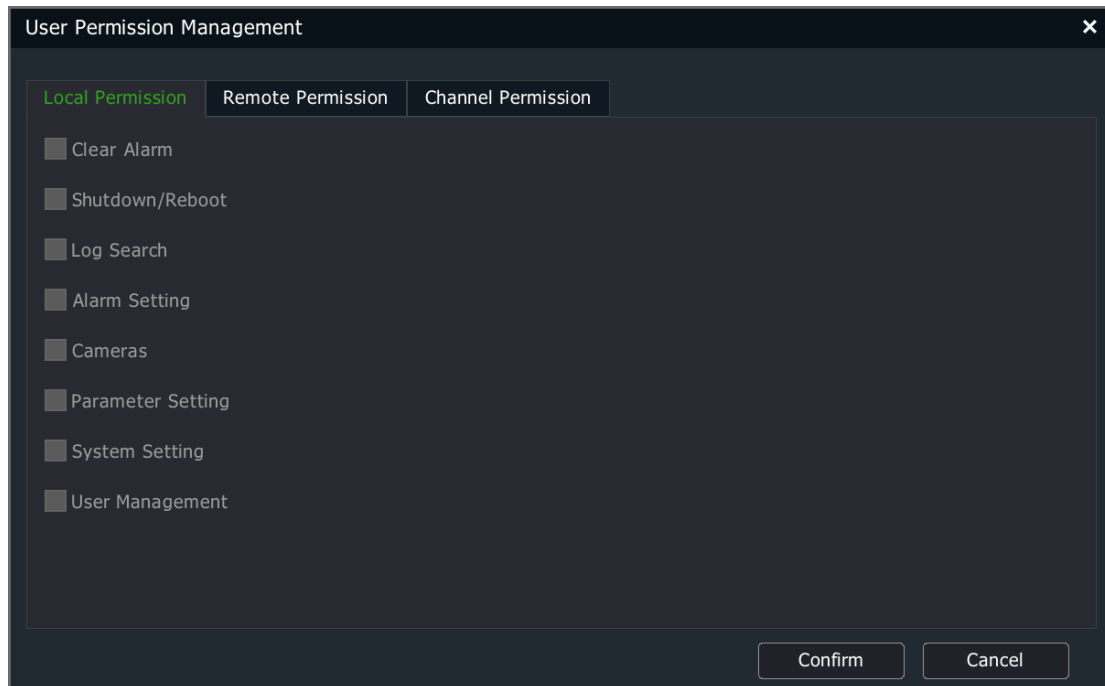

2. Descriptions of permissions:

(1) Local permissions: i.e. local operation permissions, including manual alarm clearing, shutdown/restart, log search, alarm setting, channel management, parameter setting, system setting and user management.

(2) Remote permissions: i.e. operation permission on a remote client, including manual alarm clearing, shutdown/restart, voice intercom, log search, alarm setting, channel management, parameter setting, system setting and user management.

(3) Channel permissions: Local preview, remote preview, local playback/snapshot browsing, remote playback/snapshot browsing, local PTZ control, and remote PTZ control.

### 3. Descriptions of channel permissions:

If the current user does not have the local preview permission for a channel, the channel will be unchecked (channel 4 as shown in the figure below). If the user has the local preview permission for the channel, the channel will be checked.

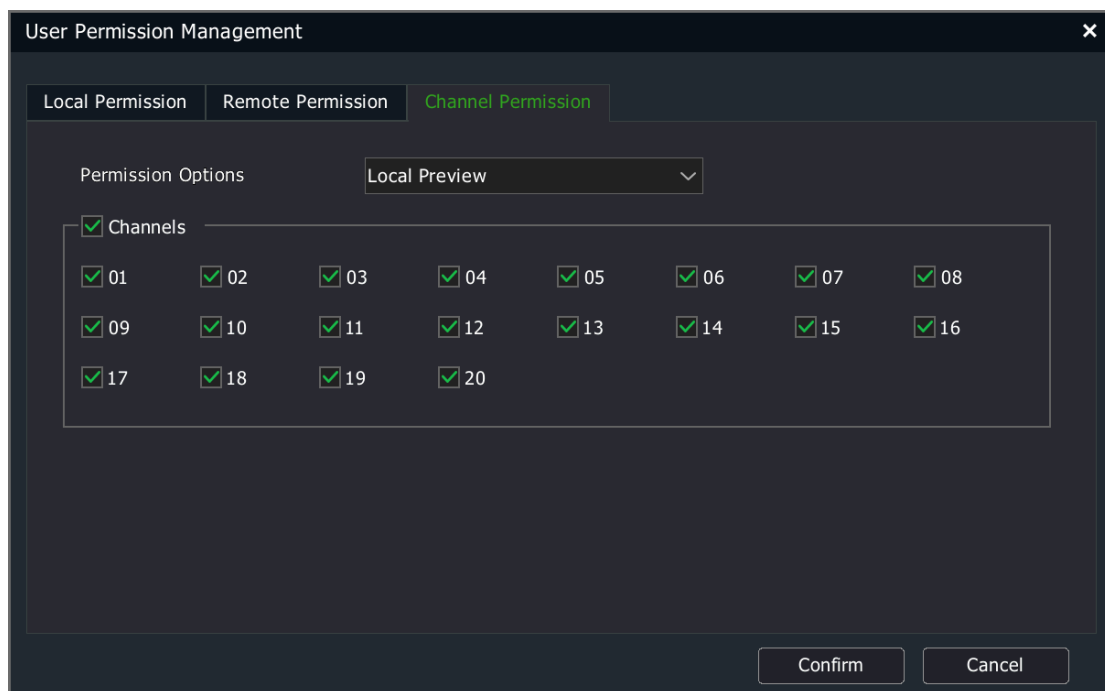

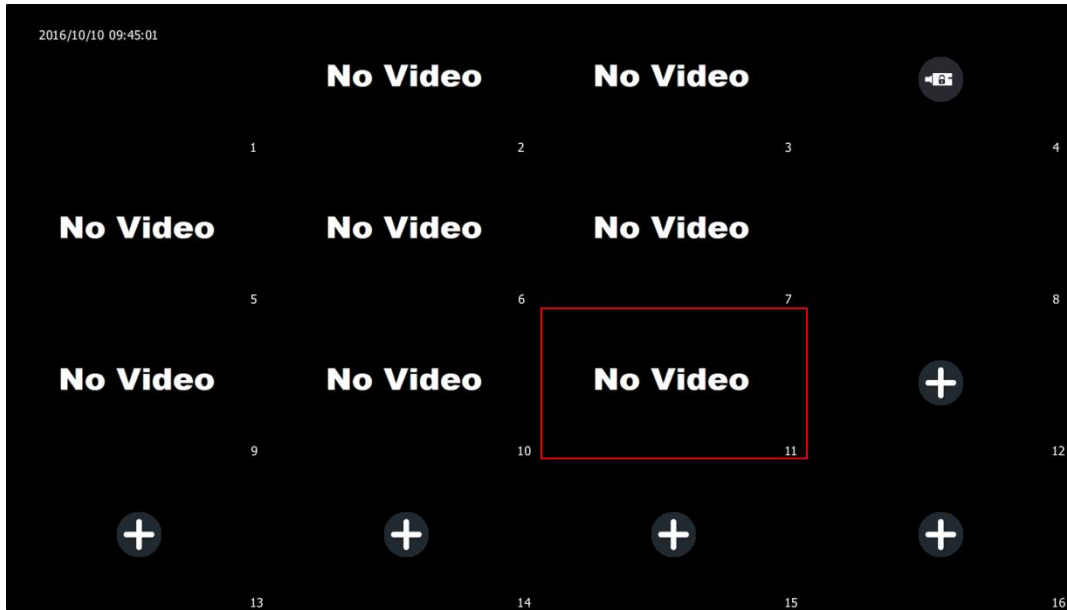

## Edit User

1. Click  in the user list to display the edit user form, as shown in the figure below:

**Edit User**

Username: Admin

Move to Group: Administrator

Previous code: [Redacted]

Change code

New Password: [Redacted] [Redacted] [Redacted]

 Please generate 8-15 digits password with two or more combinations of numbers, lowercase, capi...

Password Confirm: [Redacted]

Reserved Email: 1111@qq.com (For Password Reset)

Code protection question: Set code prot...

Start unlocking image: Image setting

Confirm Cancel

 **Note:**

- Pattern unlocking and security problems are only available for admin user; The original password shall be entered to edit the admin user and click "OK".

## 2. Pattern Unlocking

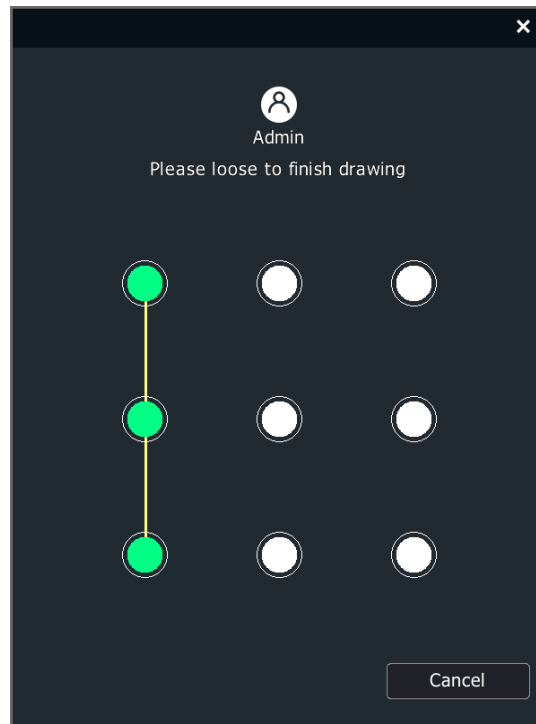

(1) After checking Enable Pattern Unlocking, the form as below will appear. The unlocking pattern can be correctly set only when a pattern composed of the same 4 points or more is drawn twice as instructed.

(2) Pattern unlocking is only available for the admin user.

(3) Pattern unlocking is not enabled by default on startup. After setting successfully, you can click pattern setting to modify the pattern.

### 3. Security Problems

(1) Set security problems: After the admin user logs in, edit the user, and click the "Set Security Problems" button to enter the security problems setting interface, as shown in the figure below.

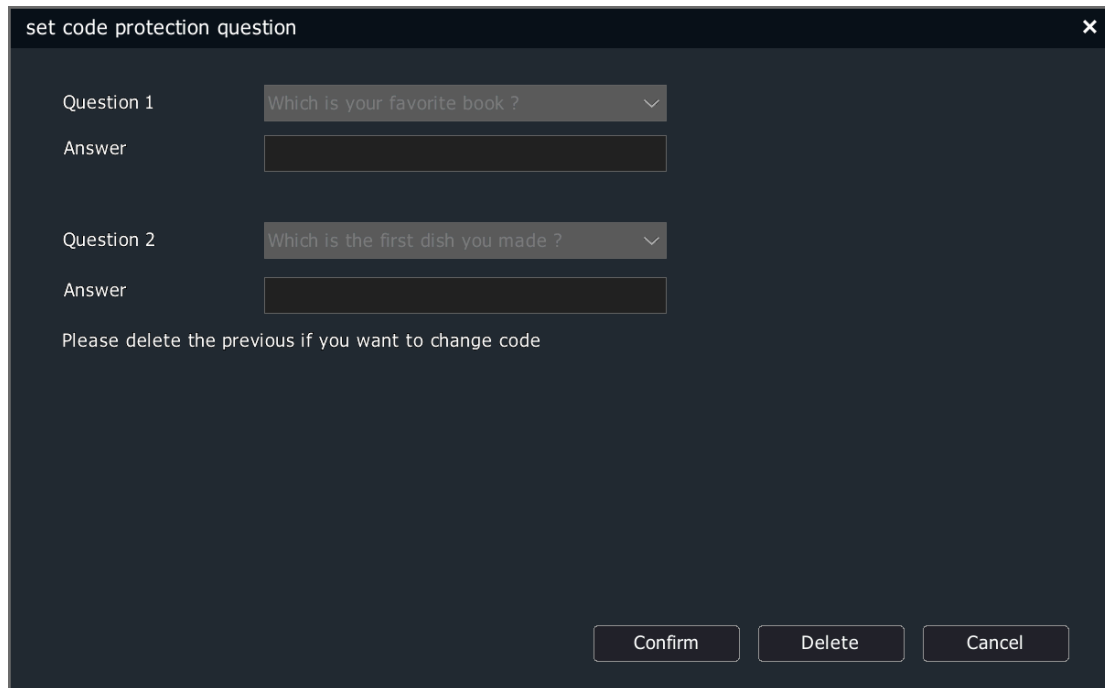

set code protection question

Question 1 Which is your favorite book ?

Answer

Question 2 Which is the first dish you made ?

Answer

Please delete the previous if you want to change code

Confirm Delete Cancel

Users can set 2 security problems. If custom problems are selected, the problems shall not be left empty.

(2) Security verification: In case that security verification is set, when the admin user logs in with his password, he can click the "Forget Password" button to change the password, as shown in the figure below:

Login

Username

Password

Save Password

Click the "Forget Password" button to enter the security verification interface, as shown in the figure below:

code protection verification

Reserved Email  Code protection question

---

Note(Only for admin user):



1. Please use the mobile APP to enter the password retrieval interface to scan the left QR code.
2. Operation done, security code will be sent to your mail.

Please input security code.

Email:

- 1) Download the mobile APP to enter the password retrieval interface. (For the mobile APP download website, see Section 4.15 Mobile Monitoring "Mobile APP" )
- 2) Scan the QR code on the left (the picture is for reference only).
- 3) After scanning the QR code, the Email you leave will receive the security code.
- 4) Enter the security code to reset the new password.

code protection verification

Reserved Email       Code protection question

---

Question 1      Which is your favorite book ?

Answer     

Question 2      Which is the first dish you made ?

Answer     

Next      Cancel

#### Security problems:

- 1) After entering the correct security answer and the new password, click the "Next" button.
- 2) Change your password.

3) If no new password is entered, the original password will not be changed after the security answer is verified.

(3) Delete security problems: In case that security problems are set, clicking the "Security problems" button will enter the security problems setting interface. In this case, no security problem can be set. Instead, the original security problems shall be deleted. You can click the "Delete" button to delete the original security problems, as shown in the figure below:

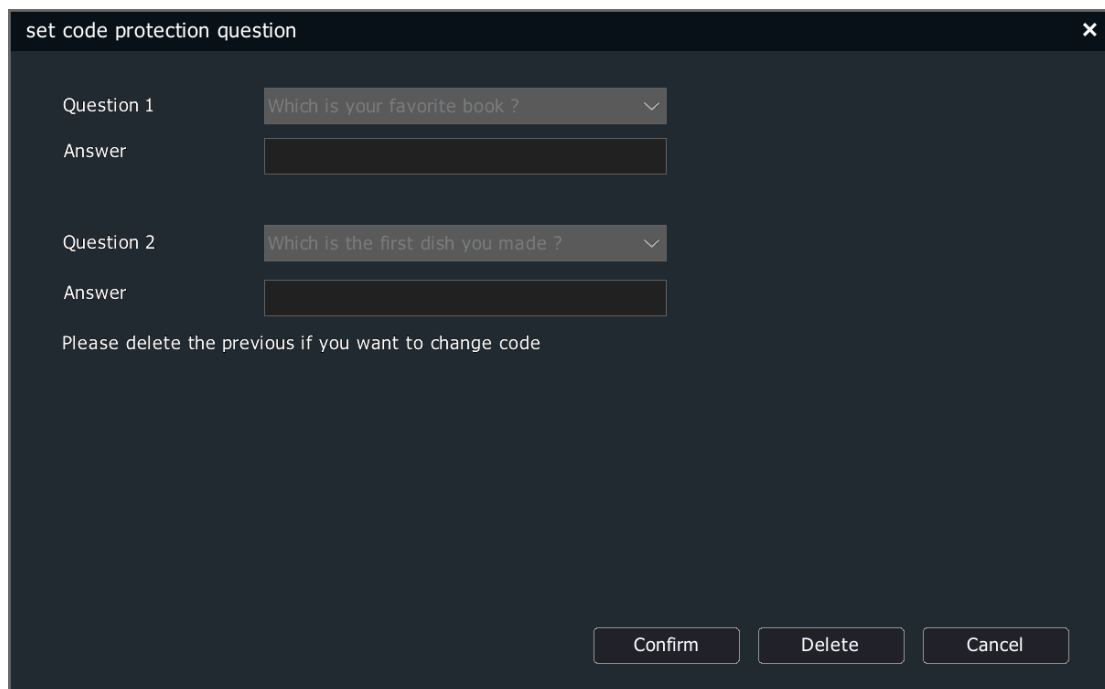

set code protection question

Question 1 Which is your favorite book ?

Answer

Question 2 Which is the first dish you made ?

Answer

Please delete the previous if you want to change code

Confirm Delete Cancel

## Device Lock

The device lock interface as shown in the figure below will appear after password unlocking fails for 5 times. The lock time will be 5 minutes.



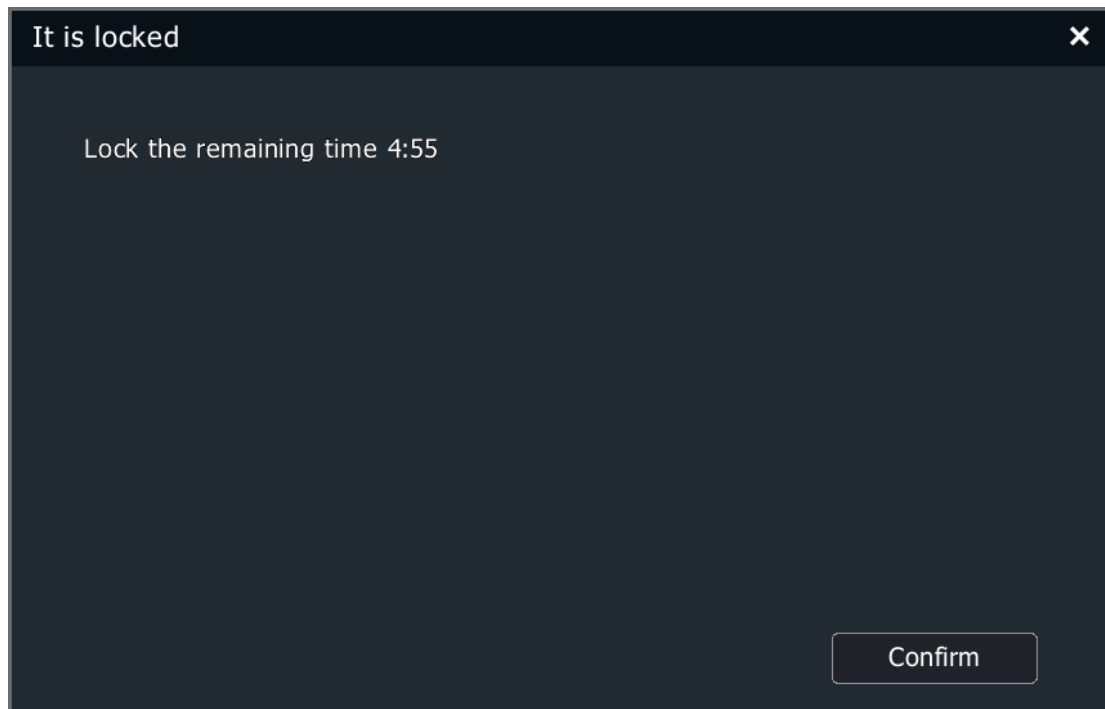

#### 4.11.8 Other Setting

##### **Video Encryption**

1. Select "Main Menu -> System Setting -> Other Setting -> Video Encryption" to enter the video encryption interface, as shown in the figure below.

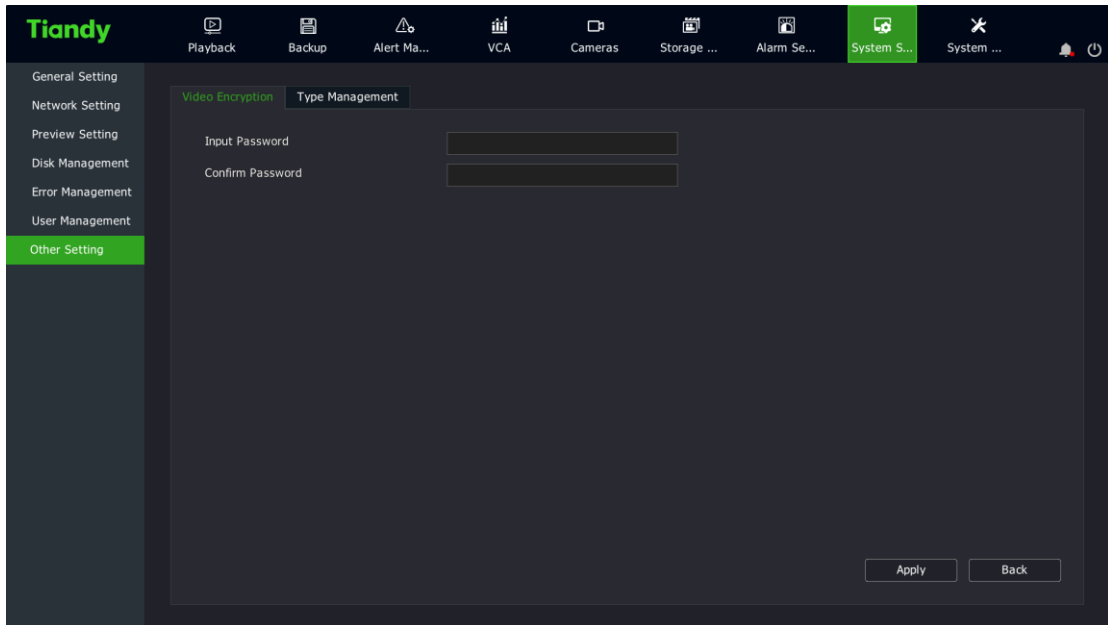

## Type Management

1. Select "Main Menu -> System Settings -> Other Settings -> Type Management" to enter the type management interface, as shown in the figure below, where you can set the video type name.

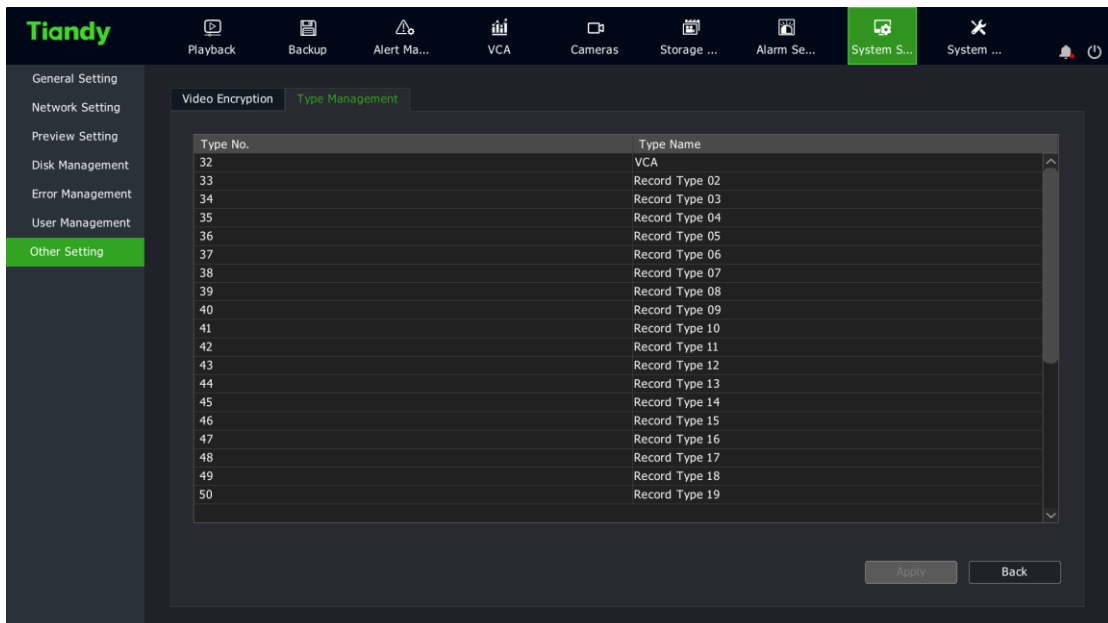

## 4.12 Alarm Setting

### 4.12.1 Alarm Input

By setting alarm inputs, when an alarm occurs in the local NVR, users can be prompted, or perform video recording, etc.

1. Select "Main Menu -> Alarm Setting -> Alarm Input" to enter the alarm input setting interface, as shown in the figure below.



2. Select the input port number to set. On the interface, users can set local and host alarm input port numbers.

3. Set the input port alias. Users can set a custom name for the current input port.

4. Choose the annunciator type.



## Notes:

- Open alarm: On when the alarm input port is open for the local NVR.
- Closed alarm: On when the alarm input port is closed for the local NVR.

5. Check "Enable" to set the alarm input arming time.

6. Enter "Activation" to set alarm linkage.

(1) Options include sound prompt, linkage Email, linkage video, linkage output, linkage snapshot, linkage PTZ, linkage text preplan, linkage single screen.

(2) After setting, parameters of other alarm input ports can be copied.

7. Click "Apply" to save the setting parameters.

### 4.12.2 Alarm Output

1. Select "Main Menu -> Alarm Setting -> Alarm Output" to enter the alarm output setting interface, as shown in the figure below.

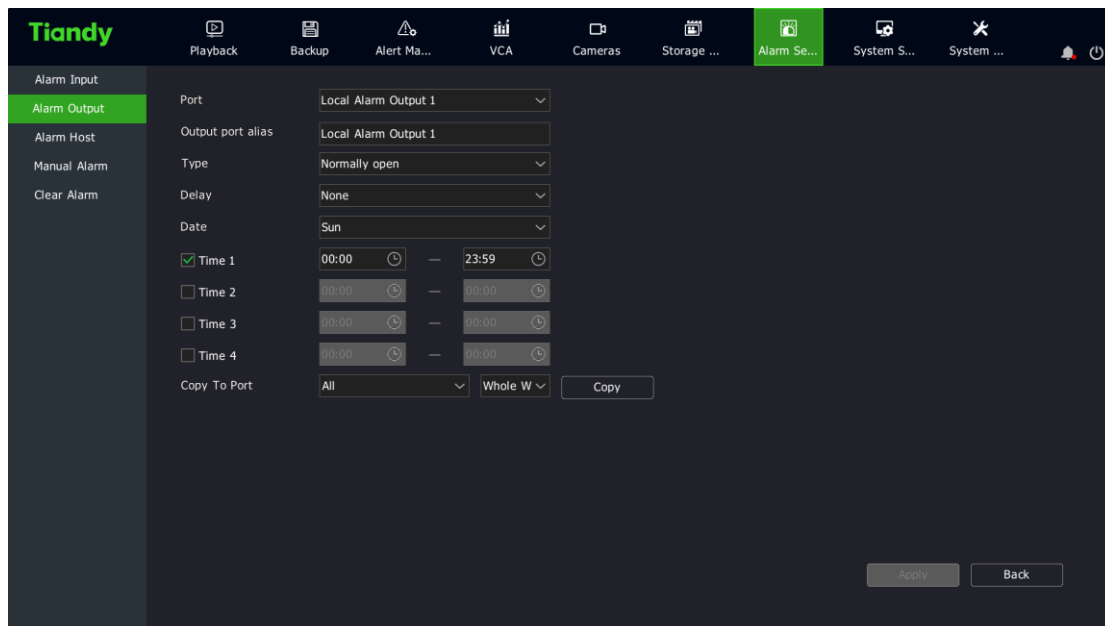

2. Select the output port number to set. On the interface, users can set the local and host alarm output port numbers.

3. Set the output port alias. Users can set a custom name for the current output port.

4. Choose the annunciator type. The type must meet the requirements of the input signal of the external device on the alarm output port.

#### Notes:

- Open alarm: Under normal circumstances, the alarm output port is closed. When there is an alarm in the system and the linked output port acts, the alarm output port is open.

- Closed alarm: Under normal circumstances, the alarm output port is open. When there is an alarm in the system and the linked output port acts, the alarm output port is closed.

5. Set signal delay time. The signal delay of the alarm output port can be set according to the actual needs.

6. Set alarm output arming time. The arming date is used in conjunction with the time period.

7. Copy to port. After setting, the parameters of other alarm output ports can be copied.

8. Click "Apply" to save the setting parameters.

### 4.12.3 Alarm Host

The alarm host is added to expand alarm I/O ports on the basis of the local alarm I/O ports. If both network alarm host and serial alarm host are added, the port number of the network alarm host is smaller than that of the serial alarm host.

#### **Network Alarm Host**

1. Select "Main Menu -> Alarm Setting -> Alarm Host -> Network Alarm Host" to enter the network alarm host setting interface, as shown in the figure below.

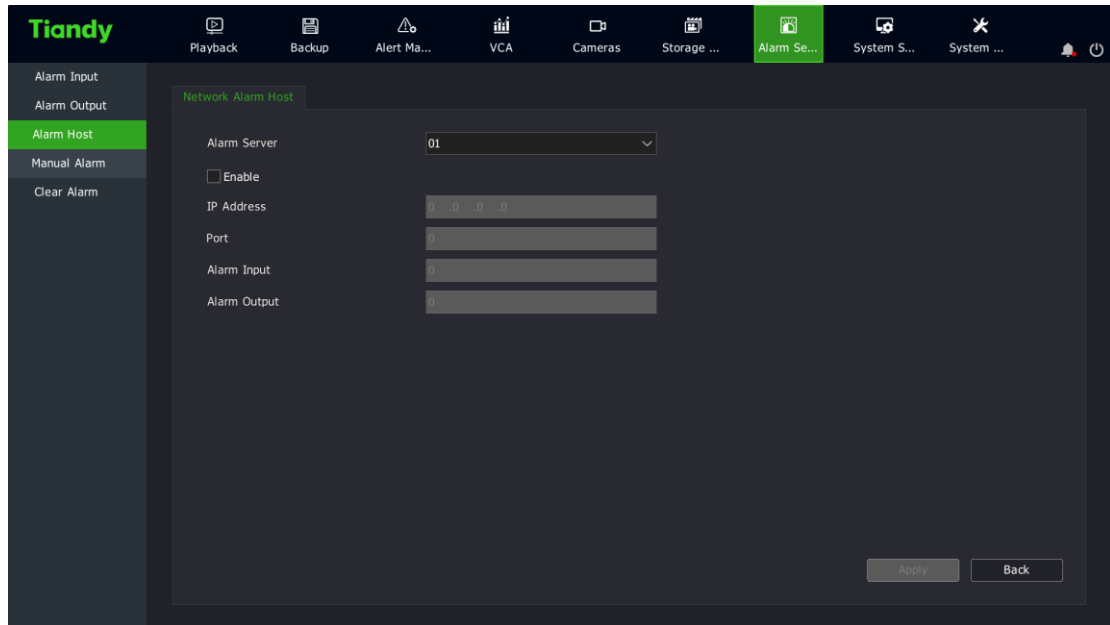

2. Set a number for the network alarm host.
3. Check "Enable" to enable the network alarm host.
4. Set the IP address of the network alarm host.
5. Set the communication port of the network alarm host, which is limited to 18803. Only when the alarm host port number in the network alarm host IE is also set to 18803 can communication be normal.
6. Set the number of alarm input ports of the network alarm host.
7. Set the number of alarm output ports of the network alarm host.

### **Serial Port Alarm Host**



1. Select "Main Menu -> Alarm Setting -> Alarm Host -> Serial Alarm Host" to enter the serial alarm host setting interface, as shown in the figure below.

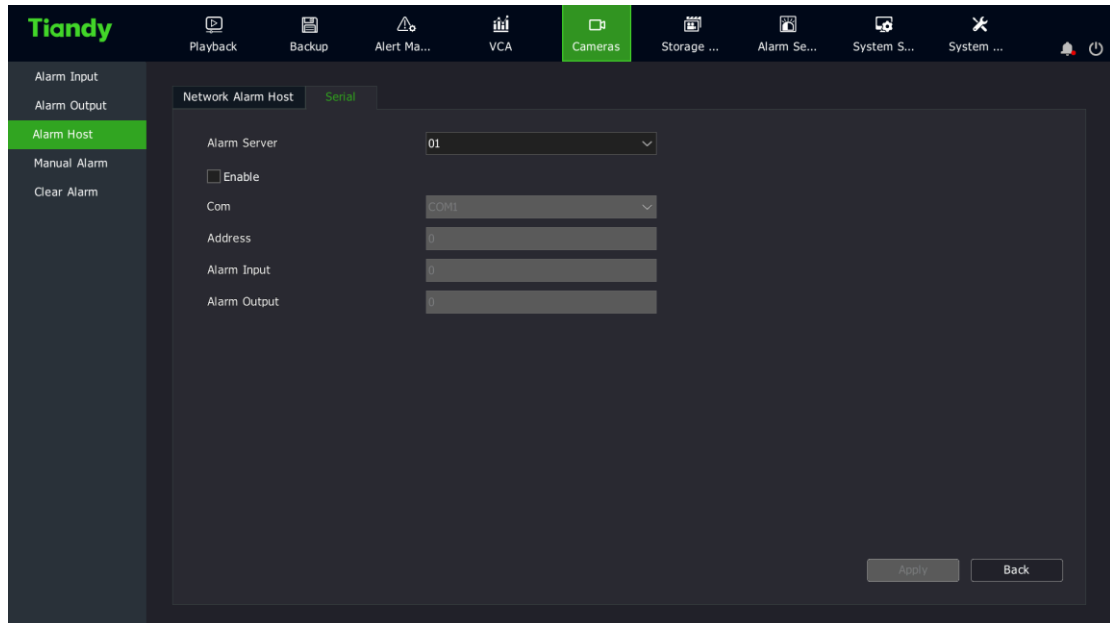

2. Set a number for the serial alarm host.
3. Check "Enable" to enable serial alarm host.
4. Set the serial port number for the serial alarm host.
5. Set the address for the serial alarm host.
6. Set the number of alarm input ports of the serial alarm host.
7. Set the number of alarm output ports of the serial alarm host.

#### 4.12.4 Manual Alarm

1. Select "Main Menu -> Alarm Setting -> Manual Alarm" to enter the manual alarm setting interface, as shown in the figure below.

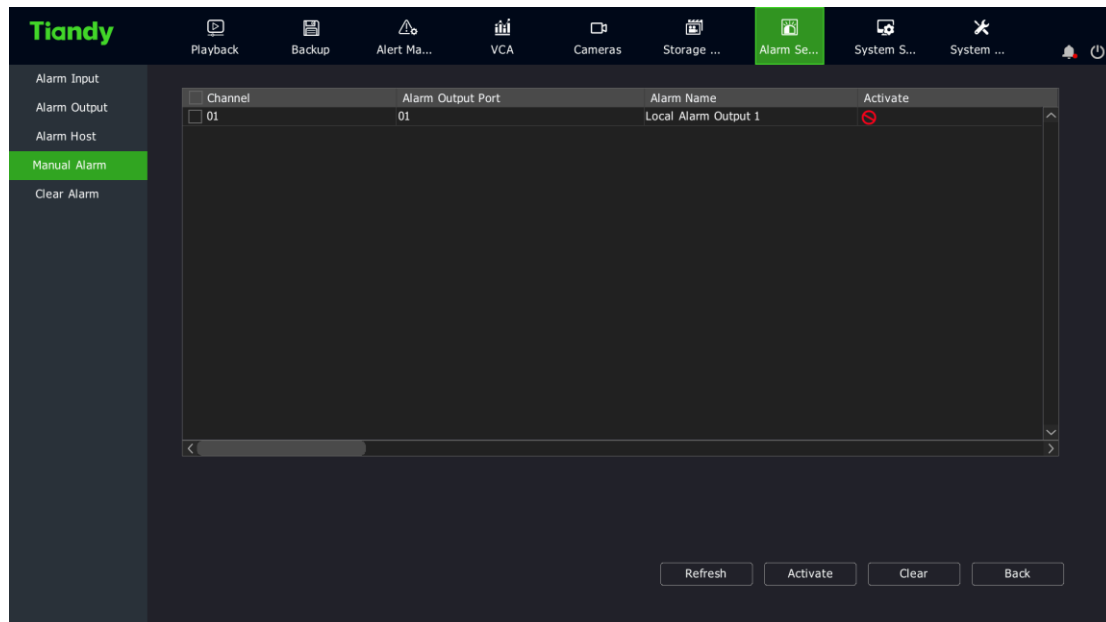

2. Select an alarm output port and click the "Trigger" or "Clear" for triggering or clearing. The alarm output port status bar shows the current status of the port. Click "Trigger All" or "Clear All" to trigger or clear all alarm output ports in the list. Click the "Refresh" button to get current property and status of the alarm output port.

#### 4.12.5 Clear Alarm

1. Select "Main Menu -> Alarm Setting -> Clear Alarm" to enter the manual clearing setting interface, as shown in the figure below.

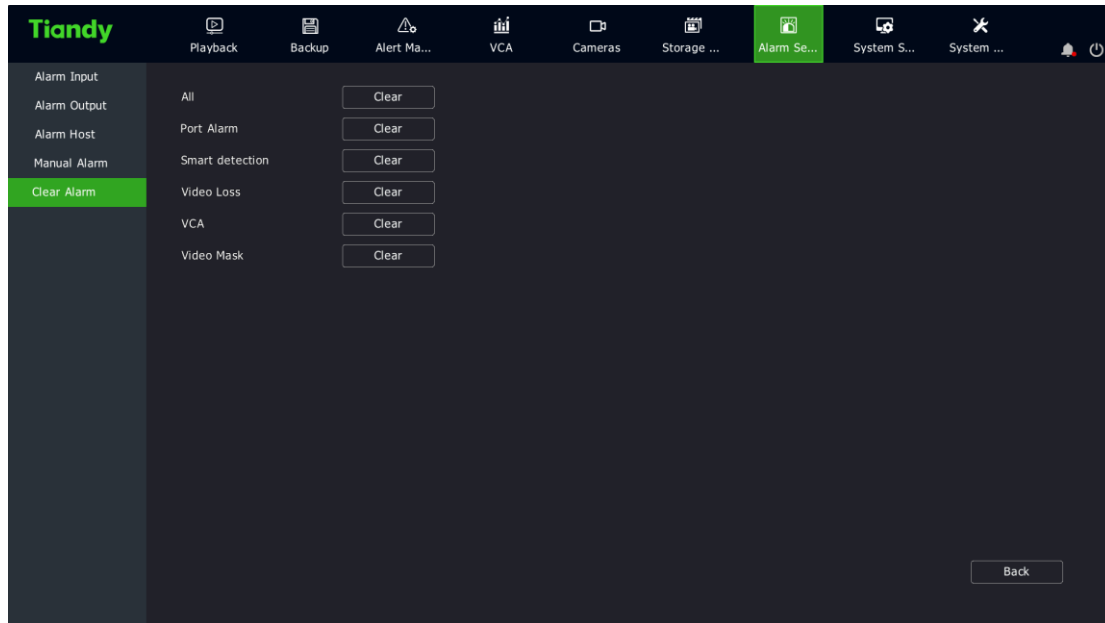

2. Select the alarm type to clear from the manual clearing interface. Options include "All", "Port Alarm", "Motion Detection", "Video Loss", "Intelligent Analysis", and "Video Occlusion". Click the corresponding button to clear this alarm type.

## 4.13. Alert Management

### 4.13.1 Early-warning Configuration

1. Enter "Main Menu -> Warning Management -> Front-end Config", as shown in the figure below.

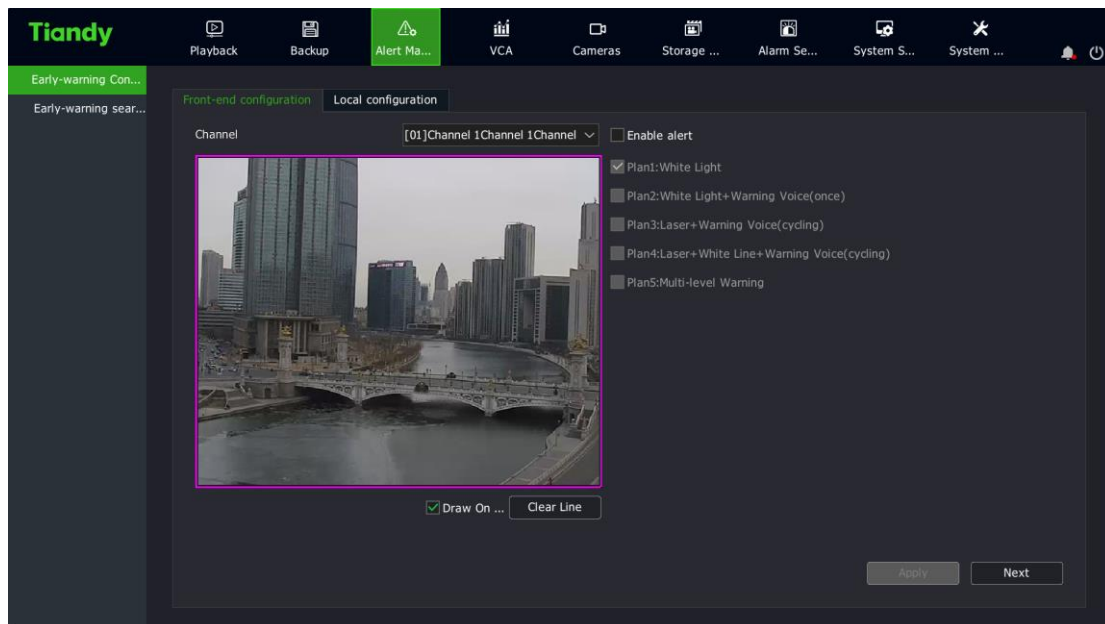

2. Users can set warning parameters according to the actual situation or their preferences

3. Plan setting, as shown in the figure below:

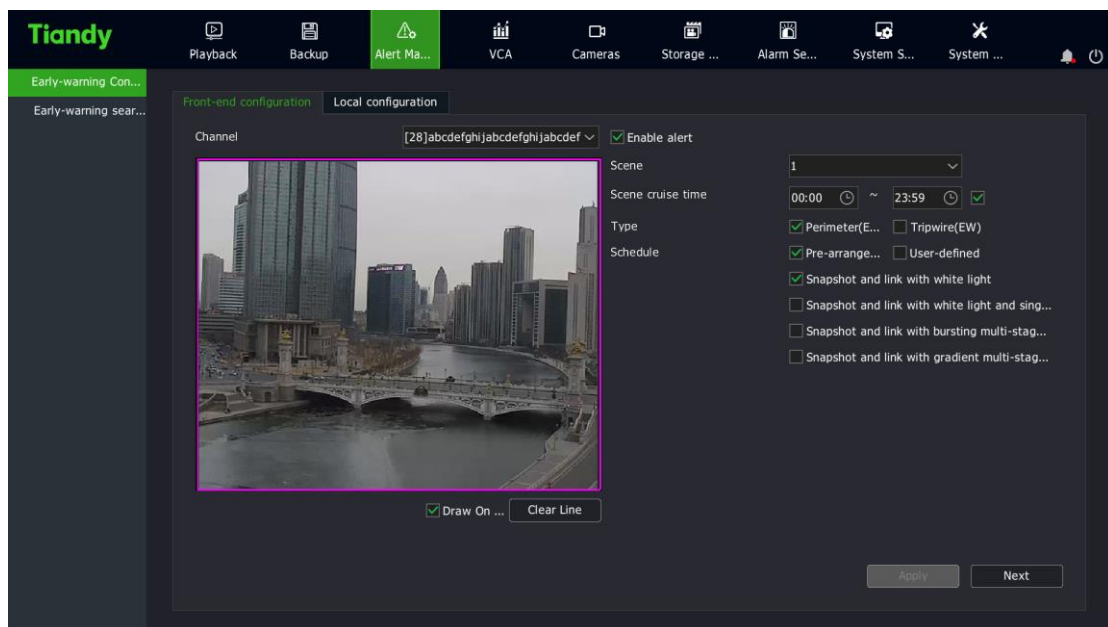

(1) Check "Enable alert" .

(2) Select warning type: perimeter warning or tripwire warning, and set the effective time of warning scene.

(3) Adjust the scene and draw a warning area or warning line. By default, the full screen of perimeter warning is the warning area. To adjust, clear lines and draw again.

(4) Select a preset warning plan.

(5) Click the "Save" button to complete the algorithm setting, and exit the alarm setting interface to make the settings effective.

4. Customize settings, as shown in the figure below:

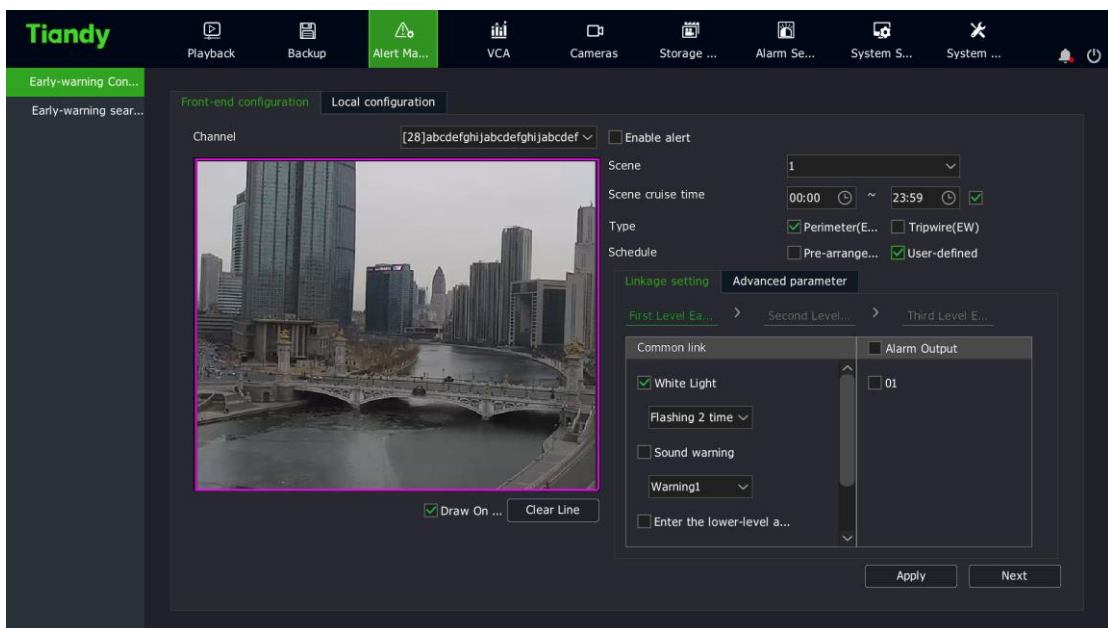

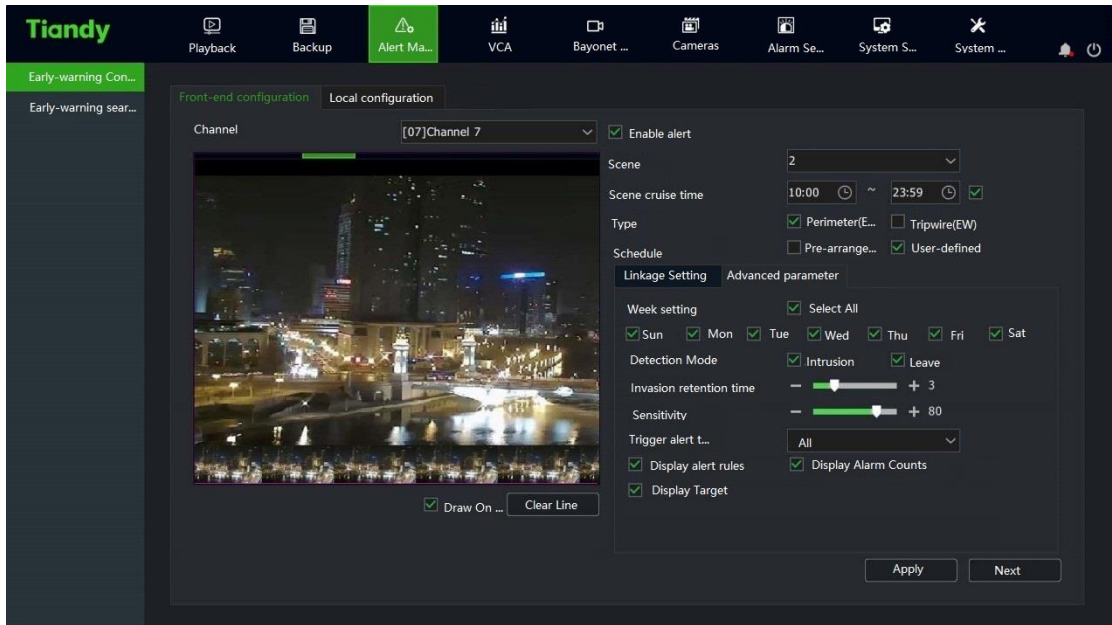

- (1) Check "Enable effective warning algorithm" .
- (2) Select warning type: perimeter warning or tripwire warning, and set the effective time of warning scene.
- (3) adjust the scene and draw a warning area or warning line.
- (4) Select Custom for warning template.
- (5) Set linkage items or advanced parameters. Of them, up to three-level warning can be set for linkage item settings, and the warning effect at each level can be set separately.
- (6) Click the "Save" button to complete the algorithm setting, and exit the alarm setting interface to make the settings effective.



- Four scenarios are supported for the device. The above steps can be used to set multiple scenes, and scene cruise of different warning types or different linkage items can be realized by setting different cruise periods.
- The "exploded multi-level audible and visual warning" in perimeter warning works as follows: After a target enters the warning area, the white light flashes strongly and the voice prompt is given. The next level mode is enabled after reaching the retention time, and the linkage laser is switched on.
- The "progressive multi-level audible and visual warning" plan works as follows: It is divided into three levels by default, and the warning effect is enhanced step by step. When the retention time in the previous level is greater than the set value, the next level is enabled.
- Up to three levels of linkage can be set for linkage setting in the custom template. The linkage items can be set separately in each level. Among them, linkage tracking and entering the next warning level are mutually exclusive. When the linkage tracking is selected, the next warning level will not be enabled. When linkage tracking is selected, the tracking multiplier shall be set. Adjust the

angle and multiplier to determine an appropriate proportion when a target is in the picture when the monitoring scene is furthest. It is recommended that the target occupies more than 1/2 of the picture height. Click to set the tracking multiplier.

- The normally-on option of linkage white light in linkage setting means that when an alarm occurs, the white light is turned on, and off when the alarm is cleared.
- Advanced parameters in the custom template include arming weekday, detection mode, trigger alarm target, trigger sensitivity, maximum tracking time, display rules and target frame settings.
- Warning types are divided into perimeter warning and tripwire warning, which are aimed at intrusion zone, departure zone and crossing behavior. By default, the perimeter warning is an intrusion zone warning, and users can modify the detection mode in the advanced settings of the custom template.
- Warning detection target is people by default. Users can perform settings in Advanced Settings according their needs.
- The maximum tracking time is effective when the linkage tracking is enabled, which means that tracking action stops and warning monitoring scene returns when the time is reached. The default is



300 seconds. When it is set to 0 seconds, the dome camera will keep tracking until the target disappears.

#### 4.13.2 Local Configuration of Early-warning Configuration

Enter the "Main Menu -> Alert Management -> Early-warning Config -> Local Configuration" interface, as shown in the figure below.

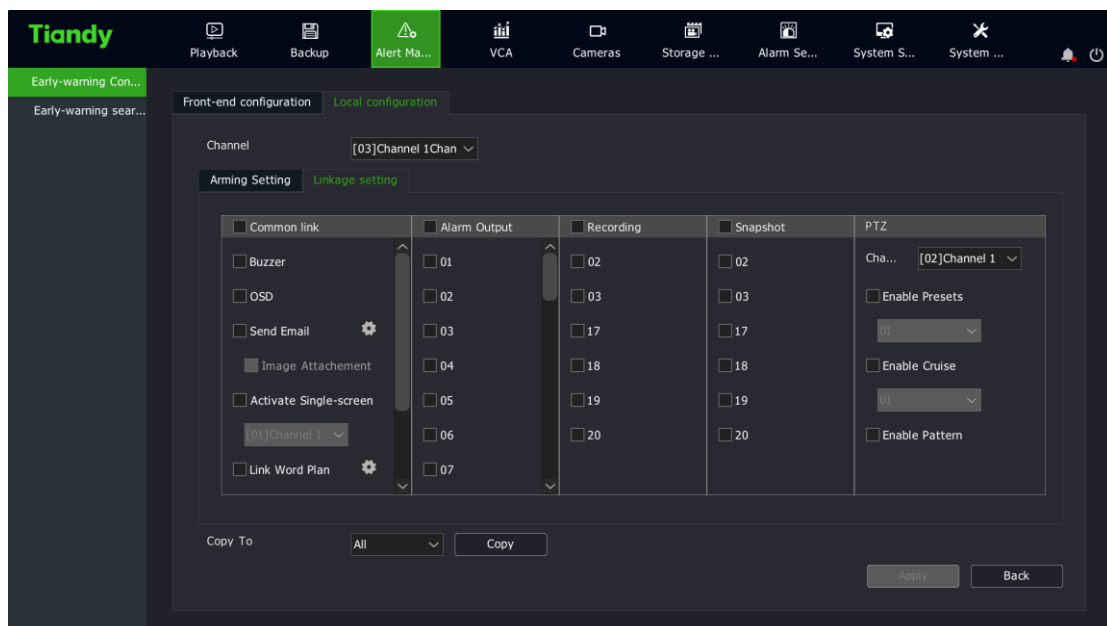
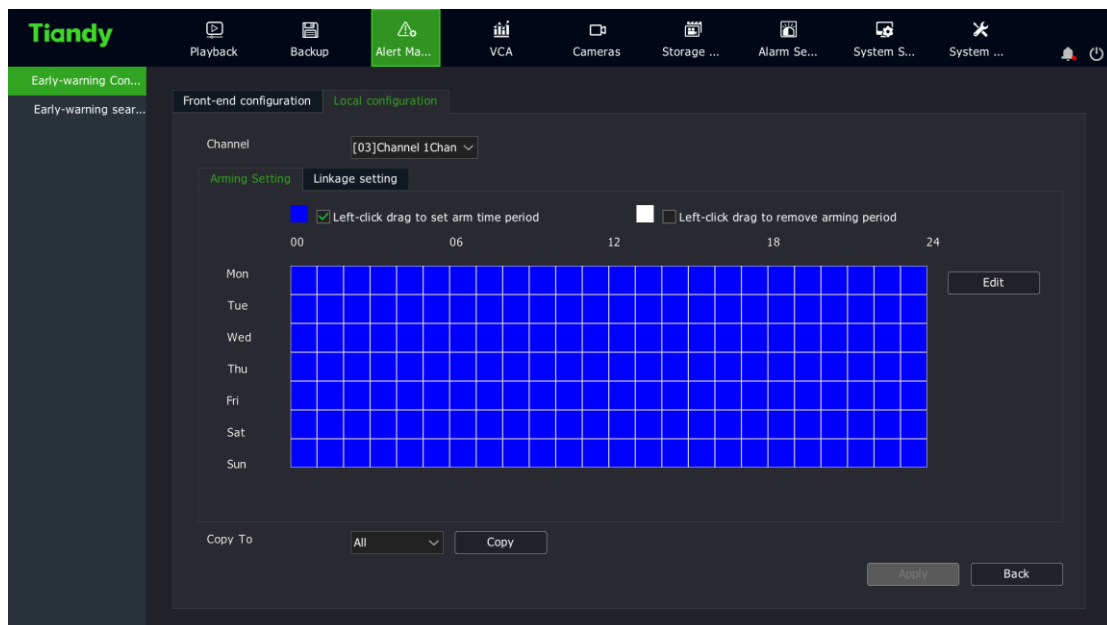

(1) The arming time can be set on the arming setting interface.

(2) Enter "Linkage Setting" to set alarm linkage. Options include voice prompt, screen display, linkage video, linkage alarm output, linkage PTZ, linkage snapshot, etc.

### 4.13.3 Early-warning Search

1. Enter the "Main Menu -> Alert Management -> Early-warning Search" interface, as shown in the figure below.

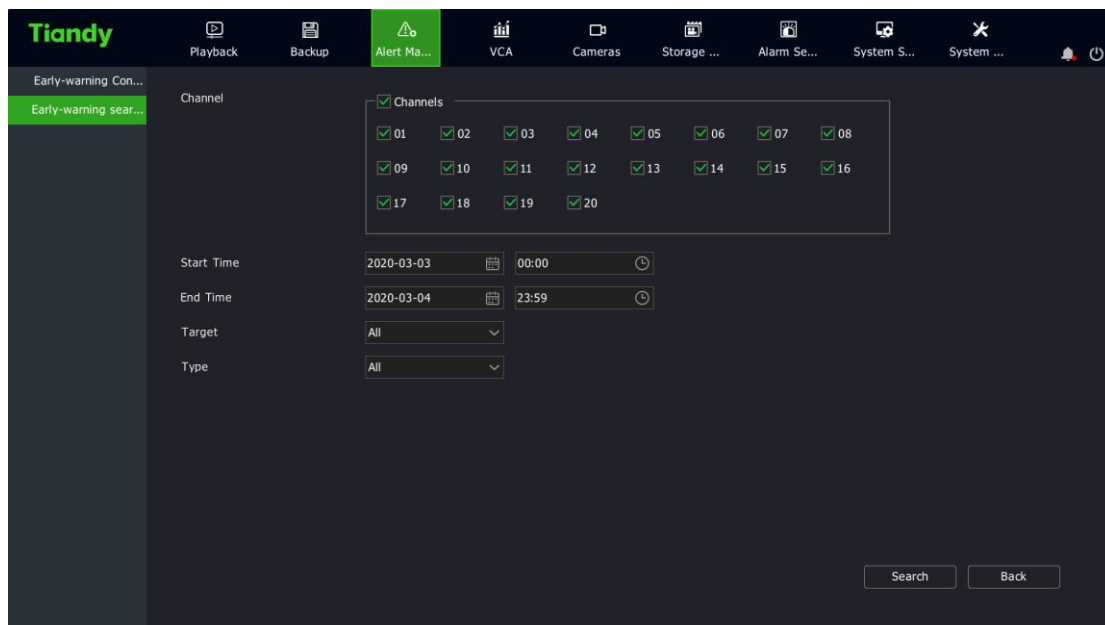

2. Retrieval targets are divided into all, people, cars and others; types are: all, tripwire, perimeter - intrusion, perimeter - departure. Select the corresponding target and type and click the Search button to retrieve the corresponding warning data, as shown in the figure below:

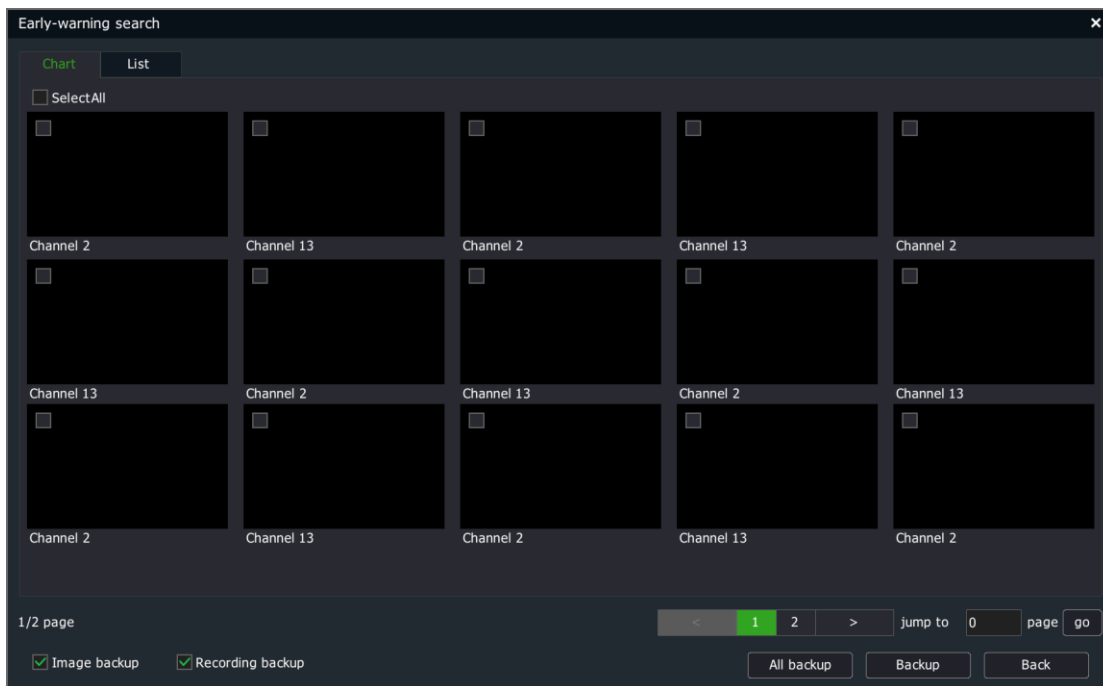
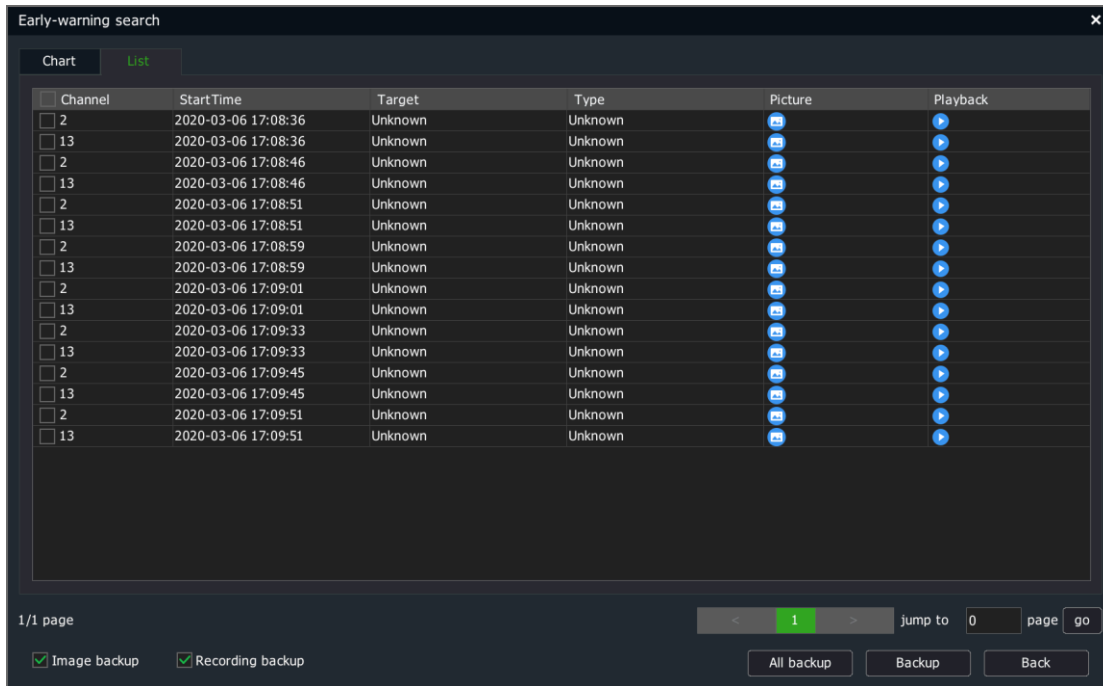

## 4.14. VCA

### 4.14.1 Smart Config

1. Enter the "Main Menu ->VCA -> Smart Config" and select the "Event Selection" tab, as shown in the figure below.

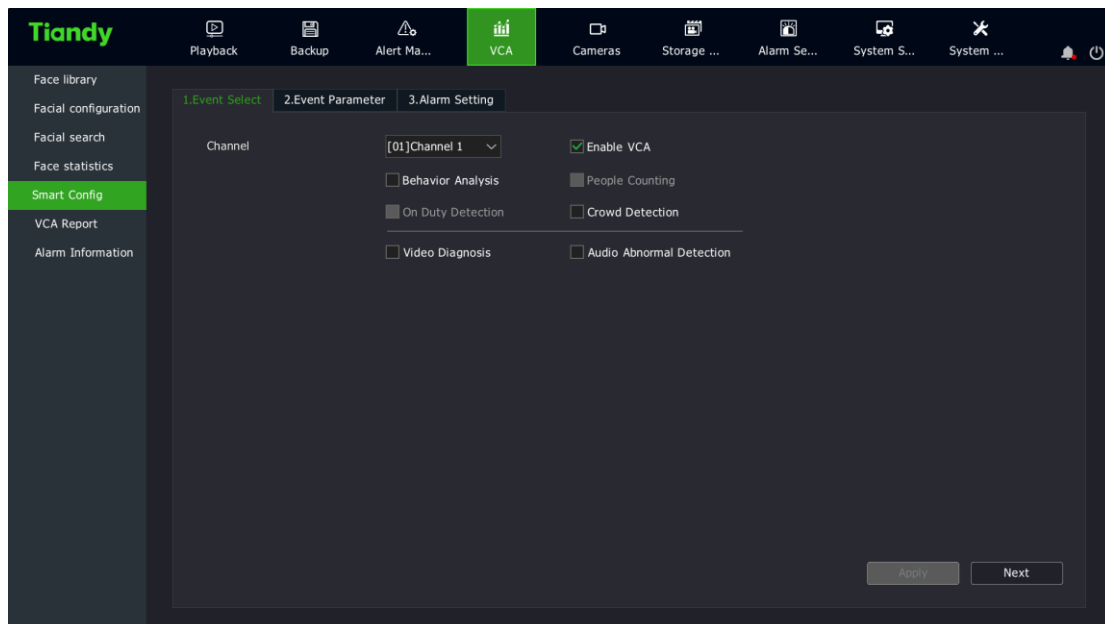

2. Select the channel to set.
3. Select whether to enable front-end intelligent analysis.
4. Check the algorithm.
5. Click the "Save Algorithm" button to save algorithm configurations.



**Note:**

- Illegal parking and linkage tracking features are available for only some models. The real product shall prevail.

#### 4.14.2 Event Parameters

1. Enter the "Main Menu -> VCA -> Smart Config", and select the "Event Parameters" tab, as shown in the figure below.

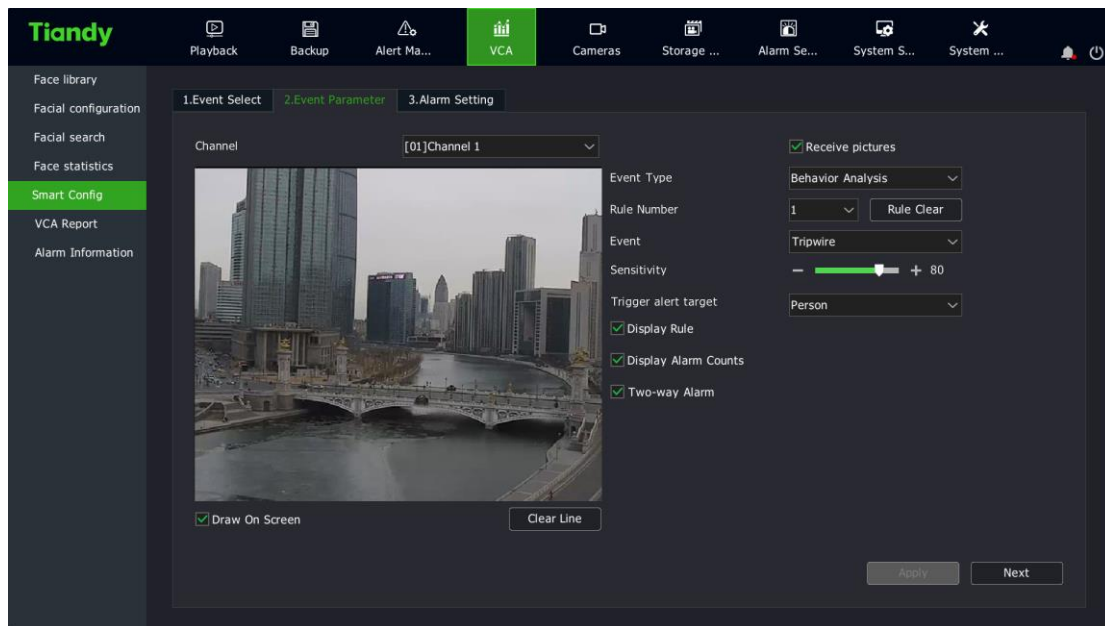

## 2. Intelligent analysis parameter setting:

- Rule No. : Select the rule for intelligent analysis. Up to 8 rules are supported for each channel.
- Receive pictures: Whether to receive pictures.
- Event: Selects intelligent analysis events. Options include tripwire, double tripwire, perimeter, abandoned object, object loss, wander, run, stop, warning, heat map, etc.
- Sensitivity: When the whole target enters the alarm area exceeding the proportion set, the alarm will be triggered. The sensitivity is between 0 and 100.
- Display rule: Displays rule information on the video.

- Display alarm count: Displays the alarm count on the video, and alarms are accumulated one by one.

3、Select “Enable line” to start the line setting area for this rule, and click "Clear line” to clear the border set on the video.

 **Note:**

- The event type of behavior analysis is dynamically changed according to the algorithm supported by the front end.

### 4.14.3 Alarm Setting

1. On the event parameter interface, click "Next" to set alarm linkage, as shown in the figure below.

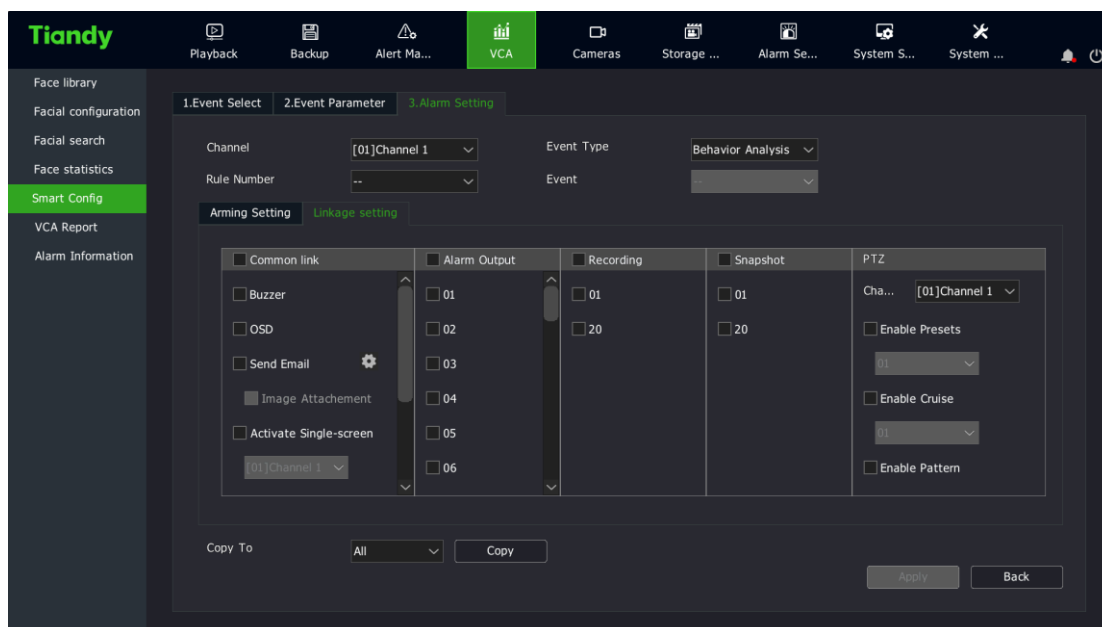

(1) Select the rule number to set.

(2) Set the arming time on the arming setting interface.

(3) Enter "Linkage Setting" to set intelligent analysis alarm linkage. Options include voice prompt, screen display, linkage video, linkage alarm output, linkage PTZ, linkage snapshot, etc.

(4) When the algorithm is selected as heat map, only the arming time can be set, as shown in the figure below.

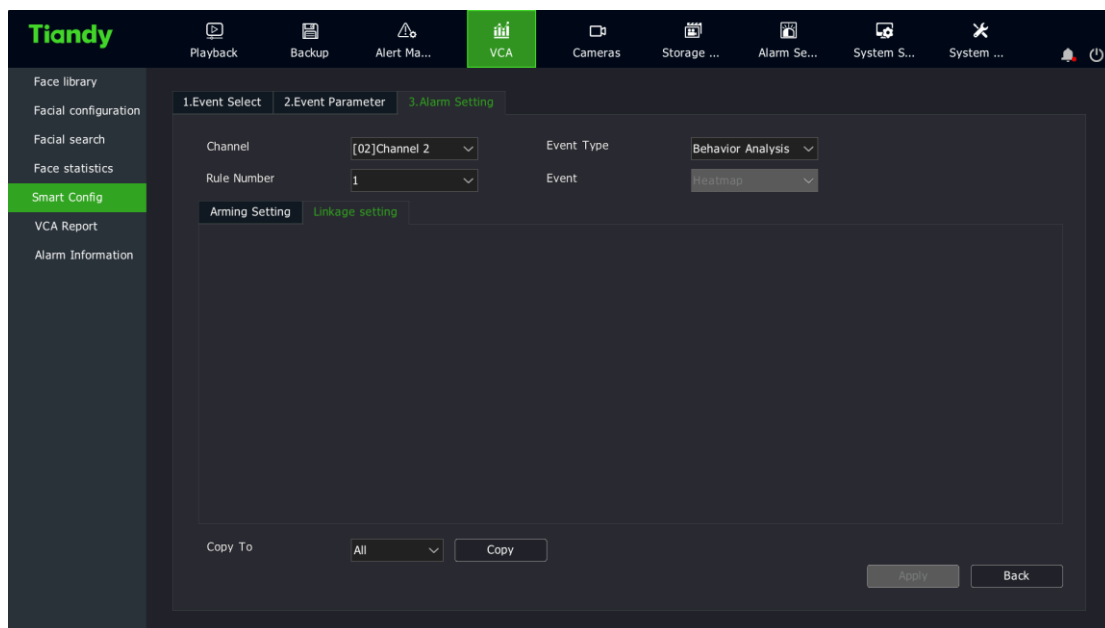

(5) After setting is completed, the parameters of other channels can be copied.

#### Notes:

- Behavior analysis can be linked to the voicing system and front-end; Illegal parking can only be linked to the front end; Other algorithms cannot be linked to the front end and the voicing

system. When linkage to the voicing system is set, it is linked to the single screen of this channel by default.

- Linkage to the front end is available for some front ends. The real product shall prevail.

2、 Click Apply to save the settings.

#### 4.14.4 VCA Report

1. Enter the "Main Menu -> VCA -> VCA Report", select the "People Counting" tab, select the channel number and report type, click the "Statistics" button for traffic statistics, display the statistical bar graph, select the statistic time, and click "Export" to export the corresponding report.

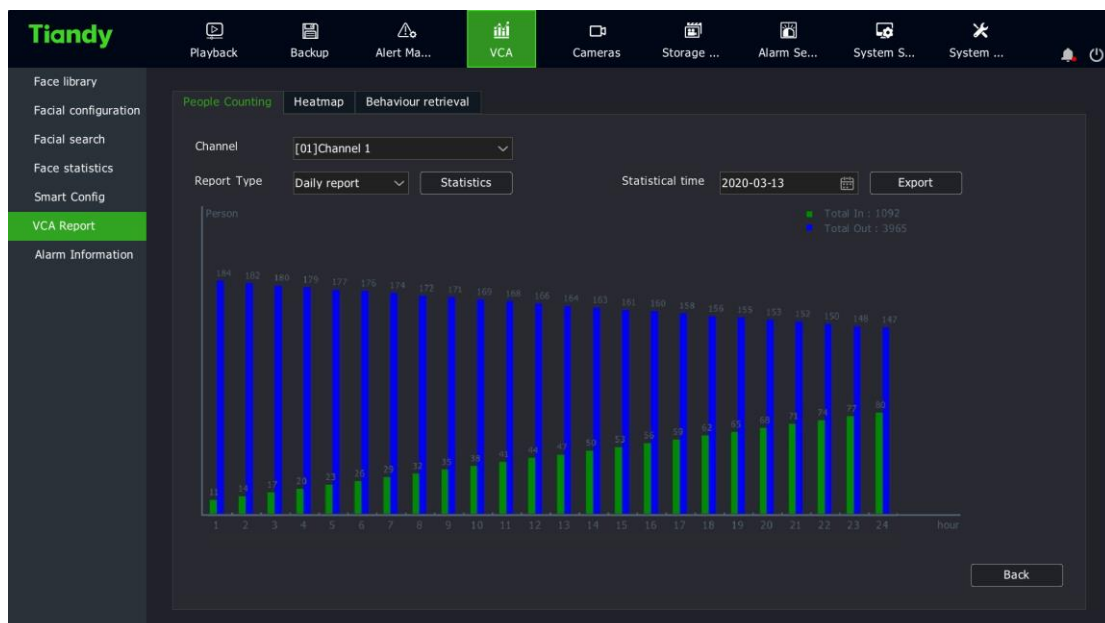



2. Enter the "Main Menu ->VCA -> VCA Report", and select the "Heatmap" tab, as shown in the figure below. Select the channel number and report type, and click the "Statistics" button to conduct heat map statistics by space or time, and display the imaging map or line graph. Click "Export" to export the corresponding picture or report.

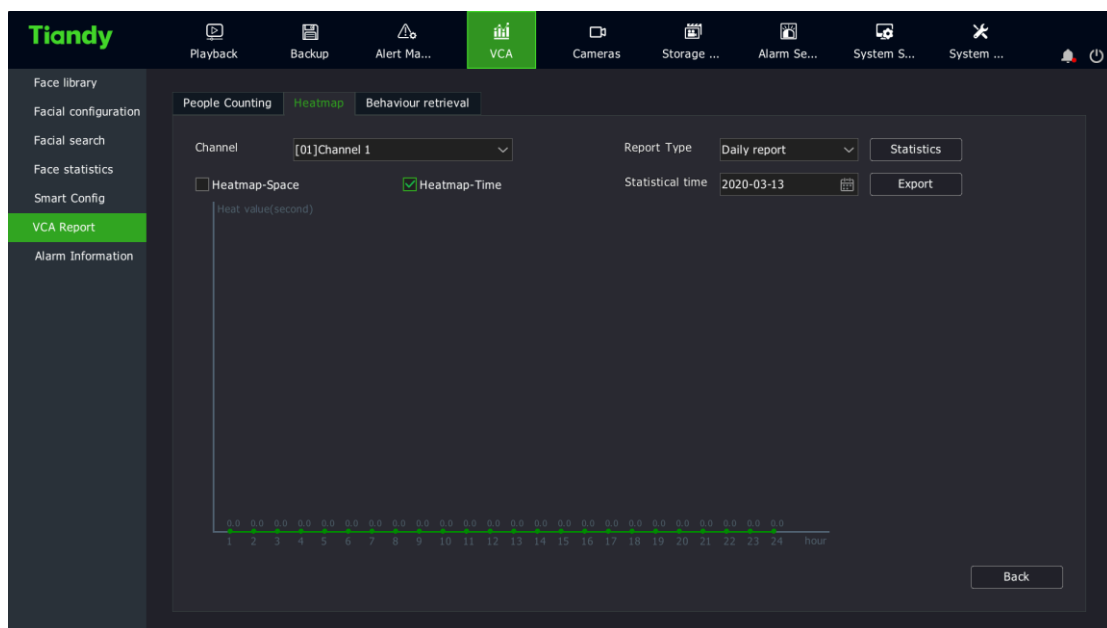
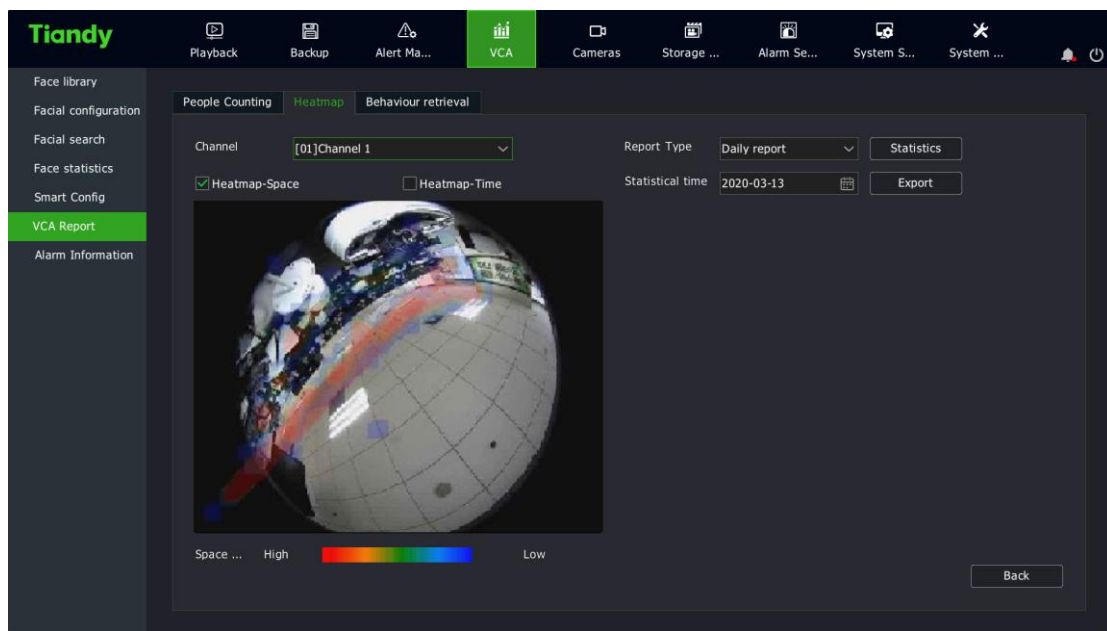

3. Enter the "Main Menu -> VCA -> VCA Report" interface, and select the "Behavior Retrieval" tab, as shown in the figure below.

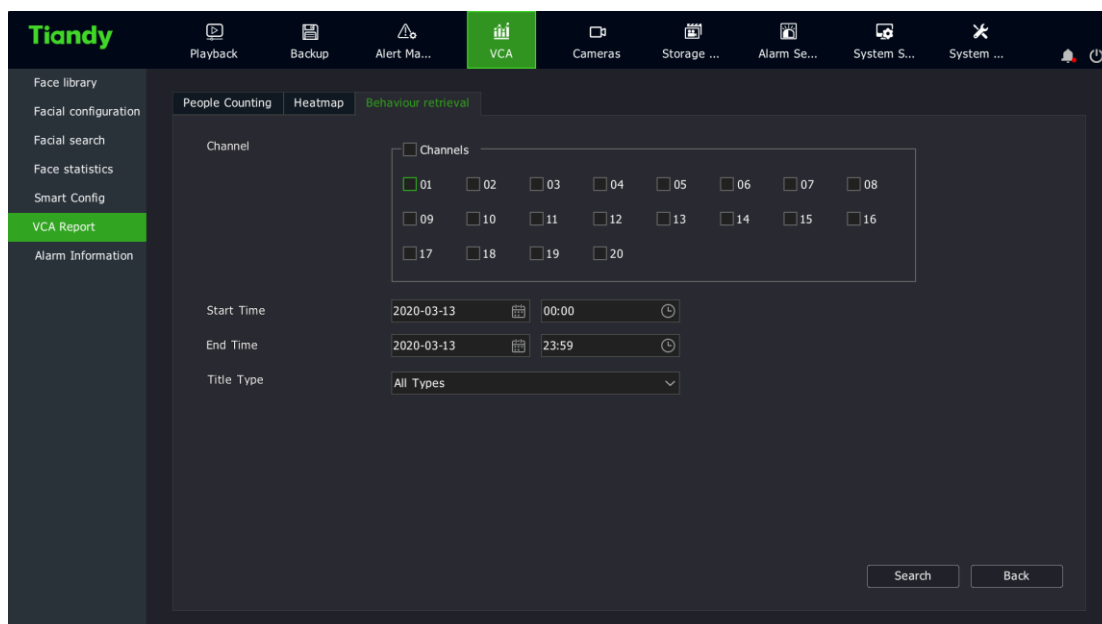

Select the channel, set the start date and time, select the event type, and click the "Search" button to enter the "Behavior Search" interface, which is divided into graph page and list page. You can click any channel on the graph page to view videos and double click to enlarge pictures; and you can click the Playback icon on the list page to enlarge pictures, as shown in the figure below.

Behaviour retrieval

Chart **List**

Channel	StartTime	behaviour type	Playback
<input type="checkbox"/> 9	2020-03-13 00:00:27	Running	
<input type="checkbox"/> 9	2020-03-13 00:00:30	Running	
<input type="checkbox"/> 9	2020-03-13 00:00:38	Parking	
<input type="checkbox"/> 9	2020-03-13 00:00:42	Running	
<input type="checkbox"/> 9	2020-03-13 00:00:42	Parking	
<input type="checkbox"/> 9	2020-03-13 00:01:26	Running	
<input type="checkbox"/> 9	2020-03-13 00:01:35	Object Missing	
<input type="checkbox"/> 9	2020-03-13 00:01:35	Parking	
<input type="checkbox"/> 9	2020-03-13 00:01:37	Object Missing	
<input type="checkbox"/> 9	2020-03-13 00:01:37	Object Missing	
<input type="checkbox"/> 9	2020-03-13 00:01:38	Object Missing	
<input type="checkbox"/> 9	2020-03-13 00:02:40	Running	
<input type="checkbox"/> 9	2020-03-13 00:07:05	Running	
<input type="checkbox"/> 9	2020-03-13 00:07:18	Running	
<input type="checkbox"/> 9	2020-03-13 00:07:25	Running	
<input type="checkbox"/> 3	2020-03-13 00:09:21	Perimeter	
<input type="checkbox"/> 9	2020-03-13 00:11:41	Running	
<input type="checkbox"/> 9	2020-03-13 00:11:42	Running	
<input type="checkbox"/> 9	2020-03-13 00:11:45	Running	
<input type="checkbox"/> 9	2020-03-13 00:14:06	Running	
<input type="checkbox"/> 9	2020-03-13 00:14:15	Object Missing	
<input type="checkbox"/> 9	2020-03-13 00:14:15	Object Missing	

1/74 page

< 1 2 3 4 ... 74 > jump to 0 page go

Image backup  Recording backup

All backup Backup Back

#### 4.14.5 Management of face library

Face database management is intended for managing original face images by groups. Existing face database is shown in tables and the base images in the selected face database are shown in graphs, as shown in the figure below.

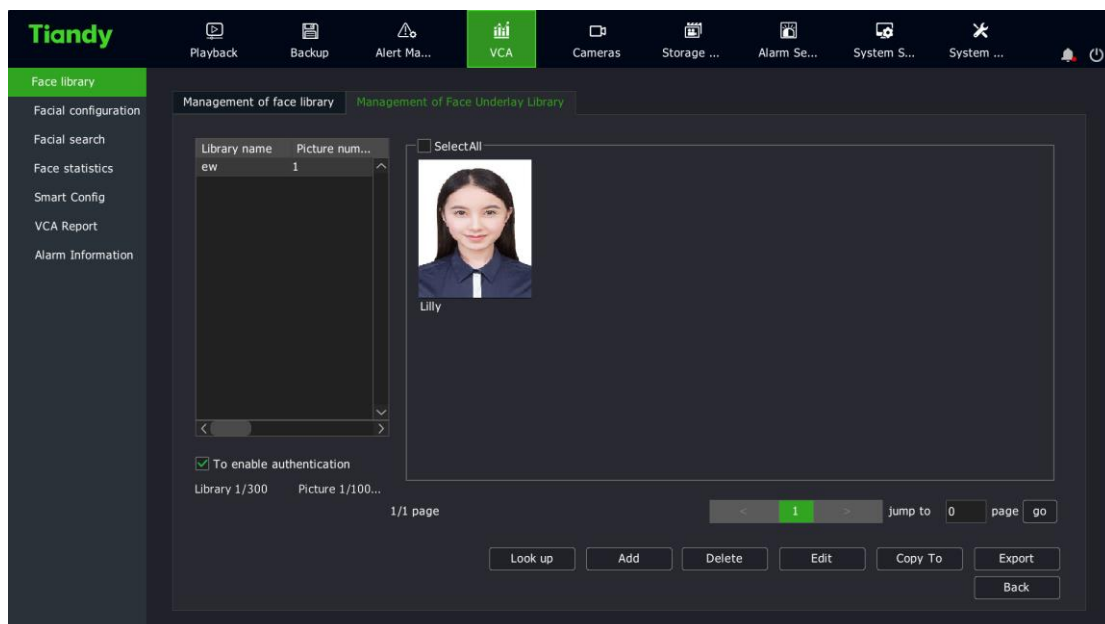
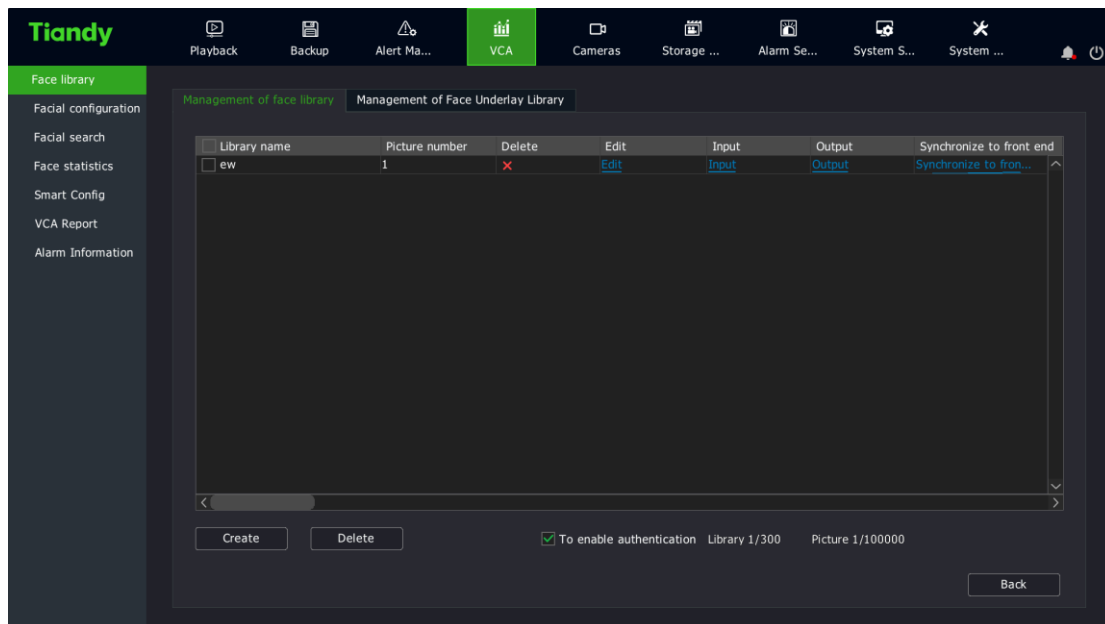

1. The existing face database data can be retrieved from the face database management and the face image library can be managed by using buttons such as "Create" and "Delete".

[Create]: Click the "Create" button to display a prompt box, where you can add the name and description of the face database. and after this, click the "OK" button to confirm your operations.

[Delete]: Select the face database to delete from the face database list, and click [Delete] to delete it.

[Set]: In the face database list, click "Set" to display a prompt box where you can modify the name and description of the face database, and after this, click the "OK" button to confirm your operations.

[Import]: In the face database list, click [Import] to import a box file containing the face database.

[Export]: In the face database list, click [Export] to export a box file containing the face database.

[Model All]: Click the "Model All" button to model all the base images in the database.

[Synchronize to Front End]: The face database in the NVR can be synchronized to the selected IPC channel. The interface is shown in the figure below:

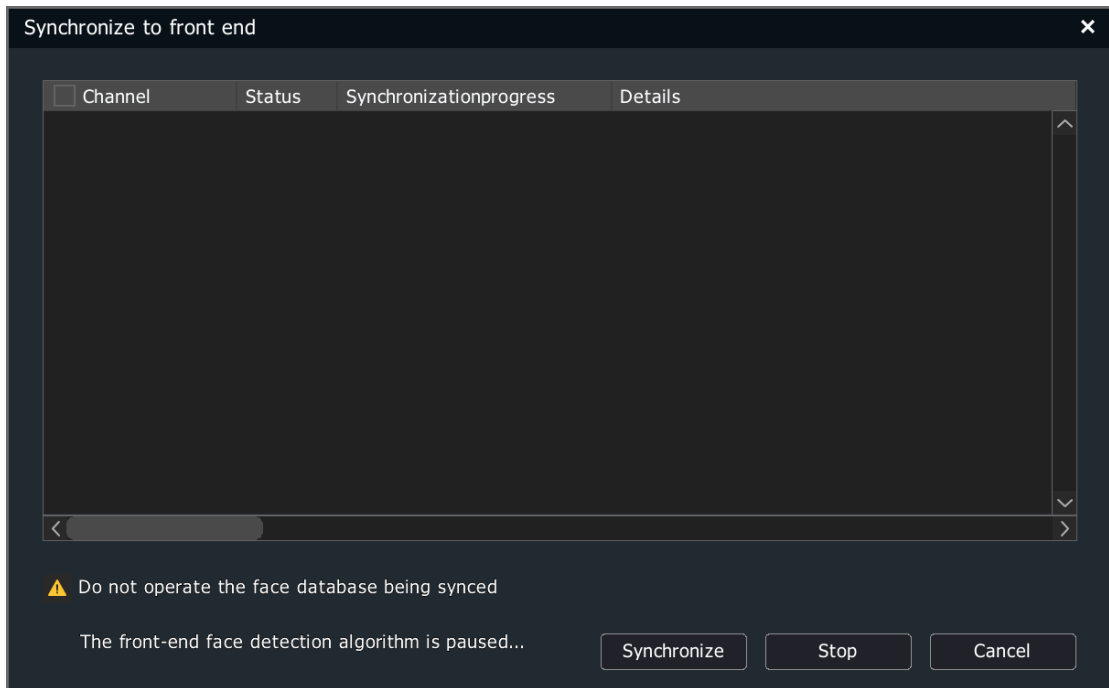

[To enable authentication]: only the administrator user can operate the face database.

2. Base image management of the face database. The original face images are the basis of face recognition algorithm. Users can use the following buttons to manage the base images.

[Search]: Allows searching of base images meeting conditions in the face database through information about base images.

[Search by Image]: You can select images from mobile devices such as USB flash drive and then find the corresponding base images in the face database.

[Add]: You can select images from mobile devices such as USB flash drive and add them to the face database. If a folder is selected, you can add the images in the folder meeting the criteria;

[Delete]: The selected base image can be deleted from the face database

[Edit]: Edit the information about the selected base image. The information includes gender, date of birth, company, country, address, ID card type and ID card number. The modeling status indicates whether the base image has been retrieved and whether it can be identified for face recognition, as shown in the figure below:

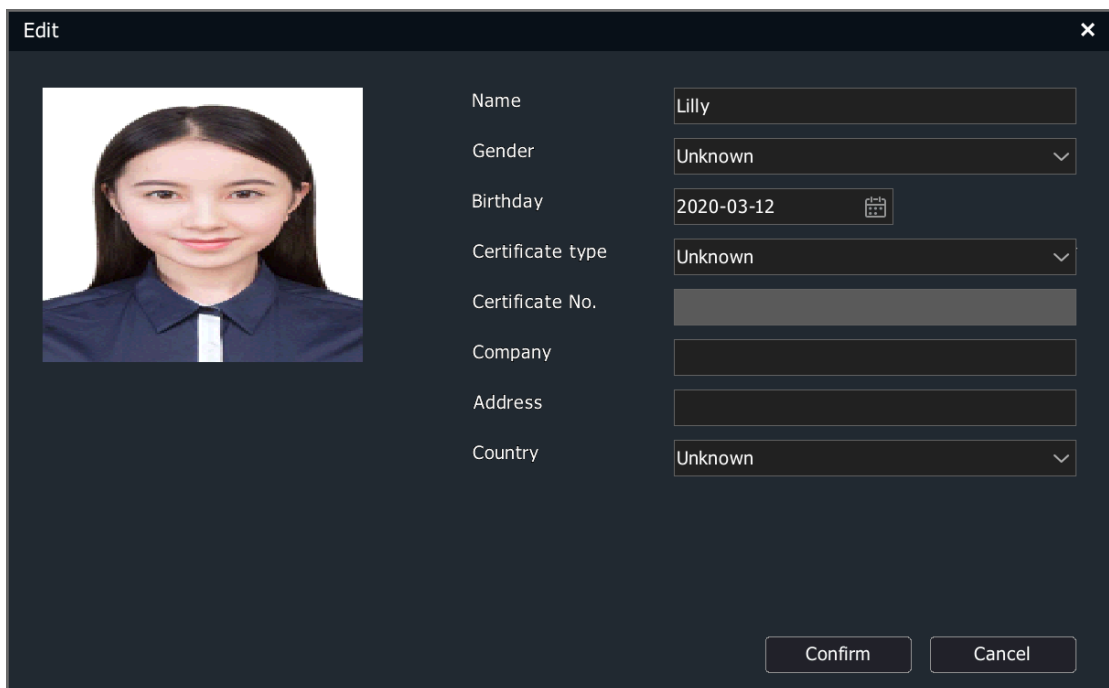

The screenshot shows a dark-themed 'Edit' dialog box. On the left is a square portrait of a woman with long dark hair wearing a dark blue collared shirt. To the right of the photo is a list of fields for editing user information:

- Name: Lilly
- Gender: Unknown (dropdown menu)
- Birthday: 2020-03-12 (calendar icon)
- Certificate type: Unknown (dropdown menu)
- Certificate No.: (empty text field)
- Company: (empty text field)
- Address: (empty text field)
- Country: Unknown (dropdown menu)

At the bottom right of the dialog are two buttons: 'Confirm' and 'Cancel'.

[Copy To]: The selected base image can be copied to other face databases.

[Export]: The selected base image can be imported to mobile devices such as USB flash drives.



**Notes:**

- The face database remains unchanged when the device is restored to defaults.
- The resolution of the added base images shall be more than 100\*100 and less than 1920\*1080.
- Up to 32 face databases can be managed. The maximum number of base images supported is subject to the real product.
- HDD shall be connected to import base images.
- It is recommended that the number of base images in a single face database should not exceed 5000.

#### **4.14.6 Face Detection**

1. Enter the "Main Menu -> VCA -> Face Configuration" and select the "Face Detection" tab, as shown in the figure below.



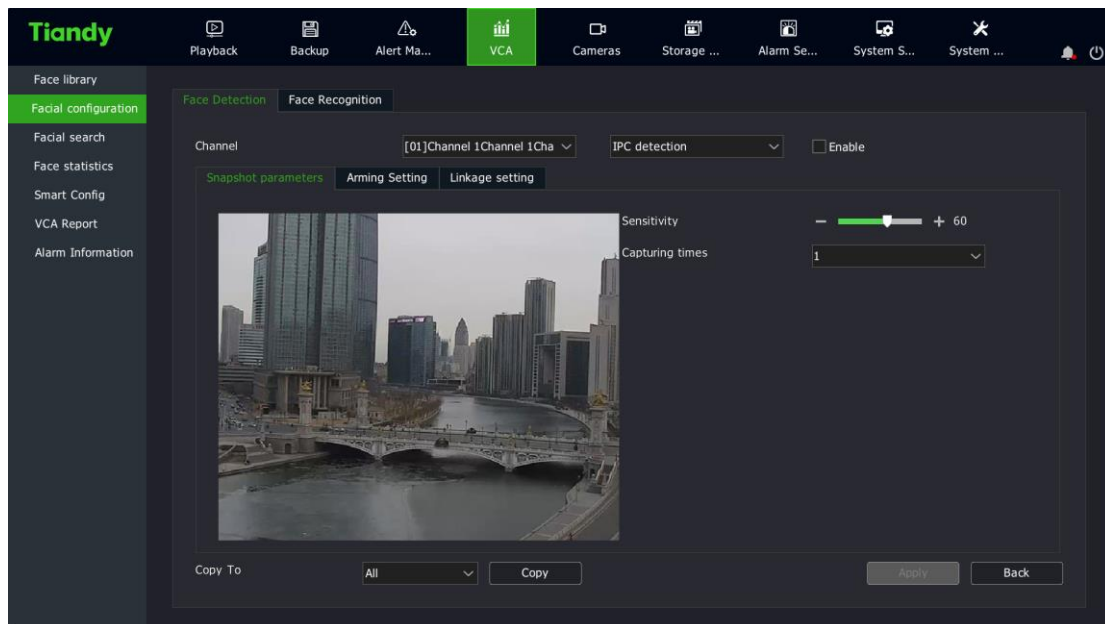

2. Select the algorithm type of face detection, and choose to enable IPC detection /NVR detection.

For IPC detection, the front-end is connected to the snapshot camera, which is used for face detection and NVR detection.

3. Set the snapshot parameters.

(1) Draw face detection area: The detection area can be set on the screen during IPC detection.

Push policy: including optimal policy and fastest policy. "Optimal Policy" is the clearest picture of a person captured from his entrance to departure. The "Fastest Policy" is to snap a picture immediately when detecting a face

Number of snapshots: The number of snapshots taken when a face is detected. 1, 2 or 3 can be set.

Snapshot mode: full snapshot mode, high quality mode and custom mode.

"Full snapshot mode" means that all images are sent to the push module by default without security boundary control and filtering by security boundary threshold.

"High quality mode" refers to filtering by security boundary threshold configured for the system by default and sending the filtered results into the push module.

"Custom mode" refers to filtering by security boundary value set by the user, and sending the filtered results into the push module.

(2) Set the maximum and minimum face size to represent the percentage of the target width on the screen.

(3) Set the sensitivity. The larger the value is, the higher the sensitivity is. The increased detection rate will increase the error detection.

4. Set the arming time.

5. Set linkage settings. Set the local alarm linkages for NVR detection.

Options include voice prompt, screen display, linkage video, linkage alarm output, linkage PTZ, linkage snapshot, etc.



**Notes:**

- Only IPC detection can be enabled when the front end is a face recognition machine.
- NVR detection uses 1080P as standard. The higher the resolution is, the number of channels decreases. The maximum number of supported channels is subject to the real product.
- The snapshot parameters of IPC detection are changed dynamically according to the algorithm supported by the front end.

#### 4.14.7 Face Configuration

1. Enter the "Main Menu -> VCA -> Face Configuration" and select the "Face Recognition" tab, as shown in the figure below.

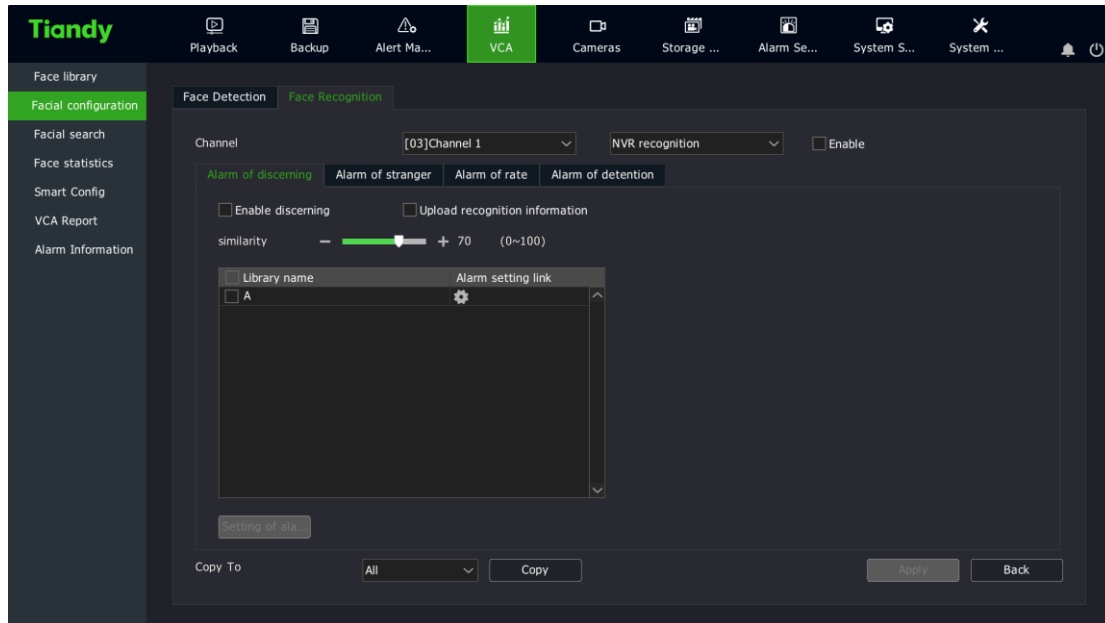

2. Select the algorithm type for face recognition, and choose to enable IPC Recognition/NVR recognition.

For IPC recognition, the front end is connected to the recognition camera, which is used to identify and compare the captured face, while NVR recognition refers to the recognition and comparison of the captured face.

3. Stay alarm. Select the "Stay Alarm" tab to set the parameters of stay alarm.

(1) Enable stay. Enable/disable the stay alarm function of the current channel.

(2) Upload identification info. Enable/disable the upload identification info function.

(3) Similarity. Set the similarity. The larger the value is, the more similar it will be.

(4) Stay time. Set the range of stay time from 1 to 99, in minutes and seconds.

(5) When the white library is checked, the stay alarm will not be triggered.

(6) Click Linkage Setting to set the arming linkage parameters of the stay alarm.



**Note:**

- When IPC detection is selected for the channel, up to 16 channels for NVR recognition are supported; When NVR detection is selected for the channel, up to 8 channels for NVR recognition are supported. The maximum number of supported channels is subject to the real product.

#### 4.14.8 Face Retrieval

1. Enter the "Main Menu -> VCA -> Face search", and select the "Retrieve by event" tab, as shown in the figure below.

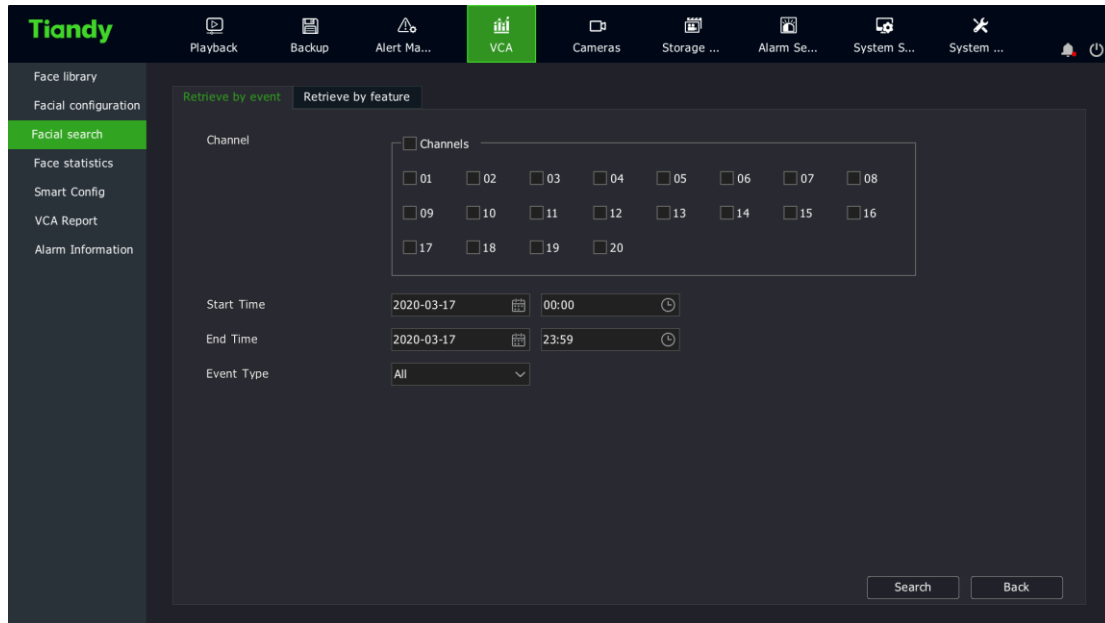

"Retrieve by Event": Users can choose the corresponding channel, and set the statistical type for the channel (options include all, face detection, comparison alarm, stranger alarm, frequency alarm, and stay alarm) to retrieve the corresponding type of data. The retrieved data is a snapshot picture of a face. Double-click the corresponding photo to see a large background image.

2. Enter the "Main Menu -> VCA -> Face search", and select the "Retrieve by Picture" tab, as shown in the figure below.

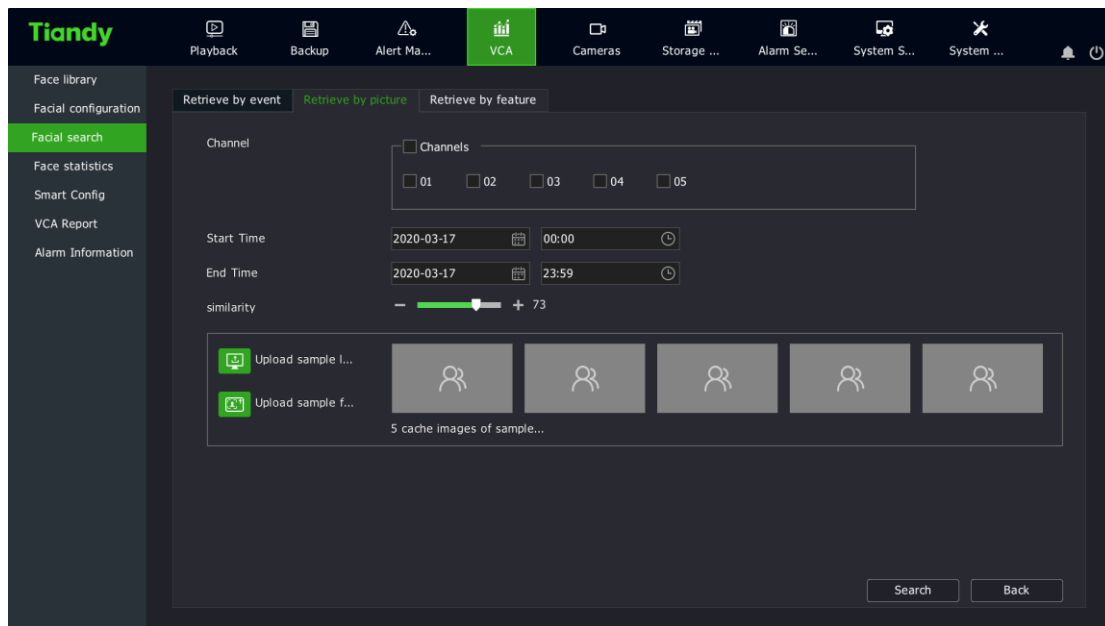

"Retrieve by Picture": Users can select the corresponding channel, and set the channel number, similarity and sample picture, and then clicks the "Retrieve" button to filter out alarm pictures of the corresponding similarity from all the alarm pictures.

3. Enter the "Main Menu ->VCA -> Face Search", and select the "Retrieve by Feature" tab, as shown in the figure below.

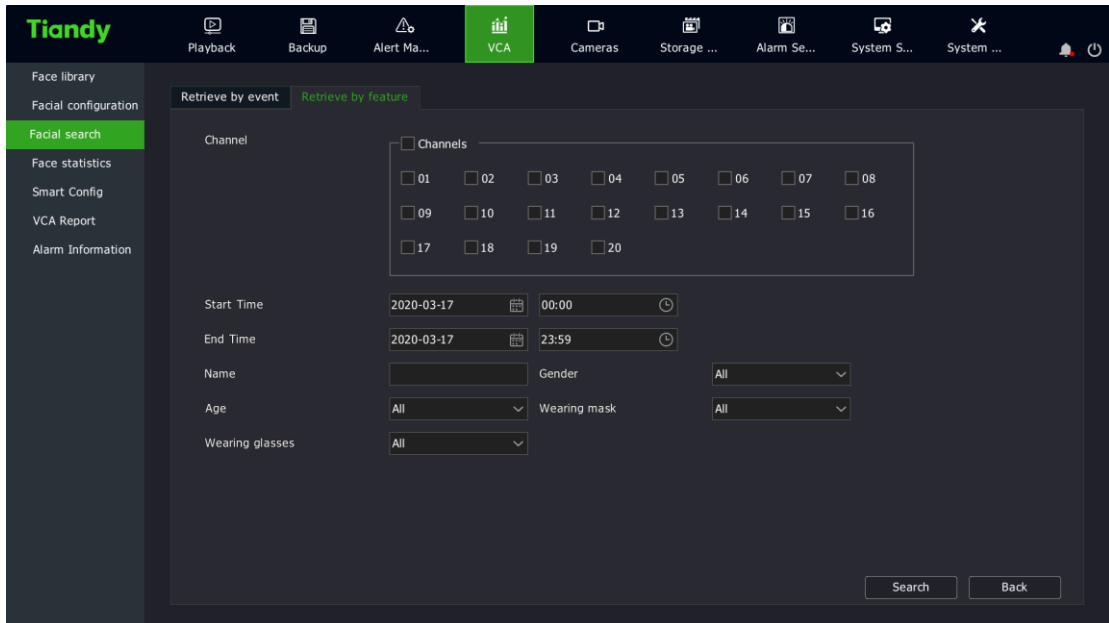

"Retrieve by Feature": Users can select the corresponding channel, set the channel name, gender, age, glasses and mask, and click the "Retrieve" button to filter out the alarm pictures of the corresponding features from all the alarm pictures.

#### 4.14.9 Face Statistics

1. Enter the "Main Menu -> VCA -> Face Statistics", and select the "Feature Statistics" tab. On the "Feature Statistics" interface, select the channel number, report type, and statistic type, and click the "Statistics" button to conduct face data statistics. The data displayed may be different, depending on statistic methods: Age, gender, glasses and mask are displayed in a list or pie graph, and the number of people is displayed in a list, bar graph or line graph. Select the statistics time and



click "Export" to export the corresponding report, as shown in the figure below:

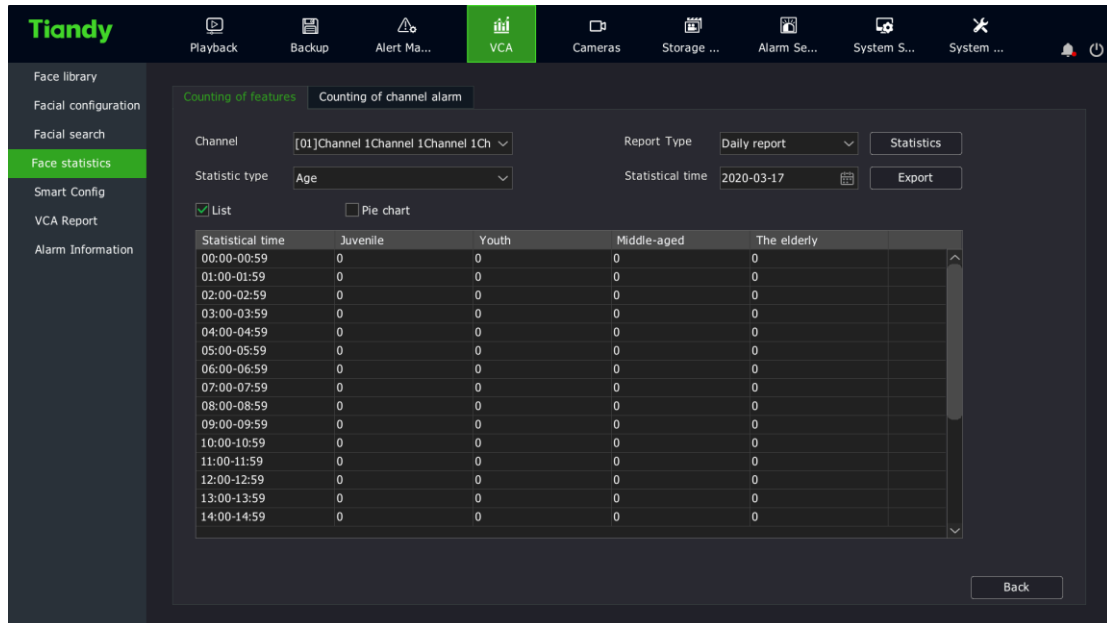

2. Select the "Counting of Target Alarm " tab. The target alarm statistics can include the alarm count of the corresponding library within the time period. Select the target library, report type, statistics time, and click "Statistics" to view the data. Click "Export" to export the corresponding report, as shown in the figure below:

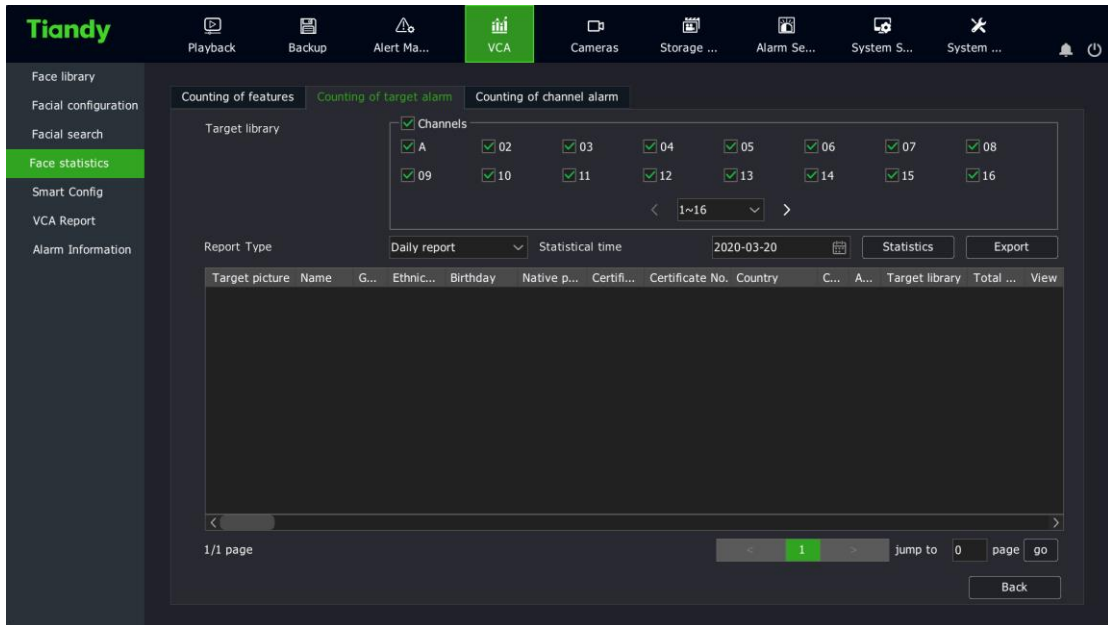

3. Select the " Counting of Channel Alarm" tab. Channel alarm statistics include the alarm count of the corresponding channel within the time period. Select channel, event type, report type, and statistics time, and click "Statistics" to view the data. Click "Export" to export the corresponding report, as shown in the figure below:

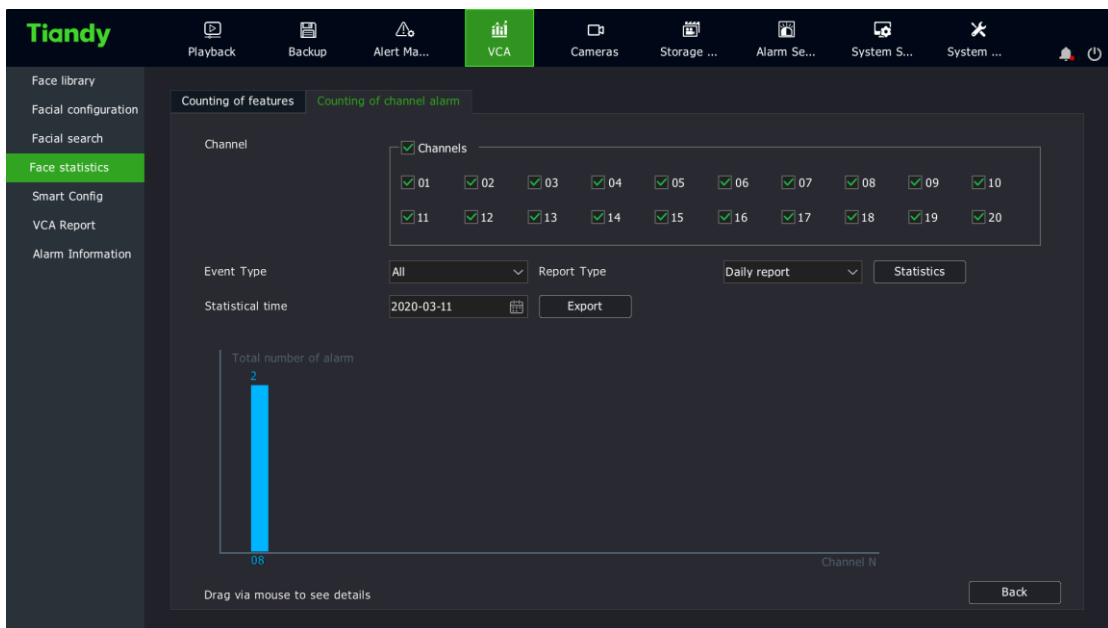

#### 4.14.10 Alarm Information

1. Enter the "Main Menu -> VCA -> Alarm Information" interface to display the real-time alarm information, as shown in the figure below.

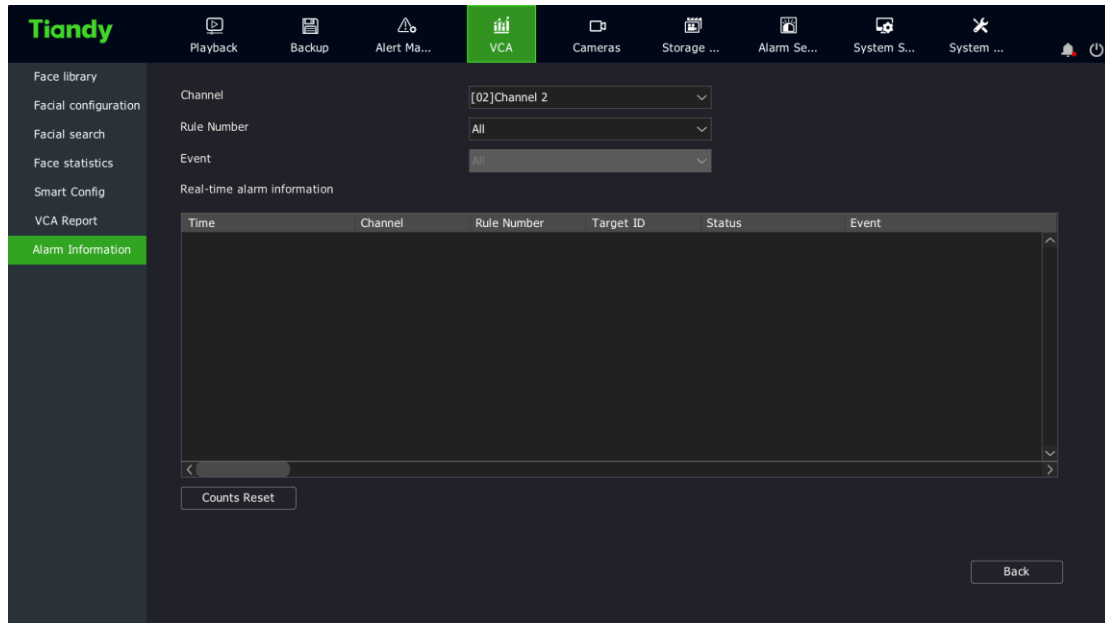

The real-time alarm information of the selected channel can be viewed on this interface.

2. Click the "Counts Reset" to clear the alarm information of the front end

#### 4.15. Mobile Monitoring

Users can download the mobile client by scanning the QR code and input the user ID for mobile monitoring.

- 1、 Right-click the mouse button to enter the right-click menu, and select "Mobile Monitoring" to enter the mobile monitoring interface, as shown in the figure below.

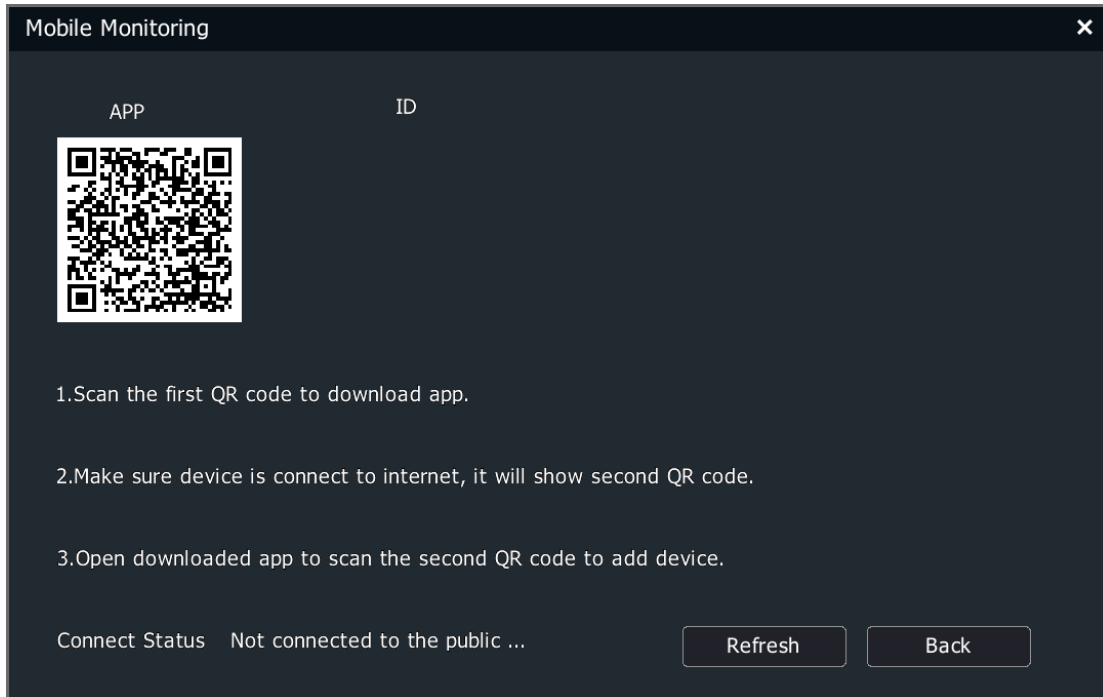

- 2、 Users scan the first "Mobile APP" to download the client, then scan the QR code at the "Device ID", and operate according to instructions to conduct video preview and control in the mobile phone.

## 5. Internet Keyboard

### 5.1 Keyboard Installation

1. Select the communication port. To control embedded DVRs, Ethernet port shall be used.

2. Power cable and control cable pass through under the bottom shell and are connected to the correct positions. Install the rubber strip.

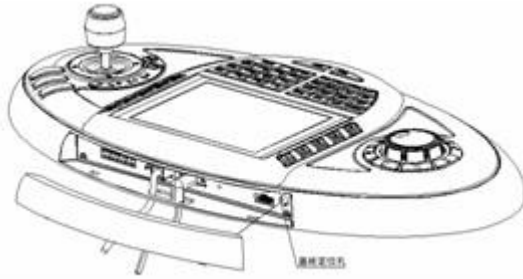

## 5.2 Description of Keys

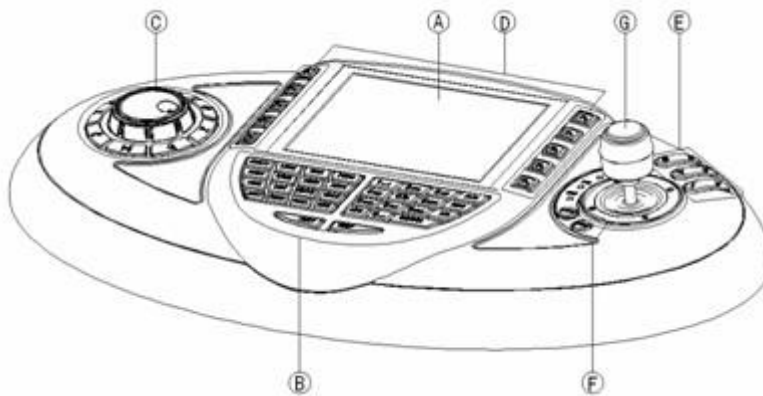

### A LCD Display:

Blue backlit, optional Chinese/English UI, real-time display of device status/programming information.

### B Main Key Area:

Green backlit.

Key "1": 1/symbol

Key "2": 2/A/B/C

Key "3": 3/D/E/F

Key "4": 4/G/H/I

Key "5": 5/J/K/L

Key "6": 6/M/N/O

Key "7": 7/P/Q/R/S

Key "8": 8/T/U/V

Key "9": 9/W/X/Y/Z

Key "0": number 0 or space

ESC: Deletes a character before the cursor

ENTER: Confirmation of menu/various setting interfaces

ACK: Manually clears all alarm outputs

PREV: On the synch playback full screen interface, press F2 to enter the full screen and press this key to enable digital zoom.

NEXT: On multi-screen sync playback full screen, press F2 to enter the full screen and press this key to enable the full single screen.

## C DVR Control Key Area:



Blue backlit. The functions of each key for controlling embedded DVRs are as follows:

1. Stop playing video files
2. Enter the manual video setting interface
3. Playback: Multi-screen full screen synch playback red box is switched to the previous small screen
4. Enter the video preview setting interface
5. In playback mode, control the playback and pause of video files
6. Single frame step. Play one frame for each press when playing back video files
7. Playback: Multi-screen full screen synch playback red box is switched to the next small screen

8. Switch to the playback screen.

9. Shuttle knob:

Clockwise rotation of the inner ring of the shuttle: Increases preview/playback volume

Anti-clockwise rotation of the inner ring of the shuttle: Reduces preview/playback volume

Clockwise rotation of the outer ring of the shuttle: Fast forward of video playback

Anticlockwise rotation of the outer ring of the shuttle: Fast reverse of video playback

CAM: Recording starts

MON: Recording stops

ALM: Snapshot

#### **D Extended Function Key Area:**

Yellow backlit. The functions of each key for controlling embedded DVRs are as follows:

Key F1: Switch to the Main Menu



Key F2: Switch to the PTZ control status or enter the full screen from non-full screen

Key F5: Exit and return to the previous menu or exit full screen during playback

Key F3: Switch the input method between number/pinyin/lowercase English letter/uppercase English letter

Key F4: Switch to logoff menu

Key F6: Intercom (reserved)

Key F7: Reserved

Key F8: call out the system info display interface

### E Camera Control Key Area:

Blue backlit. Used to control the action of the camera in PTZ control mode.

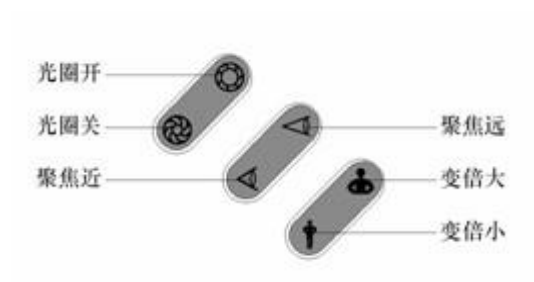

On the digital zoom interface, the Aperture ON/OFF button can be used to zoom in/out the digital zooming area

## **F Control Device Type Selection and Matrix Override Control Key Area:**

Button backlight is supported.

[MODE]: Control device selection, To control embedded NVRs, DVR shall be selected.

[PRI]: Reserved.

## **G 3D Vector Shift Rocker**

Rocker up, down, left and right actions realize the functions, including:

Up: In the control menu, used to select the previous item

In PTZ control mode, control the PTZ to move up

In video preview mode, used to select the previous channel

Down: In the control menu, used to select the next item

In PTZ control mode, control the PTZ to move down

In video preview mode, used to select the next channel

Left: In the control menu, used to select the previous item

In the PTZ control mode, control the PTZ to move left

In video preview mode, used to page up

Right: In the control menu, used to select the next item

In the PTZ control mode, control the PTZ to move right

In video preview mode, used to page down

## Appendix 1 Reference for HDD Capacity Calculation

Calculate the total capacity required a hard disk video recorder according to the video recording requirements (video type, video storage time).

Calculation method:

1. According to Equation (1), calculate the storage capacity  $q_i$  required by a single channel per hour, in MByte.

$$q_i = d_i \div 8 \times 3600 \div 1024 \quad (1)$$

Wherein:  $d_i$  - bit rate, in Kbit/s

2. After determining the recording time requirement, calculate the storage capacity  $m_i$  required by a single channel according to Equation (2), in MByte.

$$m_i = q_i \times h_i \times D_i \quad (2)$$

Wherein:  $h_i$  - recording time per day (hours)

$D_i$  - the number of days the video needs to be stored

3. According to Equation (3), calculate the total capacity  $q_T$  (total) required for timer recording of all channels of a hard disk video recorder.

$$q_T = \sum_{i=1}^c m_i \quad (3)$$

Wherein:  $c$  - the total number of channels for a DVR.

4. According to Equation (4), calculate the total capacity  $q_T$  (total) required alarm recording (including motion detection) for all channels of a hard disk video recorder.

$$q_T = \sum_{i=1}^c m_i \times a\% \quad (4)$$

Wherein:  $a\%$  - alarm incidence.

## Appendix 2 Troubleshooting of Common Faults

The fault phenomenon	Possible reasons for
After the 220V power supply is connected and the power switch is turned on, the "PWR" indicator on the panel (for 2U chassis, it is "Ready") is not on, and the fan is not running.	1) The power cable is damaged 2) The power switch is faulty

<p>After the 220V power supply is connected and the power switch is turned on, the "PWR" indicator on the panel (for 2U chassis, it is "Ready") is on in green, but the fan is not running.</p>	<ol style="list-style-type: none"> <li>1) The panel power cable is damaged</li> <li>2) The fan is damaged</li> </ol>
<p>After the hard disk video recorder is turned on, the monitor connected to VOUT has no signal.</p>	<ol style="list-style-type: none"> <li>1) The video cable connected to the monitor is broken</li> <li>2) The interface board of the DVR is broken</li> <li>3) The mother board of the DVR is broken</li> </ol>
<p>The hard drive cannot be found on startup.</p>	<ol style="list-style-type: none"> <li>1) The hard disk cable is broken</li> <li>2) The hard disk power cable is not plugged in</li> <li>3) The hard disk is damaged</li> </ol>
<p>Recording is impossible</p>	<ol style="list-style-type: none"> <li>1) HDD is not mounted to the SATA port</li> <li>2) HDD not formatted</li> <li>3) The video template is not</li> </ol>

	<p>enabled or the time period is not set correctly</p> <p>4) The index is currently being rebuilt</p> <p>5) The purpose of SATA is not set to recording</p>
<p>Video and audio network transmission fail in the client.</p>	<p>1) One or more of the items such as IP address, port number, user name, and password of the DVR entered in the "Local Config" on the client interface are incorrect</p> <p>2) The network cable is faulty</p> <p>3) The network interface of the mother board is broken</p>

## Appendix 3 Maintenance Instructions

1. Dust on the circuit board, if dampened, will cause short circuit, which will affect the normal operation of the equipment and even damage the equipment. To ensure the long-term and stable operation of the equipment, please regularly remove dust inside the cabinet.
2. Please ensure that the equipment is well grounded to avoid interference with video and audio signals and damage of equipment by static electricity or surge voltage.
3. Do not plug and unplug audio and video signal cables, RS-485, alarm interfaces under live conditions, which may easily damage the port.
4. Do not directly cut off the mains power to shut the equipment down, but to use the OFF button on the front panel (press and hold for more than 3 seconds) or on the video interface to allow the system to shut down automatically and then cut off the mains power to avoid damage to the hard disk.
5. Please keep the equipment away from heat sources and places.
6. Please maintain good ventilation around the equipment case for heat dissipation.
7. Please check and maintain the system regularly.

