

WL Panda for LightSYS



Model: RW432KPP

Installation and User Guide



For more information about RISCO Group's branches, distributors and full product line, please visit riscogroup.com

Language	Page
EN	3
IT	13
ES	23
FR	33
PR	43
NL	53

The 2-Way WL Panda for LightSYS keypad enables communication between the wireless keypad and a LightSYS control panel. Being bi-directional, the 2-Way keypad receives a reply status indication from the panel for each command sent to the panel. You can operate the keypad either using a code or a proximity tag.







Main Features

- Bi-directional Wireless Communication
- S.O.S / Two-way communication emergency key
- Proximity tag operation
- Double tamper protection (Box & Wall)
- Battery economy mode





Communication Setup

The WL Panda for LightSYS keypad must identify itself to the system receiver. This can be done by typing the 11-digit serial number of the keypad into the system or using RF mode.

Setup using RF communication

- From the Wired Keypad, navigate to the Programming (installer) menu, select **7)Install > 2)WL Device > 2)Allocation > 1)By RF > 3)Keypad** and then press 
- If there are two receivers allocated to the system, select the receiver you wish to allocate and then press 
- Select the Keypad location in the system and then press 
- On the WL Panda for LightSYS Keypad you wish to allocate, send a Write message by pressing both keys   simultaneously for at least 2 seconds; the keypad will display the Serial Number.
- On the Wired Keypad, press  to complete the allocation procedure

Setup by Serial Number

1. From the Wired Keypad, navigate to the Programming (installer) menu, select **7)Install**
> **2)WL Device** > **2)Allocation** > **2)By Code** > **3) Keypad** and then press 
2. If there are two receivers allocated to the system, select the receiver you wish to allocate and then press 
3. Select the Keypad location in the system and then press 
4. Enter the Keypad's 11-digit Serial Number and then press  ; the keypad will display the Serial Number.

NOTES:

1. Adding the keypad to the system can also be done remotely using the configuration software by entering the serial number of the keypad or by RF communication.
2. Downloading labels is performed by pressing the  key for 2 seconds. The panel will then send an update to the keypad.

Mounting the Keypad

Mount the keypad on the wall using the supplied mounting bracket.

NOTE: Before mounting the keypad test the keypad communication with the system.



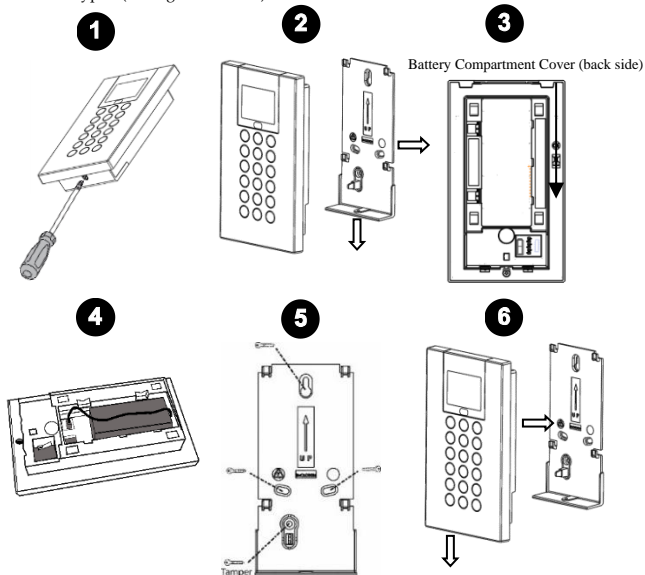



1. Remove the fastening screw that secures the mounting bracket to the keypad (see Figure 1).
2. Separate the mounting bracket from the keypad (see Figure 2).
3. Release battery cover from the keypad's battery compartment (see Figure 3).
4. Attach the battery cable to the battery connector (see Figure 4), insert the batteries (while paying attention to the polarity of the batteries) and close the battery compartment.
5. Allocate the Keypad to the Receiver (see Communication Setup).
6. Using the mounting holes as a template secure the mounting bracket to the wall (see Figure 5).
7. Mount the keypad to the mounting bracket and insert the fastening screw to lock the keypad (see Figures 6 and 1).



Main Keypad Operations

Visual Indicators







The following visual indicators are displayed on the LCD Keypad:

Icon	Indication	Operation
 Trouble	On	System trouble
	Off	System is operating normally
	On	System is ready to be armed
	Off	System is not ready to be armed
	Slow Flash	System is ready to be armed while exit/entry zone is open
 Arm / Alarm	On	System is armed in Full Arm or Stay Arm mode
	Off	System is disarmed
	Slow Flash	System is in Exit Delay
	Rapid Flash	Alarm condition
 Stay / Bypass	On	System is Stay Arm mode (Part Set) or Zone Bypass mode
	Off	No bypass zones in the system
 Tamper	On	Zone/keypad/external module has been tampered
	Off	All zones are operating normally
 Cloud Connectivity	On	System connected to cloud
	Slow Flash	Cloud connectivity trouble
	Off	No cloud connection configured / No cloud connectivity



User Operations





























Control Keys





The following lists details the user operations from the 2-Way WL Panda for LightSYS keypad.

Key	Operation
	In Normal Operation mode: Used for Away (Full setting).
	In User Functions menu: Used to change data.
	In Normal Operation mode: Used for Stay arming (Part Setting).
	In User Functions menu: Used to change data.
	Used to disarm (unset) the system after a user code is entered;  is used to terminate commands and confirm data to be stored.
	Used to scroll up a list or to move the cursor to the left; ⓘ Provides the system status.
	Used to scroll down a list or to move the cursor to the right.
	In Normal Operation mode: Used to enter the User Functions menu.
	In User Functions menu: Used to move back one step in the menu.

Common User Operations



Key	Operation
Away (Full Setting)	Code > 
Stay (Part Settings)	Code > 
Disarm (Unset) and Silence an alarm	Code > 

Key	Operation
Away (Full Setting) partition 1/2/3/4	Code >  > 1/2/3/4 > 
Stay (Part Settings) partition 1/2/3/4	Code >  > 1/2/3/4 > 
Partition Disarm (Unset)	Code >  > 1/2/3/4 > 
Duress Unset	Duress Code > 
Quick Zones Bypass (Omit)	Code >  [Zone No.]
Activate Output	 ← [Code]  [Activities]  [Output] Control]  [Prgrm Output Num]
Define Follow-Me	 ← [Code]  [Follow Me]  [Define]
View Fault	 ← [Code]  [View]  [Fault]
View Event Log	 ← [Code]  [Event Log] 
Keypad Chime On/Off	 ← [Code]  [Activities]  [Keypad sound]  [Chime]
Edit User Code	 ← [Code]  [Codes/Tags]  [Define]

Key	Operation
Changing Keypad Language	   simultaneously for 2 seconds > select  language >

Emergency Keys

The following operations will send emergency notifications to the alarm monitoring station

Key	Operation
4 + 6	Pressing both keys simultaneously for at least two seconds activates a Fire alarm
7 + 9	Pressing both keys simultaneously for at least two seconds activates an Emergency alarm
  	Pressing both keys simultaneously for at least two seconds activates a Police (Panic) alarm

Function Keys

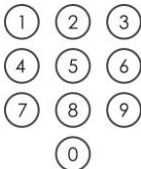
Key	Operation
1/2/3/5	Used to arm (set) groups of zones (by default) or to activate a prerecorded series of commands (macros). To activate press for 2 seconds NOTE: If both group arming and macros are defined in the panel, upon button press only macros will operate.
	Numerical keys that are used to input numeric codes (arming, disarming or used to activate specific functions)



Keypad Settings

Note: The following settings must be defined individually for each keypad connected to the system.

➤ To define keypad settings when idle follow this procedure:

1. Press  for two seconds until the Keypad Settings menu appears

2. Select the relevant icon using the  keys:

	Brightness
	Contrast
	Keypad's buzzer volume

3. Press 

4. Press the  keys to adjust the level settings.

5. Press  to save the adjustment.

6. Press  to exit the keypad settings.

Proximity Tag Operation

Present the Proximity Tag to the keypad (after waking the keypad) as shown in the following illustrations:

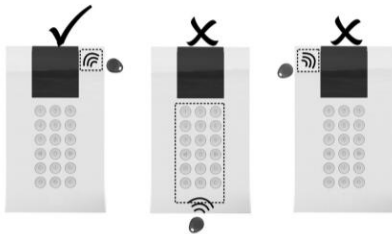

Figure 8

Sleep Mode

For extending the battery life of the keypad, the keypad is designed with a Sleep mode function. By default, 10 seconds after the last key has been pressed, the keypad will turn off its display and LEDs.

Replacing Batteries

1. Remove the fastening screw that secures the mounting bracket to the keypad (see Figure 1).
2. Slide the keypad and remove it from the mounting bracket.
3. Remove the battery compartment cover.
4. Disconnect the battery cable from the battery connector.
5. Replace the batteries while paying attention to the polarity of the batteries (see Figure 9).

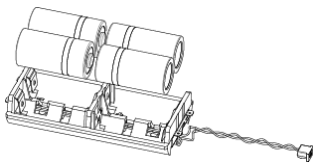



Figure 9

6. Reconnect the battery cable to the battery connector.
7. Close the battery compartment cover, place the keypad back on the wall and secure the screw to its place.

CAUTION: Risk of explosion if battery is replaced by an incorrect type. Dispose of used batteries according to local regulations.

Changing keypad parameters

Any change performed in the definition of the keypad parameters also requires

updating the keypad. This is performed by pressing the  key for 2 seconds. The panel will then send an update to the keypad.

Technical Specification

Electrical	
Battery Type	CR123, 3V Lithium battery (x 4)
Current Consumption	Standby current 9 μ A, Max current 150 mA
Power Output	868.65MHz: 10 mW
Frequency	433.92, 868.65, 915 MHz
Modulation Type	OOK
Typical Battery Life	3 years
Low battery indication	2.6 V
Proximity RF frequency	13.56 MHz
Physical	
Dimension (HxWxD)	180 x 115 x 35 mm (7.1 x 4.5 x 1.4")
Weight (Including batteries)	0.435 kg
Environmental	
Operating temperature	-10°C to 55°C (14°F to 131°F)
Storage temperature	-20°C to 60°C (-4°F to 140°F)
Humidity Range	Average relative humidity: 75%
Standard Compliance	EN 50131-1, EN 50131-3 Grade 2, Environmental Class II, EN 50131-6 Type C, EN 50131-5-3, PD6662:2017
Certification body	Applica Test & Certification

Ordering Information

Model	Description
RW432KPP400A	WL Panda for LightSYS Keypad Prox, 433
RW432KPP800A	WL Panda for LightSYS Keypad Prox, 868

Standard Compliance

RED Compliance Statement:

Hereby, RISCO Group declares that this equipment is in compliance with the essential requirements and other relevant provisions of Directive 2014/53/EU. For the CE Declaration of Conformity please refer to our website: www.riscogroup.com.

Introduzione

La tastiera radio bidirezionale Panda permette di comunicare con la centrale LightSYS in modalità bidirezionale evidenziando gli stati del sistema e le conferme per ogni comando trasmesso. La tastiera permette l'utilizzo tramite codice utente oppure Tag di prossimità.

Caratteristiche principali

- Comunicazione radio bidirezionale
- S.O.S. / Tasti di emergenza
- Tag di prossimità
- Protezione antimanomissione (Apertura e rimozione)
- Modalità risparmio batterie

Memorizzazione della Tastiera

La tastiera radio Panda per LightSYS deve essere identificata dalla ricevente del sistema tramite l'inserimento del numero di serie di 11 cifre o tramite procedura di auto-apprendimento via radio.

Memorizzazione per auto-apprendimento via radio

1. Tramite tastiera cablata del Sistema, accedere al menu di programmazione tecnica e selezionare **7)Configurazione > 2)Accessori Radio > 2)Memorizza > 1)Via Radio >**

3)Tastiere e premere



2. Se ci sono due ricevitori radio configurati nel Sistema, selezionare il ricevitore in

cui si vuole memorizzare la tastiera e premere



3. Selezionare il numero della tastiera e premere



4. Andare alla tastiera Radio Panda che si vuole memorizzare e trasmettere un messaggio



WRITE premendo simultaneamente i tasti per almeno 2 secondi. La tastiera visualizzerà sul suo display il proprio numero di serie.

Memorizzazione tramite Numero di Serie

1. Tramite tastiera cablata del Sistema, accedere al menu di programmazione tecnica e selezionare 7)Configurazione > 2)Accessori Radio > 2)Memorizza > 2)Via Nr. Di

Serie > 3)Tastiere e premere



2. Se ci sono due ricevitori radio configurati nel Sistema, selezionare il ricevitore in

cui si vuole memorizzare la tastiera e premere



3. Selezionare il numero della tastiera e premere



4. Digitare le 11 cifre del numero di serie della tastiera e premere  ; la tastiera visualizzerà il proprio numero di serie sul display.

NOTA:

1. La memorizzazione della tastiera può anche essere effettuata da remoto usando il software di configurazione CS inserendo il numero di serie della tastiera o predisponendo la centrale in auto-apprendimento per la memorizzazione radio.
2. Il download dei nomi viene effettuato premendo per almeno due secondi il tasto



Con questa procedura la centrale trasmetterà alla tastiera i parametri aggiornati.

Installazione della tastiera

Installare la tastiera a parete utilizzando la staffa.

NOTA: Prima di posizionare la tastiera verificare la comunicazione radio con la ricevente.



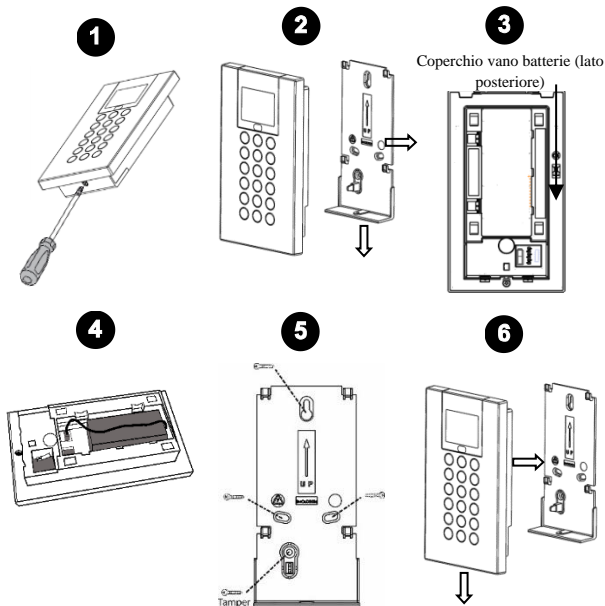



1. Rimuovere la vite che blocca la staffa alla tastiera (vedere Figura 1).
2. Sganciare la staffa dalla tastiera (vedere Figura 2).
3. Rimuovere il coperchio del vano batterie della tastiera (vedere Figura 3).
4. Inserire il cavo del vano batterie nel connettore (vedere Figura 4), inserire le batterie (fare attenzione alla polarità) e chiudere il coperchio.
5. Memorizzare la tastiera nel Ricevitore radio (vedere la procedura di Memorizzazione della tastiera).
6. Usare i fori di montaggio come dima e fissare la staffa alla parete (vedere Figura 5).
7. Fissare la tastiera sulla staffa e inserire la vite per bloccarla (vedere Figure 6 e 1).



Principali Comandi da Tastiera

Icone grafiche







Le icone grafiche che seguono vengono visualizzate sul display LCD della tastiera:

Icona	Stato	Significato
 Anomalia	On	Anomalia di sistema
	Off	Il sistema sta funzionando normalmente
	On	Il sistema è pronto per essere inserito
	Off	Il sistema non è pronto per essere inserito
	Lampeggio lento	Il Sistema è pronto per essere inserito anche se una zona Ingresso/Uscita è aperta
 Inserito / Allarme	On	Il sistema è inserito in Totale o Parziale
	Off	Il sistema è disinserito
	Lampeggio lento	Il sistema è in fase di ritardo in uscita per inserimento
	Lampeggio veloce	Allarme attivato
 Parziale / Esclusione	On	Il sistema è inserito in Parziale oppure ci sono delle zone escluse
	Off	Nessuna zona del sistema è esclusa
 Tamper	On	Manomissione di una zona/tastiera/modulo
	Off	Tutte le zone e i moduli stanno funzionando correttamente
 Connettività Cloud	On	Il sistema è connesso al Cloud
	Lampeggio lento	Anomalia di connessione al Cloud
	Off	Cloud non configurato o disconnesso



Operazioni Utente





























Tasti di Comando

La tabella che segue descrive le operazioni disponibili per l'utente tramite tastiera radio bidirezionale Panda del sistema LightSYS.

Tasto	Funzione/operazione
	Nel modo normale di funzionamento viene utilizzato per inserire il sistema in Totale. Nel menu Funzioni Utente viene usato per modificare dati.
	Nel modo normale di funzionamento viene utilizzato per inserire il sistema in Parziale. Nel menu funzioni utente viene usato per modificare dati.
	Usato per disinserire il Sistema dopo aver digitato il proprio codice utente;  è usato per terminare un comando e confermare i dati selezionati.
	Usato per scorrere in su una lista di dati o spostare il cursore a sinistra; ① Permette di visualizzare lo stato del sistema.
	Usato per scorrere in giù una lista di dati o spostare il cursore a destra.
	Nel modo normale di funzionamento viene utilizzato per accedere al menu delle Funzioni Utente. All'interno del menu Funzioni Utente serve per tornare al menu precedente.

Operazioni Utente più comuni

Tasto	Operazione
Inserimento Totale	Codice > 
Inserimento Parziale	Codice > 
Disinserimento e Tacitazione allarme	Codice > 

Tasto	Operazione
Inserimento Totale partizioni 1/2/3/4	Codice >  > 1 2 3 4 > 
Inserimento Parziale partizioni 1/2/3/4	Codice >  > 1 2 3 4 > 
Disinserimento partizioni	Codice >  > 1 2 3 4 > 
Disinserimento sotto coercizione	Codice coercizione > 
Esclusione veloce zone	Codice >  [Zona N.]
Attiva uscita	 ← [Codice]  [Attività]  [Attiva uscite]  [Selezionare l'uscita]
Impostazione numeri telefonici FM	 ← [Codice]  [Num. telefonici]  [Programmare/Modificare i numeri]
Visualizza i Guasti	 ← [Codice]  [Visualizza]  [Guasti]
Visualizza la memoria eventi	 ← [Codice]  [Memoria eventi] 
Chime tastiera On/Off	 ← [Codice]  [Attività]  [Toni tastiera]  [Chime]
Modifica Codici Utente/Tag	 ← [Codice]  [Codici/Tag]  [Imposta/Modifica i codici]

Tasto	Operazione
Modifica lingua tastiera	 Premere  simultaneamente per 2 secondi > selezionare la lingua >

Tasti di Emergenza

Le sequenze di tasti della tabella in basso permettono di segnalare eventi di emergenza.

Tasto	Funzione/Operazione
4 + 6	La pressione simultanea dei due tasti per due secondi attiverà una segnalazione antincendio
7 + 9	La pressione simultanea dei due tasti per due secondi attiverà una segnalazione di emergenza
	La pressione simultanea dei due tasti per due secondi attiverà una segnalazione di Rapina/Panico

Tasti Funzione

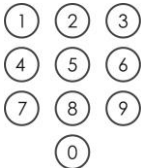
Tasto	Funzione/Operazione
1/2/3/5	<p>Usati per inserire gruppi di zone o, in alternativa, attivare delle macro (sequenze di comandi preimpostati).</p> <p>Per attivare la funzione premere il tasto per 2 secondi.</p> <p>NOTA: Se sullo stesso tasto viene definito sia il Gruppo di Inserimento che la funzione Macro, alla pressione del tasto funzionerà solo la Macro.</p>
	Tasti numerici utilizzati per inserire codici numerici per inserire, disinserire e attivare specifiche funzioni del sistema.



Impostazioni della Tastiera

Nota: le predisposizioni che seguono sono individuali per ogni singola tastiera configurata nel sistema.

➤ Per modificare le impostazioni della tastiera, procedere come segue:

1. Premere  per due secondi fino alla comparsa del menu seguente

2. Selezionare l'icona della funzione da modificare usando i tasti  :

	Luminosità
	Contrasto
	Volume cicalino interno tastiera

3. Premere 

4. Premere  per modificare i valori dell'opzione selezionata.

5. Premere  per memorizzare le modifiche.

6. Premere  per uscire dal menu di impostazioni della tastiera.

Funzionamento del Tag di prossimità

Avvicinare il tag alla tastiera come illustrato di seguito (dopo averla fatta uscire dalla modalità "Sleep" con la pressione di un qualsiasi tasto):



Figura 8

Modalità Sleep

Per prolungare la durata della batteria della tastiera, la tastiera è progettata con una funzione di modalità "Sleep". Per impostazione predefinita, 10 secondi dopo aver premuto l'ultimo tasto, la tastiera disattiva il display e i LED.

Sostituzione delle batterie

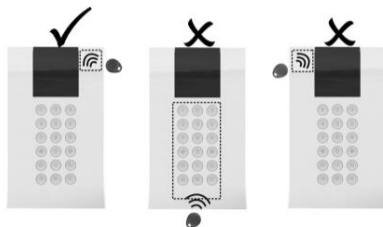
1. Rimuovere la vite di blocco della tastiera alla staffa di fissaggio (vedere Figura 1).
2. Rimuovere la tastiera dalla staffa.
3. Rimuovere il coperchio del vano batterie.
4. Scollegare il cavo batteria dall'apposito connettore.
5. Sostituire le batterie prestando attenzione alla polarità (vedere Figura 9).





Figura 9

6. Collegare nuovamente il cavo batteria al connettore.
7. Chiudere il vano batterie con il suo coperchio e riposizionare la tastiera nella sua staffa di fissaggio ricordandosi di inserire la vite di blocco.

ATTENZIONE: Rischio di esplosione se le batterie vengono sostituite con altre di tipologia non corretta. Smaltire le batterie usate in base alle normative locali.

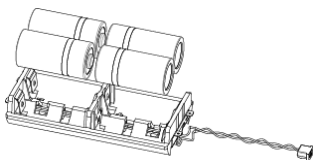
Modifica dei parametri della Tastiera

Ogni modifica effettuata nel sistema relativa ai parametri della tastiera richiede l'aggiornamento della programmazione della tastiera stessa. Questo aggiornamento

viene effettuato premendo per almeno due secondi il tasto  Con questa procedura la centrale trasmetterà alla tastiera i parametri aggiornati.

Specifiche Tecniche

Elettriche	
Tipo batterie	4 Batterie al litio 3 Volt, CR123,
Assorbimento in corrente	Assorbimento a riposo 9 μ A, Max. 150 mA
Potenza RF	868.65MHz: 10 mW
Frequenza RF	433.92, 868.65, 915 MHz
Tipo Modulazione	OOK
Durata tipica della batteria	3 anni
Soglia batteria scarica	2.6 V
Frequenza lettore di prox.	13.56 MHz
Fisiche	
Dimensioni (HxLxP)	180 x 115 x 35 mm (7.1 x 4.5 x 1.4")
Peso (Batterie incluse)	0.435 kg
Ambientali	
Temp. di funzionamento	Da -10°C a 55°C (da 14°F a 131°F)
Temperatura di stoccaggio	Da -20°C a 60°C (da -4°F a 140°F)
Umidità	Umidità relativa media: 75%
Certificazioni	EN 50131-1, EN 50131-3 Grado 2, Ambientale Classe II, EN 50131-6 Tipo C, EN 50131-5-3, PD6662:2017
Ente di certificazione	Applica Test & Certification

Informazioni per l'ordine

Modello	Descrizione
RW432KPP400A	Tastiera Radio Panda con Prossimità per LightSYS in 433 MHz
RW432KPP800A	Tastiera Radio Panda con Prossimità per LightSYS in 868 MHz

Conformità standard

Dichiarazione di Conformità RED:

La sottoscritta RISCO Group, dichiara sotto la propria responsabilità che questo prodotto è conforme ai requisiti essenziali e alle altre rilevanti disposizioni della Direttiva Europea 2014/53/EU.

Per le Dichiarazioni di Conformità CE, visitate il nostro sito web: www.riscogroup.com

Introducción

El teclado inalámbrico bidireccional Panda para LightSYS permite la comunicación entre el teclado inalámbrico y un panel de control de LightSYS. Al ser conexión bidireccional, el teclado recibe una indicación de estado de respuesta del panel para cada comando enviado. Puede utilizar el teclado con un código o con un llavero de proximidad.

Funciones principales

- Comunicación inalámbrica bidireccional
- S.O.S. / Tecla de emergencia
- Operación con Llavero de proximidad
- Doble protección de tamper (caja y pared)
- Modo de ahorro de batería

Configuración de la comunicación

El teclado inalámbrico Panda para LightSYS debe identificarse con el receptor del sistema. Esto se puede realizar introduciendo en el sistema el número de serie de 11 dígitos del teclado o usando el modo RF.

Configuración mediante comunicación RF

1. Desde el teclado con cable, vaya al menú Programación del Instalador, seleccione **7)Instalación > 2)Dispositivo Inalámbrico > 2)Asignación > 1)Por RF > 3)Teclado**

y presione 

2. Si hay dos receptores asignados al sistema, seleccione el receptor que desee

asignar y presione 

3. Seleccione la ubicación del teclado en el sistema y presione 

4. En el teclado inalámbrico Panda para LightSYS que quiera asignar, envíe un mensaje

de escritura presionando los dos botones   al mismo tiempo durante 2 segundos como mínimo; el teclado mostrará el número de serie.

5. En el teclado con cable, presione  para finalizar el procedimiento de asignación.

Configuración mediante número de serie

1. Desde el teclado con cable, vaya al menú Programación del Instalador, seleccione **7)Instalación > 2)Dispositivo Inalámbrico > 2)Asignación > 2)Por Código >**

3)Teclado y presione 



2. Si hay dos receptores asignados al sistema, seleccione el receptor que desee asignar y presione 

3. Seleccione la ubicación del teclado en el sistema y presione 

4. Introduzca el número de serie de 11 dígitos del teclado y presione  ; el teclado mostrará el número de serie.

NOTAS:

1. También puede añadir el teclado al sistema de forma remota mediante el software de configuración introduciendo el número de serie del teclado o a través de comunicación RF.

2. La descarga de nombres se lleva a cabo presionando la tecla   durante 2 segundos. El panel enviará entonces una actualización al teclado.

Montaje del teclado

Monte el teclado en la pared usando el soporte de montaje suministrado.

NOTA: antes de montar el teclado, pruebe la comunicación del teclado con el sistema.



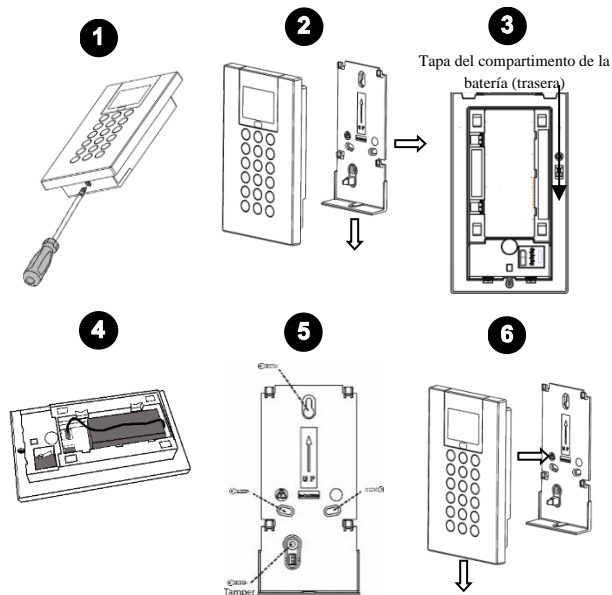



1. Quite el tornillo de fijación que une el soporte de montaje al teclado (ver Figura 1).
2. Separe el soporte de montaje del teclado (ver Figura 2).
3. Retire la tapa del compartimento de la batería del teclado (ver Figura 3).
4. Conecte el cable de la batería al conector de la batería (ver Figura 4), inserte las pilas (respetando la polaridad) y cierre el compartimento de la batería.
5. Asigne el teclado al receptor (ver Configuración de la comunicación).
6. Con los orificios de montaje como plantilla, fije el soporte de montaje a la pared (ver Figura 5).
7. Monte el teclado en el soporte de montaje e introduzca el tornillo de fijación para bloquear el teclado (ver Figuras 6 y 1).



Operaciones principales del teclado

Indicadores visuales







Los siguientes indicadores visuales se muestran en el teclado LCD:

Icono	Indicación	Operación
 Problema	Encendido	Problemas en el sistema
	Apagado	El sistema funciona con normalidad
	Encendido	El sistema está listo para el armado
	Apagado	El sistema no está listo para el armado
	Parpadeo lento	El sistema está listo para armado mientras la zona de salida/entrada está abierta
 Armado/Alarma	Encendido	El sistema está en modo Armado Total o Armado Parcial
	Apagado	El sistema está desarmado
	Parpadeo lento	El sistema está en Tiempo de Salida
	Parpadeo rápido	Situación de alarma
 Armado Parcial/Anulación	Encendido	El sistema está en modo Armado Parcial o en modo Anulación de Zona
	Apagado	No hay zonas anuladas en el sistema
 Tamper	Encendido	Se ha manipulado zonas/teclado/módulo externo
	Apagado	Todas las zonas funcionan con normalidad
 Conectividad con la Nube	Encendido	El sistema está conectado a la Nube
	Parpadeo lento	Problemas en la conectividad con la Nube
	Apagado	No hay configurada ninguna conexión con la Nube/No hay conectividad con la Nube



Operaciones del usuario



































Botones de control



La siguiente lista detalla las operaciones que el usuario puede llevar a cabo desde el teclado inalámbrico bidireccional Panda para LightSYS.

Botón	Operación
	En el modo Normal: se usa para Armar Total.
	En el menú de funciones de usuario: se usa para cambiar datos.
	En el modo Normal: se usa para Armado Parcial.
	En el menú de funciones de usuario: se usa para cambiar datos.
	Se usa para desarmar (anular) el sistema después de introducir un código de usuario;  se usa para finalizar comandos y confirmar los datos que se van a almacenar.
	Se usa para desplazarse hacia arriba en una lista o para mover el cursor hacia la izquierda; ⓘ proporciona el estado del sistema.
	Se usa para desplazarse hacia abajo en una lista o para mover el cursor hacia la derecha.
	En el modo Normal: se usa para acceder al menú de funciones de usuario.
	En el menú de funciones de usuario: se usa para retroceder un paso en el menú.

Operaciones comunes del usuario



Botón	Operación
Armado Total	Código > 
Armado Parcial	Código > 
Desarmado y Silenciar alarma	Código > 

Botón	Operación
Armado Total – Partición 1/2/3/4	Código >  > 1 2 3 4 > 
Armado Parcial – Partición 1/2/3/4	Código >  > 1 2 3 4 > 
Desarmado – Partición	Código >  > 1 2 3 4 > 
Desarmado – Coacción	Código Coacción > 
Anulación rápida de zona (omitir)	Código >  [N.º zona]
Activar una salida	  [Código]  [Actividades]  [Control Salidas]  [N.º Salida Prog.]
Definir número privado	  [Código]  [Número privado]  [Crear/modificar]
Ver fallo	  [Código]  [Visualizar]  [Problemas]
Ver registro de eventos	  [Código]  [Registro de Eventos] 
Timbre del teclado (act./desact.)	  [Código]  [Actividades]  [Sonido Teclado]  [Timbre]
Editar código de usuario	  [Código]  [Códigos/Llaves]  [Crear/Modificar]

Botón	Operación
Cambiar idioma del teclado	 a la vez durante 2 segundos >  seleccionar idioma >

Botones de emergencia

Las siguientes acciones enviarán notificaciones de emergencia a la central receptora de alarmas

Botón	Operación
4 + 6	Al presionar los dos botones a la vez durante al menos dos segundos, se activa la alarma de incendio
7 + 9	Al presionar los dos botones a la vez durante al menos dos segundos, se activa una alarma de emergencia
 + 	Al presionar los dos botones a la vez durante al menos dos segundos, se activa una alarma de policía (pánico)

Botones de función

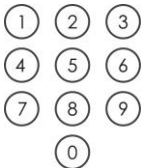

Botón	Operación
1 / 2 / 3 / 5	Se usa para armar (configurar) grupos de zonas (por defecto) o para activar una serie de comandos pregrabados (macros). Para activar, presionar durante 2 segundos NOTA: Si tanto el armado de grupo como las macros están definidas en el panel, al presionar el botón solo operarán las macros.
	Botones numéricos que se usan para introducir códigos numéricos (para armar, desarmar o activar funciones específicas)



Ajustes del teclado

Nota: es preciso definir los siguientes ajustes de forma individual en cada teclado conectado al sistema.

- Para definir los ajustes del teclado mientras está inactivo, seguir el procedimiento que se describe a continuación:

1. Presionar  durante dos segundos hasta que aparezca el menú Ajustes del teclado.

2. Seleccionar el icono correspondiente con los botones    :

	Brillo
	Contraste
	Volumen del zumbador del teclado

3. Presionar 

4. Presionar los botones    para ajustar los niveles.

5. Presionar  para guardar el ajuste.

6. Presionar  para salir del menú Ajustes del teclado.

Modo de llavero de proximidad

Acerque el llavero de proximidad al teclado (después de activar el teclado), tal como se muestra en las ilustraciones siguientes:



Figura 8

Modo de suspensión

Para ampliar la duración de la batería del teclado, éste está diseñado con una función de modo de suspensión. Por defecto, 10 segundos después de presionar la última tecla, el teclado apaga la pantalla y los LED.

Reemplazar las pilas

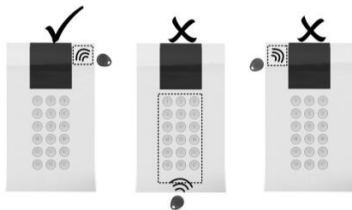
1. Quite el tornillo de fijación que une el soporte de montaje al teclado (ver Figura 1).
2. Deslice el teclado y extráigalo del soporte de montaje.
3. Quite la tapa del compartimento de la batería.
4. Desconecte el cable de la batería al conector de la batería.
5. Reemplace las pilas teniendo en cuenta su polaridad (ver Figura 9).



Figura 9

6. Vuelva a conectar el cable de la batería al conector de la batería.
7. Cierre la tapa del compartimento de la batería, vuelva a poner el teclado en la pared y fije el tornillo.

PRECAUCIÓN: Existe riesgo de explosión si las pilas se sustituyen por otras de tipo incorrecto. Deshágase de las pilas según la normativa local vigente.

Cambio de los parámetros del teclado

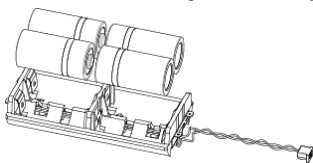
Cualquier cambio realizado en la definición de los parámetros del teclado también

requiere la actualización del teclado. Esto se lleva a cabo presionando la tecla durante 2 segundos. El panel enviará entonces una actualización al teclado.



Especificaciones técnicas

Datos eléctricos	
Tipo de batería	Pilas CR123 de litio de 3 V (x 4)
Consumo de corriente	Corriente en espera 9 μ A; Corriente máx. 150 mA
Salida de potencia	868,65 MHz: 10 mW
Frecuencia	433,92, 868,65, 915 MHz
Tipo de modulación	OOK
Duración típica de la batería	3 años
Indicación de batería baja	2,6 V
Frecuencia de RF de proximidad	13,56 MHz
Datos físicos	
Dimensiones (AL x AN x PR)	180 x 115 x 35 mm
Peso (pilas incluidas)	0,435 kg
Datos medioambientales	
Temperatura de funcionamiento	De -10°C a 55°C
Temperatura de almacenaje	De -20°C a 60°C
Rango de humedad	Humedad media relativa: 75%
Cumplimiento de normativas	EN 50131-1, EN 50131-3 Grado 2, Clase II Medioambiental, EN 50131-6 Tipo C, EN 50131-5-3, PD6662:2017
Organismo de certificación	Applca Test & Certification

Información para pedidos

Modelo	Descripción
RW432KPP400A	Teclado inalámbrico Panda con proximidad para LightSYS, 433
RW432KPP800A	Teclado inalámbrico Panda con proximidad para LightSYS, 868

Cumplimiento de normativas

Declaración de Conformidad RED :

Por la presente, RISCO Group declara que este equipo cumple con los requisitos esenciales y otras disposiciones relevantes de la Directiva 2014/53/EU. Para la Declaración de Conformidad CE, por favor diríjase a nuestra web: www.riscogroup.com.

Introduction

Le clavier Panda sans fil bidirectionnel pour LightSYS permet la communication entre le clavier sans fil et une centrale LightSYS. Grâce à sa technologie bidirectionnelle, le clavier reçoit en réponse une indication d'état de la centrale pour chaque commande envoyée. Vous pouvez utiliser le clavier soit avec un code soit avec un tag de proximité.

Caractéristiques principales

- Communication sans fil bidirectionnelle
- Touche d'urgence/d'appel
- Utilisation de tag de proximité
- Autoprotection à l'ouverture et à l'arrachement
- Mode d'économie de la batterie

Configuration de la communication

Le clavier Panda sans fil pour LightSYS doit être adressé dans la mémoire du récepteur du système. Vous pouvez pour cela saisir le numéro de série à 11 chiffres du clavier dans le système ou utiliser le mode RF.

Adressage par communication RF

1. Depuis le clavier filaire, accédez au menu Programmation (installateur), sélectionnez **7)Install > 2)Access. SF > 2)Allocation SF > 1)Par RF > 3)Clavier**, puis

appuyez sur 



2. Si deux récepteurs sont adressés sur le système, sélectionnez celui sur lequel vous

souhaitez adresser le clavier, puis appuyez sur 

3. Sélectionnez l'emplacement du clavier dans le système, puis appuyez sur







4. Sur le clavier Panda sans fil pour LightSYS que vous souhaitez adresser, envoyez un

message d'écriture en appuyant simultanément sur les touches   pendant au moins 2 secondes ; le numéro de série s'affiche sur le clavier.

5. Sur le clavier filaire, appuyez sur  pour terminer la procédure d'adressage.

Adressage par numéro de série

1. Depuis le clavier filaire, accédez au menu Programmation (installateur), sélectionnez **7)Install > 2)Access. SF > 2)Allocation SF > 2)Par N) Série >**
3)Clavier, puis appuyez sur 
2. Si deux récepteurs sont adressés sur le système, sélectionnez celui sur lequel vous souhaitez adresser le clavier, puis appuyez sur 
3. Sélectionnez l'emplacement du clavier dans le système, puis appuyez sur 
4. Saisissez le numéro de série à 11 chiffres du clavier, puis appuyez sur  ; le numéro de série s'affiche sur le clavier.

REMARQUES :

1. Vous pouvez également ajouter à distance le clavier au système via le logiciel de configuration CS en saisissant le numéro de série du clavier ou via la communication RF.
2. Pour télécharger des noms, appuyez sur la touche  ← pendant 2 secondes. La centrale envoie une mise à jour au clavier.

Fixation du clavier

Fixez le clavier au mur à l'aide du support de fixation fourni.

REMARQUE : avant d'installer le clavier, vérifiez qu'il communique correctement avec le système.



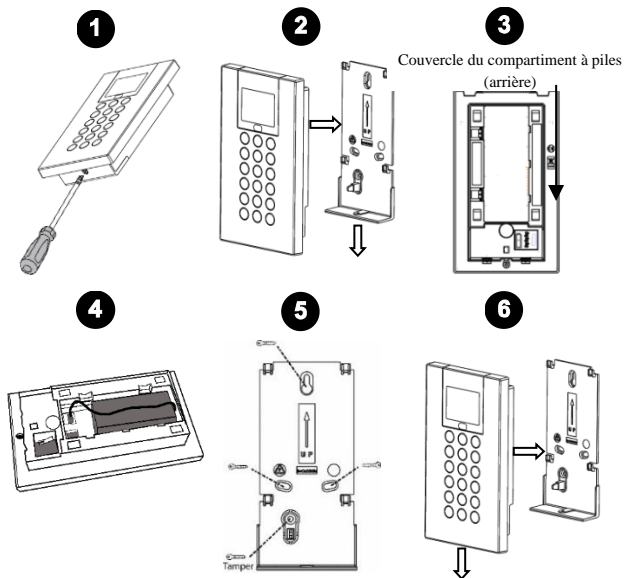



1. Retirez la vis qui fixe le support de fixation au clavier (voir Figure 1).
2. Séparez le support de fixation du clavier (voir Figure 2).
3. Ouvrez le couvercle du compartiment à piles du clavier (voir Figure 3).
4. Fixez le câble de batterie au connecteur de batterie (voir Figure 4), insérez les piles (en respectant les polarités), puis refermez le compartiment à piles.
5. Adressez le clavier au récepteur (reportez-vous à la section Configuration de la communication).
6. Utilisez les trous de fixation comme gabarits pour fixer le support de fixation au mur (voir Figure 5).
7. Installez le clavier sur le support de fixation et insérez la vis de fixation pour fixer le clavier (voir Figures 6 et 1).



Fonctions principales sur le clavier

Indicateurs visuels







Les indicateurs visuels suivants sont affichés sur le clavier LCD :

Icône	Indication	Opération
 Défaut	Allumé	Défaut système.
	Éteint	Le système fonctionne normalement.
	Allumé	Le système est prêt à être armé.
	Éteint	Le système n'est pas prêt à être armé.
	Clignotement lent	Le système est prêt à être armé et une zone type Entrée/Sortie est ouverte
 Armement / Alarme	Allumé	Le système est armé en mode Armé complètement ou Armé partiellement.
	Éteint	Le système est désarmé.
	Clignotement lent	Le système est en mode Temporisation de sortie.
	Clignotement rapide	Condition d'alarme.
 Partiel / Exclusion	Allumé	Le système est en mode Armé partiellement ou Exclusion de zone.
	Éteint	Il n'existe aucune zone exclue dans le système.
 Autoprotection	Allumé	Une zone, un clavier ou un module externe est en état d'autoprotection
	Éteint	Toutes les zones fonctionnent normalement.
 Connectivité au Cloud	Allumé	Le système est connecté au Cloud.
	Clignotement lent	Problème de connexion au Cloud.
	Éteint	Aucune connexion au Cloud configurée.



Fonctions utilisateur































Fonction des touches

Les listes suivantes détaillent les fonctions utilisateur sur le clavier sans fil bidirectionnel Panda pour LightSYS.

Touche	Opération
	En fonctionnement normal : utilisé pour Armer (mode complet).
	Dans le menu Fonctions utilisateur : utilisé pour modifier les données.
	En fonctionnement normal : utilisé pour Armer Partiellement.
	Dans le menu Fonctions utilisateur : utilisé pour modifier les données.
	Utilisé pour désarmer le système après la saisie du code utilisateur ;  permet aussi de valider les commandes et de confirmer les données à enregistrer.
	Utilisé pour faire défiler une liste vers le haut ou déplacer le curseur vers la gauche ; ⓘ indique l'état du système.
	Utilisé pour faire défiler une liste vers le bas ou déplacer le curseur vers la droite.
	En fonctionnement normal : utilisé pour accéder au menu de Fonctions Utilisateur.
	Dans le menu Fonctions utilisateur : utilisé pour revenir à l'étape précédente dans le menu.

Fonctions utilisateur communes

Fonction	Opération
Armement complet	Code > 
Armement partiel	Code > 
Désarmement et arrêt du son d'une alarme	Code > 

Fonction	Opération
Armement complet partition 1/2/3/4	Code >  > 1 2 3 4 > 
Armement partiel partition 1/2/3/4	Code >  > 1 2 3 4 > 
Désarmement par partition	Code >  > 1 2 3 4 > 
Désarmement sous contrainte	Code contrainte > 
Exclusion de zone rapide	Code >  [N° zone]
Activation de sortie	 ← [Code]  [Activités]  [Contrôle Sorties]  [Choix sortie programmable]
Définition Suivez-moi	 ← [Code]  [Suivez-moi]  [Définir]
Affichage des défauts	 ← [Code]  [Voir]  [Défaut]
Affichage du journal des événements	 ← [Code]  [Journal d'événements] 
Activation/désactivation carillon clavier	 ← [Code]  [Activités]  [Son clavier]  [Carillon]
Modification du code utilisateur	 ← [Code]  [Codes/Tags]  [Définir]
Modification de la langue du clavier	 ← 9 simultanément pendant 2 secondes > sélection de la langue > 

Touches d'urgence

Les procédures suivantes permettent d'envoyer des notifications d'urgence au centre de télésurveillance.

Touche	Opération
4 + 6	Appuyez simultanément sur ces deux touches pendant au moins deux secondes pour activer une alarme incendie.
7 + 9	Appuyez simultanément sur ces deux touches pendant au moins deux secondes pour activer une alarme d'urgence.
	Appuyez simultanément sur ces deux touches pendant au moins deux secondes pour activer une alarme panique.

Touches de fonction

Touche	Opération
1/2/3/5	Ces touches permettent d'armer des groupes de zones (par défaut) ou d'activer une série de commandes (macros) pré-enregistrées. Appuyez pendant deux secondes pour activer cette fonction. NOTE : Si l'armement par groupe et des macros sont définis dans la centrale, l'appui long sur les touches ne déclenchera que les macros associées.
	Les touches numériques permettent de saisir des codes numériques (armement, désarmement ou activation de fonctions spécifiques).



Configuration du clavier

Remarque : vous devez définir individuellement les paramètres suivants pour chaque clavier connecté au système.

➤ Pour configurer le clavier lorsqu'il est en veille, procédez comme suit :

1. Appuyez sur la touche  pendant deux secondes jusqu'à ce que le menu de Configuration du clavier s'affiche.



2. Sélectionnez l'icône correspondante à l'aide des touches    :

	Luminosité
	Contraste
	Volume du buzzer du clavier

3. Appuyez sur .

4. Appuyez sur les touches    pour régler les niveaux.

5. Appuyez sur la touche  pour enregistrer les valeurs définies.

6. Appuyez sur la touche   pour quitter la configuration du clavier.

Utilisation des tags de proximité

Présentez le tag de proximité au clavier (après avoir désactivé le mode veille sur ce dernier), comme le montrent les illustrations suivantes :

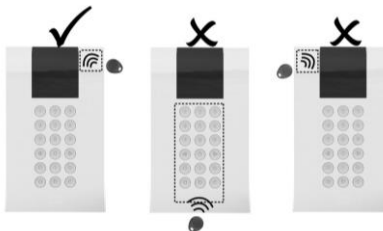

Figure 8

Mode veille

Pour prolonger l'autonomie des piles, le clavier est doté d'un mode veille. Par défaut, l'afficheur et les voyants du clavier s'éteignent 10 secondes après avoir appuyé sur la dernière touche.

Remplacement des piles

1. Retirez la vis qui fixe le support de fixation au clavier (voir Figure 1).
2. Faites glisser le clavier, puis retirez-le du support de fixation.
3. Retirez le couvercle du compartiment à piles.
4. Déconnectez le câble de batterie du connecteur de batterie.
5. Remplacez les piles en respectant les polarités (voir Figure 9).

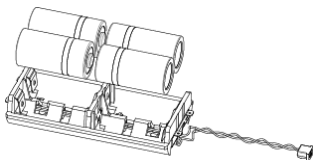



Figure 9

6. Reconnectez le câble de batterie au connecteur de batterie.
7. Fermez le couvercle du compartiment à piles, remplacez le clavier sur le support mural et fixez-le avec la vis.

ATTENTION : risque d'explosion si la pile est remplacée par un type de pile incorrect. La mise au rebut des piles usagées doit respecter les réglementations locales en vigueur.

Modification des paramètres du clavier

Chaque fois que vous modifiez la définition des paramètres du clavier, une mise à jour du clavier est nécessaire. Pour cela, appuyez sur la touche  pendant 2 secondes. La centrale envoie une mise à jour au clavier.

Caractéristiques techniques

Électriques	
Type de pile	Pile au lithium 3 V, CR123 (x4)
Consommation électrique	9 μ A en veille, 150 mA max.
Puissance de sortie	868,65 MHz : 10 mW
Fréquence	433,92 ; 868,65 ; 915 MHz
Type de modulation	OOK
Autonomie de la pile	3 ans (typique)
Indication batterie basse	2,6 V
Fréquences RF de proximité	13,56 MHz
Physiques	
Dimensions (HxLxP)	180 x 115 x 35 mm
Poids (piles incluses)	0,435 kg
Environnementales	
Température de fonctionnement	-10°C à 55°C
Température de stockage	-20°C à 60°C
Plage d'humidité	Humidité relative moyenne : 75 %
Conformité aux normes	EN 50131-1, EN 50131-3 Grade 2, Classe environnementale II, EN 50131-6 Type C, EN 50131-5-3, PD6662:2017
Organisme de certification	Applica Test & Certification

Informations de commande

Modèle	Description
RW432KPP400A	Clavier Panda sans fil avec proximité pour LightSYS, 433
RW432KPP800A	Clavier Panda sans fil avec proximité pour LightSYS, 868

Conformité aux normes

Rapport de Conformité de RED

Par la présente, RISCO Group, déclare que cet équipement est en conformité aux conditions essentielles et à d'autres dispositions appropriées de la directive 2014/53/EU. Vous pouvez trouver la copie complète de la déclaration de conformité à la directive 2014/53/EU sur notre site web, à l'adresse suivante :

www.riscogroup.com.

Introdução

O teclado bidirecional WL Panda para LightSYS permite a comunicação entre o teclado wireless e um painel de controlo LightSYS. Por ser bidirecional, o teclado recebe uma indicação de status de resposta do painel para cada comando enviado ao painel. Pode operar o teclado usando um código ou uma tag de proximidade.

Características principais

- Comunicação bidirecional wireless
- Chave de emergência/S.O.S
- Operação com tag de proximidade
- Dupla proteção antivolação (Box & Wall)
- Modo de economia de bateria

Configuração da comunicação

O teclado WL Panda para LightSYS deve identificar-se para o receptor do sistema. Isto pode ser feito digitando o número de série do teclado com 11 dígitos no sistema ou usando o modo de RF.

Configuração usando comunicação por RF

1. No teclado com fio, navegue até o menu Programming (programação) (do instalador), selecione **7) Install (instalar) > 2) WL Device (dispositivo sem fio) > 2) Allocation (atribuição) > 1) By RF (por RF) > 3) Keypad (teclado)** e, em

seguida, pressione



2. Se houver dois receptores atribuídos ao sistema, selecione o receptor que você

deseja atribuir e pressione



3. Selecione o local do teclado no sistema e pressione



4. No teclado WL Panda para LightSYS que você deseja atribuir, envie uma mensagem

de gravação pressionando as teclas







e



simultaneamente por pelo menos 2 segundos; o teclado mostrará o número de série.

5. No teclado com fio, pressione  para concluir o procedimento de alocação.

Configuração através do número de série

1. No teclado com fio, navegue até o menu Programming (programação) (do instalador), selecione **7) Install (instalar) > 2) WL Device (dispositivo sem fio) > 2) Allocation (atribuição) > 2) By Code (por código) > 3) Keypad (teclado)** e, em seguida, pressione .
2. Se houver dois receptores atribuídos ao sistema, selecione o receptor que você deseja atribuir e pressione .
3. Selecione o local do teclado no sistema e pressione .
4. Digite o número de série de 11 dígitos do teclado e pressione ; o teclado exibirá o número de série.

NOTAS:

1. A inclusão do teclado no sistema também pode ser feita remotamente com o software de configuração, inserindo o número de série do teclado ou por comunicação RF.
2. O download dos nomes é feito pressionando a tecla  por 2 segundos. O painel enviará então uma atualização para o teclado.

Instalação do teclado

Fixe o teclado na parede usando o suporte de Instalação fornecido.

NOTA: Antes de instalar o teclado, teste a sua comunicação com o sistema.



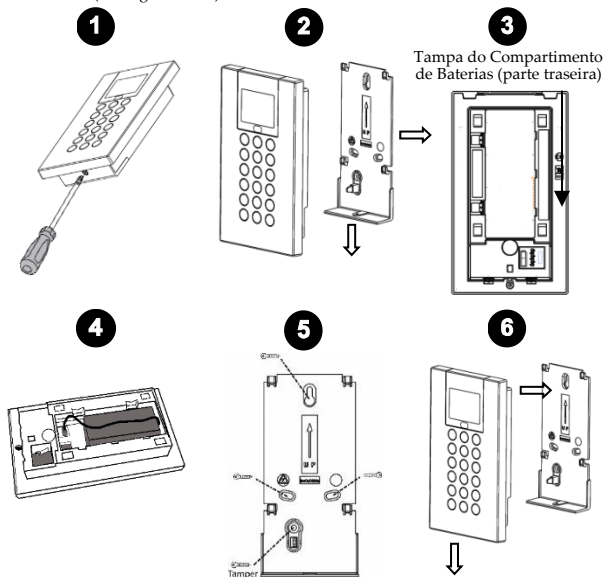



1. Remova o parafuso de fixação que prende o suporte de Instalação ao teclado (ver Figura 1).
2. Separe o suporte de Instalação do teclado (ver Figura 2).
3. Liberte a tampa do compartimento de baterias do teclado (ver Figura 3).
4. Fixe o cabo das baterias ao seu conector (ver Figura 4), insira as baterias (prestando atenção à polaridade das mesmas) e feche o compartimento de baterias.
5. Atribua o Teclado ao Receptor (consulte Configuração de Comunicação).
6. Usando os furos de Instalação como modelo, fixe o suporte de Instalação à parede (ver Figura 5).
7. Fixe o teclado no suporte de Instalação e insira o parafuso de fixação para travar o teclado (ver Figuras 6 e 1).



Operações principais do teclado

Indicadores visuais

Os indicadores visuais a seguir são exibidos no teclado LCD:







Ícone	Indicação	Operação
 Problema	Ligado	Problema no sistema
	Desligado	Sistema a operar normalmente
	Ligado	O sistema está pronto para ser armado
	Desligado	O sistema não está pronto para ser armado
	Piscando lentamente	O sistema está pronto para ser armado enquanto a zona de entrada/saída está aberta
 Armar/Alarme	Ligado	O sistema está armado em modo Full Arm (Arme Total) ou Stay Arm (Arme Parcial)
	Desligado	O sistema está desarmado.
	Piscando lentamente	O sistema está em modo de atraso de saída.
	Piscando rápido	Condição do alarme
 Ativação parcial/Bypass	Ligado	O sistema está no modo Stay Arm (Ativação Parcial) ou no modo Zone Bypass (Zonas com Bypass)
	Desligado	Nenhuma zona com bypass no sistema
 Botão antivolação	Ligado	Ocorreu violação de zona/teclado/módulo externo.
	Desligado	Todas as zonas estão a operar normalmente
 Conectividade na cloud	Ligado	Sistema conectado à cloud
	Piscando lentamente	Problema de conectividade da cloud
	Desligado	Nenhuma conexão com a cloud configurada/Não há conectividade com a cloud

Operações do usuário

Teclas de controlo

As listas a seguir detalham as operações do usuário para o teclado sem fio bidirecional Panda para LightSYS.



Teclas de controlo

Tecla	Operação
	Em modo de Operação Normal: Usado para o modo Away (ausência) (armado total). No menu User Functions (Funções do Usuário): Usado para modificar dados.
	Em modo de Operação Normal: Usado para o modo Stay (permanência) (armado parcial). No menu User Functions (Funções do Usuário): Usado para modificar dados.
	Usado para desarmar (desativar) o sistema após a inserção de uma senha do usuário.  é usado para finalizar comandos e confirmar os dados a serem armazenados.
	Usada para avançar para cima numa lista ou para mover o cursor para a esquerda; ⓘ Fornece o status do sistema.
	Usada para avançar para baixo numa lista ou para mover o cursor para a direita.
	Em modo de Operação Normal: Usadas para aceder ao menu User Functions (Funções do Usuário). No menu User Functions (Funções do Usuário): Usadas para retroceder um passo no menu.

Operações comuns do usuário

Tecla	Operação
Ausente (Ativação completa)	Código > 

Tecla	Operação
Presente (Ativação parcial)	Código >
Desarmar (Desativar) e silenciar um alarme	Código >
Ausente (Ativação completa) partição 1/2/3/4	Código > > 1 / 2 / 3 / 4 >
Presente (Ativação parcial) partição 1/2/3/4	Código > > 1 / 2 / 3 / 4 >
Desarmar partição (Desativar)	Código > > 1 / 2 / 3 / 4 >
Desativar coação	Código de coação >
Desvio rápido de zonas (omitir)	Código > [Nº da zona]
Ativar saída	← [Código] [Atividades] [controle de saída] [Núm. de saída do prog]
Definir Siga-me	← [Código] [Siga-me] [Definir]
Visualizar falha	← [Código] [Visualizar] [Falha]
Visualizar registo de eventos	← [Código] [Registo de eventos]
Ligar/desligar campainha do teclado	← [Código] [Atividades] [Som do teclado] [Campainha]
Editar código do usuário	← [Código] [Códigos/Tags] [Definir]

Tecla	Operação
Alterar idioma do teclado	 simultaneamente durante 2 segundos >  selecionar idioma >

Teclas de emergência

As operações a seguir enviarão notificações de emergência à central de monitorização de alarmes

Tecla	Operação
4 + 6	Pressionar as duas teclas simultaneamente pelo menos dois segundos ativa um alarme de incêndio.
7 + 9	Pressionar as duas teclas simultaneamente pelo menos dois segundos ativa um alarme de emergência
	Pressionar as duas teclas simultaneamente pelo menos dois segundos ativa um alarme de polícia (pânico)

Teclas de função

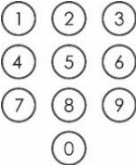

Tecla	Operação
1/2/3/5	<p>Usado para armar grupos de zonas (por padrão) ou para ativar uma série pré-gravada de comandos (macros). Para ativar pressione por 2 segundos</p> <p>NOTA: Se tanto o Armado de Grupos como as Macros forem definidos no painel, ao pressionar o botão, apenas as Macros irão funcionar.</p>
	As teclas numéricas que são usadas para inserir códigos numéricos (armar, desarmar, ou usados para ativar funções específicas)



Configurações do teclado

Nota: As configurações a seguir devem ser definidas individualmente para cada teclado conectado ao sistema.

- Para definir as configurações do teclado quando ocioso (não usado), siga o procedimento abaixo:

1. Pressione  durante dois segundos até aparecer o menu Keypad Settings (configurações do teclado)



2. Selecione o ícone desejado usando as teclas   e  :

	Brilho
	Contraste
	Volume da campainha do teclado

3. Pressione .

4. Pressione as teclas   e  para ajustar a configuração dos níveis.

5. Pressione  para salvar o ajuste.

6. Pressione   para sair das configurações do teclado.

Operação do Tag de Proximidade

Apresente a tag de proximidade ao teclado (após reativá-lo), como apresentado nas ilustrações abaixo:



Figura 8

Modo de repouso

Para prolongar a vida útil das baterias, o teclado foi elaborado com uma função de modo de repouso. Por padrão, a tela e os LEDs do teclado são desligados 10 segundos após a última tecla ser pressionada.

Substituição das baterias

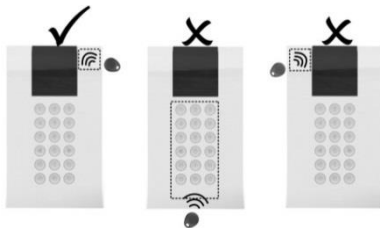
1. Remova o parafuso de fixação que prende o suporte de Instalação ao teclado (ver Figura 1).
2. Deslize o teclado e retire-o do suporte de Instalação.
3. Remova a tampa do compartimento de baterias.
4. Desconecte o cabo das baterias do seu conector.
5. Troque as baterias prestando atenção na sua polaridade (veja a Figura 9).





Figura 9

6. Reconecte o cabo das baterias ao seu conector.
7. Feche a tampa do compartimento de baterias, coloque o teclado de volta na parede e fixe o parafuso no seu lugar.

CUIDADO: Há RISCO de explosão caso a bateria seja substituída por uma incompatível. Descarte baterias usadas de acordo com regulamentos locais.

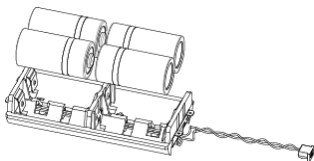
Alteração de parâmetros do teclado

Qualquer alteração executada na definição dos parâmetros do teclado também exige a

atualização do teclado. Isto é feito pressionando a tecla  por 2 segundos. O painel enviará então uma atualização para o teclado.

Especificações técnicas

Elétricas	
Tipo de bateria	Bateria (pilha) de lítio 3V, CR123 (x 4)
Consumo de corrente	Corrente de standby 9 μ A, Corrente máxima 150 mA
Potência de saída	868,65 MHz: 10 mW
Frequência	433,92; 868,65; 915 MHz
Tipo de Modulação	OOK
Vida útil típica das baterias	3 anos
Indicação de bateria fraca	2,6 V
Proximidade de frequência de RF	13,56 MHz
Físicas	
Tamanho (AxLxP)	180 x 115 x 35 mm (7,1 x 4,5 x 1,4 pol.)
Peso (incluindo baterias)	0,435 kg
Ambientais	
Temperatura de funcionamento	-10°C a 55 C (14°F a 131°F)
Temperatura de armazenamento	-20°C a 60 C (-4°F a 140°F)
Faixa de umidade	Húmidade relativa média: 75%
Conformidade com normas	EN 50131-1, EN 50131-3 Grau 2, Classe Ambiental II, EN 50131-6 Tipo C, EN 50131-5-3, PD6662:2017
Organismo de certificação	Applica Test & Certification

Informações sobre pedidos

Modelo	Descrição
RW432KPP400A	Teclado WL Panda com Função de Proximidade para LightSYS, 433
RW432KPP800A	Teclado WL Panda com Função de Proximidade para LightSYS, 868

Conformidade com normas

Declaração de conformidade RED:

Por meio deste, o RISCO Group declara que o seu equipamento está em conformidade com as necessidades essenciais e outras provisões relevantes da diretiva 2014/53/EU. Para ver a declaração de conformidade CE, por favor consulte o nosso website: www.riscogroup.com

Introductie

Het 2-Weg DL Panda bediendeel voor LightSYS laat de communicatie toe tussen een draadloze bediendeel en het LightSYS paneel. Door de bi-directionele functionaliteit is er voor elk commando dat verstuurd wordt naar het paneel een terugkoppeling met de status. U kan het bediendeel bedienen door middel van een code of proximity tag.

Hoofdkenmerken

- 2-Weg draadloze communicatie
- S.O.S / Twee-weg communicatie noodknop
- Proximity tag bediening
- Dubbele sabotage bescherming (Box & Muur)
- Batterij met besparingsmodus

Communicatie Setup

Het DL Panda bediendeel voor LightSYS dient zich te identificeren aan de ontvanger. Dit is mogelijk door het ingeven van het 11-cijferige serienummer of door gebruik te maken van de RF mode.

Aanleren door gebruik te maken van RF communicatie

1. Via het bedrade bediendeel dient u te navigeren naar het programmeer (installateur) menu, selecteer 7)Instellen > 2)DL Apparaat > 2)DL aanleren > 1)dmv RF >



3)Keypad en druk dan op 

2. Indien er 2 ontvangers aangeleerd zijn op het systeem, selecteert u de ontvanger

waar u het bediendeel wenst op aan te leren en druk op 

3. Selecteer de locatie van het bediendeel in het systeem en druk dan op 

4. Op het DL Panda bediendeel voor LightSYS dat u wenst aan te leren dient u een

schrijfboodschap te sturen door gelijktijdig de toetsen   gedurende ten minste 2 seconden in te drukken; Het bediendeel zal dan het serienummer weergeven.

5. Druk op het bedrade toetsenpaneel op  om de toewijzingsprocedure te voltooien.

Aanleren via serienummer

1. Via het bedrade bediendeel dient u te navigeren naar het programmeer (installateur) menu, selecteer 7)Instellen > 2)DL Apparaat > 2)DL aanleren > 2)dmv Code > 3)

Keypad en druk dan op 

2. Indien er 2 ontvangers aangeleerd zijn op het systeem, selecteert u de ontvanger

waar u het bediendeel wenst op aan te leren en druk op 

3. Selecteer de locatie van het bediendeel in het systeem en druk dan op 

4. Geef het 11-cijferige serienummer in en druk dan op  ; Het bediendeel zal dan het serienummer weergeven.

Opmerking:

1. Het toevoegen van een bediendeel kan ook uitgevoerd worden vanop afstand via de configuratie software door het ingeven van het serienummer van het bediendeel of door RF communicatie.

2. U kan namen downloaden door gedurende 2 sec op de toets  te drukken. Het paneel zal dan de update naar het bediendeel sturen.

Installeren van het bediendeel

Monteer het bediendeel op de muur door gebruik te maken van de meegeleverde montage beugel.

Opmerking: Alvorens het bediendeel te installeren dient u eerst de communicatie te testen met het systeem.



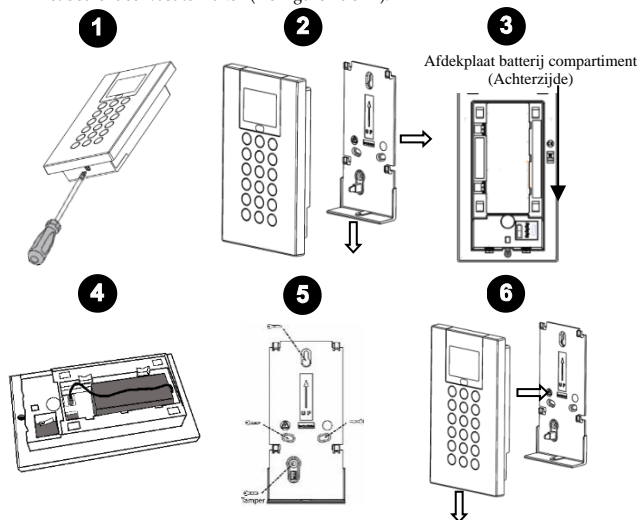



1. Verwijder de bevestigingsschroef welke de montage beugel vergrendelt aan het bediendeel (zie Figuur 1).
2. Koppel de montage beugel los van het bediendeel (zie Figuur 2).
3. Verwijder de batterij afdekplaat van het batterijcompartiment op het bediendeel (zie Figuur 3).
4. Verbind de batterijkabel met de connector (zie Figuur 4), plaats de batterijen (gelieve de polariteit van de batterijen in acht te nemen) en sluit het batterijcompartiment.
5. Koppel het bediendeel met de ontvanger (zie Communicatie Setup).
6. Gebruik de bevestigingsgaten als een sjabloon en bevestig de montagebeugel aan de muur (zie Figuur 5).
7. Monteer het bediendeel in de montagebeugel en plaats de bevestigingsschroef om het bediendeel vast te maken (zie Figuren 6 en 1).



Werking van het bediendeel

Visuele indicatoren







De volgende visuele indicatoren worden weergegeven op het LCD scherm:

Icoon	Indication	Beschrijving
 Fouten	Aan	Systeemfout
	Uit	Systeem functioneert normaal
	Aan	Systeem is klaar om ingeschakeld te worden
	Uit	Systeem is niet klaar om ingeschakeld te worden
	Traag knipperen	Systeem is klaar om ingeschakeld te worden terwijl de vertraagde zone open is
 Ingeschakeld / Alarm	Aan	Systeem is ingeschakeld in Volledig of Deels ingeschakeld mode
	Uit	Systeem is uitgeschakeld
	Traag knipperen	Systeem is in uitloopvertraging
	Snel knipperen	Alarm conditie
 Deels / Overbrug	Aan	Systeem is in Deels ingeschakeld mode of in zone overbrugging mode
	Uit	Geen overbrugging van zones in het systeem
 Sabotage	Aan	Zone/bediendeel/externe module heeft een sabotage
	Uit	All zones in normale toestand
 Cloud connectiviteit	Aan	Systeem verbonden met de RISCO Cloud
	Traag knipperen	RISCO Cloud connectie probleem
	Uit	Geen RISCO Cloud connectie geconfigureerd / Geen RISCO Cloud connectie



Bedieningstoetsen





























In de volgende lijst worden de gebruikershandelingen van de 2-weg WL Panda voor LightSYSYS-toetsenpaneel in detail beschreven.



Bedientoetsen

Toets	Beschrijving
	In normale mode: Wordt gebruikt om volledig in te schakelen.
	In het gebruikersmenu: Wordt gebruikt om data te veranderen.
	In normale mode: Wordt gebruikt om deels in te schakelen.
	Bij gebruiker functiemenu's: wordt gebruikt om instellingen te wijzigen.
	Wordt gebruikt om het systeem uit te schakelen na ingave van een geldige gebruikerscode;  wordt ook gebruikt om commando's te annuleren of om instellingen op te slaan.
	Wordt gebruikt om naar boven te scrollen in een lijst of om de cursor naar links te verschuiven; ⓘ Geeft de systeem status weer
	Wordt gebruikt om in een lijst naar beneden te scrollen of de cursor te verplaatsen naar rechts
	In normale mode: Wordt gebruikt om in het gebruikersmenu te gaan.
	In het gebruikersmenu: Wordt gebruikt om een stap terug te gaan in het menu.

Veelvoorkomende gebruikershandelingen



Toets	Werking
Afwezig (volledig inschakelen)	Code > 
Thuis (deels inschakelen)	Code > 
Uitschakelen en geluid van alarm uitzetten	Code > 

Toets	Werking
Afwezig (volledig inschakelen) partitie 1/2/3/4	Code >  > 1/2/3/4 > 
Thuis (deels inschakelen) partitie 1/2/3/4	Code >  > 1/2/3/4 > 
Partitie uitschakelen	Code >  > 1/2/3/4 > 
Dwang uitschakelen	Dwangcode > 
Snelle zoneoverbrugging (overslaan)	Code >  [Zonenummer]
Uitgang activeren	 ← [Code]  [Activiteiten]  [Uitgangscontrole]  [Nummer programma-uitgang]
Follow-me definiëren	 ← [Code]  [Follow Me]  [Definiëren]
Storing bekijken	 ← [Code]  [Bekijk]  [Storing]
Gebeurtenissenlog bekijk	 ← [Code]  [Gebeurtenissenlog] 
Toetsenpaneelgeluid aan/uit	 ← [Code]  [Activiteiten]  [Geluid toetsenpaneel]  [Geluid]
Gebruikerscode wijzigen	 ← [Code]  [Codes/Tags]  [Definiëren]

Toets	Werking
Taal toetsenpaneel wijzigen	 tegelijkertijd 2 seconden indrukken  > selecteer taal >

Noodtoetsen

De volgende bewerkingen zullen een noodmelding versturen naar de meldkamer

Toets	Beschrijving
4 + 6	Bij gelijktijdig induwen van beide knoppen, gedurende ten minste 2 seconden wordt er een Brand alarm gegenereert
7 + 9	Bij gelijktijdig induwen van beide knoppen, gedurende ten minste 2 seconden, wordt er een Nood alarm gegenereert
 + 	Bij gelijktijdig induwen van beide knoppen, gedurende ten minste 2 seconden, wordt er een Paniek alarm gegenereert



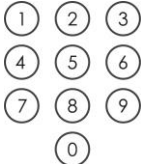

Functionele toetsen



Toets	Beschrijving
1/2/3/5	Wordt gebruikt voor het inschakelen van een groep zones (standaard) of om een activatie uit te voeren van een voorgeprogrammeerde serie van commando's (macros). Om te activeren druk 2 seconden op de toetsen. OPMERKING: Wanneer er zowel groep inschakelingen en macro's gedefinieerd zijn in het paneel zal er bij het indrukken van een knop enkel de macro's geactiveerd worden.
	Nummerieke toetsen die gebruikt worden voor het ingeven van numerieke codes (inschakelen, uitschakelen of wordt gebruikt voor het activeren van specifieke functies)







Bediendeel instellingen

Opmerking: De volgende instellingen dienen per bediendeel dat aangesloten is op het systeem apart ingesteld te worden.

➤ Volg volgende procedure wanneer het bediendeel in rust is:

1. Druk op  gedurende twee seconden tot het instelling menu van het bediendeel verschijnt
2. Selecteer het relevante icoon door gebruik te maken van de    toetsen:

	Helderheid
	Contrast
	buzzer volume bediendeel

3. Druk op .
4. Druk op de    toetsen om het niveau aan te passen.
5. Druk op  om de wijzigingen op te slaan.
6. Druk op   om de bediendeelinstellingen te verlaten.

Proximity Tag bediening

Presenteer de Proximity Tag aan het bediendeel (na ontwaken van bediendeel) zoals aangegeven in de volgende illustratie.

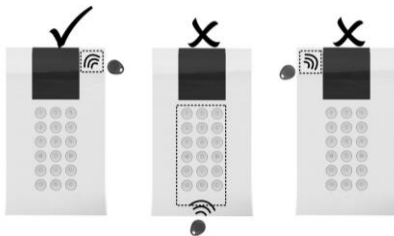

Figuur 8

Slaap Mode

Voor het verlengen van de batterijduur van het bediendeel is er een slaap mode functie ontwikkeld. Standaard instelling is ingesteld op 10 seconden, hierna zal het bediendeel na de laatste toetsaanslag de display en led's uitschakelen.

Vervangen van de batterijen

1. Verwijder de bevestigingsschroef welke de montage beugel vergrendelt aan het bediendeel (zie Figuur 1).
2. Schuif het bediendeel naar boven toe en verwijder het van de montage beugel.
3. Verwijder de afdekplaat van het batterijcompartiment.
4. Ontkoppel de batterijkabel van de batterijconnector.
5. Vervang de batterijen terwijl u oplet voor de polariteit van de batterijen (zie Figuur 9).

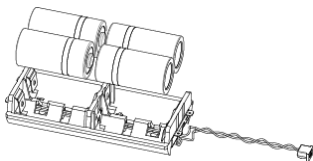

Figuur 9

6. Verbind de batterijkabel met de batterijconnector.
7. Sluit het batterij compartiment en plaats het bediendeel terug op de montage beugel. Vergrendel het bediendeel met de schroef.

OPGELET: Gevaar voor explosie indien u de batterij vervangt door een verkeerd type. Vernietig de gebruikte batterijen volgens de lokale geldende richtlijnen.

Wijzigen van de bediendeelinstellingen

Elke wijziging uitgevoerd op het niveau van de bediendeelinstellingen vereisen dat er een update uitgevoerd wordt op het bediendeel zelf.

U kan deze activeren door gedurende 2 sec op de toets



te drukken. Het paneel zal dan de update naar het bediendeel sturen.

Technische specificaties

Electrisch	
Batterij Type	CR123, 3V Lithium batterij (x 4)
Stroomverbruik	Standby current 9µA, Max current 150 mA
Uitgangsvermogen	868.65MHz: 10 mW
Frequentie	433.92, 868.65, 915 MHz
Modulatie Type	OOK
Levensduur batterij	3 jaar
Lage batterij indicatie	2,6 V
Proximity RF frequentie	13.56 MHz
Fysisch	
Afmetingen (HxWxD)	180 x 115 x 35 mm (7.1 x 4.5 x 1.4")
Gewicht (Inclusief batterijen)	0,435 kg
Omgeving	
Werkings temperatuur	-10°C tot 55°C (14°F tot 131°F)
Opslagtemperatuur	-20°C tot 60°C (-4°F tot 140°F)
Vochtigheidsbereik	Gemiddelde relatieve vochtigheid: 75%
Standaard compliance	EN 50131-1, EN 50131-3 klasse 2, milieuklasse II, EN 50131-6 type C, EN 50131-5-3, PD6662:2017
Certificatie-instelling	Applica Test & Certification

Bestelinformatie

Model	Beschrijving
RW432KPP400A	WL Panda Prox bediendeel voor LightSYS, 433
RW432KPP800A	WL Panda Prox bediendeel voor LightSYS, 868

Standaard Conformiteit

RED conformiteitsverklaring:

RISCO Group bevestigt dat dit product in lijn is met de essentiële verplichtingen en andere belangrijke voorzieningen van de 2014/53/EU richtlijnen. Voor de conformiteitsverklaring zie onze website: www.riscogroup.com

Standard Limited Product Warranty

RISCO Ltd., its subsidiaries and affiliates (“RISCO”) guarantee RISCO’s hardware products to be free from defects in materials and workmanship when used and stored under normal conditions and in accordance with the instructions for use supplied by RISCO, for a period of (i) 24 months from the date of connection to the RISCO Cloud (for cloud connected products) or (ii) 24 months from production (for other products which are non-cloud connected), as the case may be (each, the “**Product Warranty Period**” respectively).

Contact with customers only. This Product Warranty is solely for the benefit of the customer who purchased the product directly from RISCO, or from any authorized distributor of RISCO. Nothing in this Warranty obligates RISCO to accept product returns directly from end users that purchased the products for their own use from RISCO’s customer or from any installer of RISCO, or otherwise provide warranty or other services to any such end user. RISCO customer shall handle all interactions with its end users in connection with the Warranty, inter alia regarding the Warranty. RISCO’s customer shall make no warranties, representations, guarantees or statements to its customers or other third parties that suggest that RISCO has any warranty or service obligation to, or any contractual privity with, any recipient of a product.

Return Material Authorization. In the event that a material defect in a product shall be discovered and reported during the Product Warranty Period, RISCO shall, at its option, and at customer’s expense, either: (i) accept return of the defective Product and repair or have repaired the defective Product, or (ii) accept return of the defective Product and provide a replacement product to the customer. The customer must obtain a Return Material Authorization (“**RMA**”) number from RISCO prior to returning any Product to RISCO. The returned product must be accompanied with a detailed description of the defect discovered (“**Defect Description**”) and must otherwise follow RISCO’s then-current RMA procedure in connection with any such return. If RISCO determines in its reasonable discretion that any Product returned by customer conforms to the applicable warranty (“**Non-Defective Products**”), RISCO will notify the customer of such determination and will return the applicable Product to customer at customer’s expense. In addition, RISCO may propose and assess customer a charge for testing and examination of Non-Defective Products.

Entire Liability. The repair or replacement of products in accordance with this warranty shall be RISCO’s entire liability and customer’s sole and exclusive remedy in case a material defect in a product shall be discovered and reported as required herein. RISCO’s obligation and the Warranty are contingent upon the full payment by customer for such Product and upon a proven weekly testing and examination of the product functionality.

Limitations. The Product Warranty is the only warranty made by RISCO with respect to the Products. The warranty is not transferable to any third party. To the maximum extent permitted by applicable law, the Product Warranty does not apply and will be void if: (i) the conditions set forth above are not met (including, but not limited to, full payment by customer for the product and a proven weekly testing and examination of the product functionality); (ii) if the Products or any part or component thereof: (a) have been subjected to improper operation or installation; (b) have been subject to neglect, abuse, willful damage, abnormal working conditions, failure to follow RISCO’s instructions (whether oral or in writing); (c) have been misused, altered, modified or repaired without RISCO’s written approval or combined with, or installed on products, or equipment of the customer or of any third party; (d) have been damaged by any factor beyond RISCO’s reasonable control such as, but not limited to, power failure, electric power surges, or unsuitable third party components and the interaction of software therewith or (e) any delay or other failure in performance of the product attributable to any means of communications, provided by any third party service provider (including, but not limited to) GSM interruptions, lack of or internet outage and/or telephony failure.

BATTERIES ARE EXPLICITLY EXCLUDED FROM THE WARRANTY AND RISCO SHALL NOT BE HELD RESPONSIBLE OR LIABLE IN RELATION THERETO, AND THE ONLY WARRANTY APPLICABLE THERETO, IF ANY, IS THE BATTERY MANUFACTURER’S WARRANTY.

RISCO makes no other warranty, expressed or implied, and makes no warranty of merchantability or of fitness for any particular purpose. For the sake of good order and avoidance of any doubt:

DISCLAIMER. EXCEPT FOR THE WARRANTIES SET FORTH HEREIN, RISCO AND ITS LICENSORS HEREBY DISCLAIM ALL EXPRESS, IMPLIED OR STATUTORY, REPRESENTATIONS, WARRANTIES, GUARANTEES, AND CONDITIONS WITH REGARD TO THE PRODUCTS, INCLUDING BUT NOT LIMITED TO ANY REPRESENTATIONS, WARRANTIES, GUARANTEES, AND CONDITIONS OF MERCHANTABILITY, FITNESS FOR A PARTICULAR PURPOSE, TITLE AND LOSS OF DATA. WITHOUT LIMITING THE GENERALITY OF THE FOREGOING, RISCO AND ITS LICENSORS DO NOT REPRESENT OR WARRANT THAT: (i) THE OPERATION OR USE OF THE PRODUCT WILL BE TIMELY, SECURE, UNINTERRUPTED OR ERROR-FREE; (ii) THAT ANY FILES, CONTENT OR INFORMATION OF ANY KIND THAT MAY BE ACCESSED THROUGH THE PRODUCT BY CUSTOMER OR END USER SHALL REMAIN SECURED OR NON DAMAGED. CUSTOMER ACKNOWLEDGES THAT NEITHER RISCO NOR ITS LICENSORS CONTROL THE TRANSFER OF DATA OVER COMMUNICATIONS FACILITIES, INCLUDING THE INTERNET, GSM OR OTHER MEANS OF COMMUNICATIONS AND THAT RISCO'S PRODUCTS, MAY BE SUBJECT TO LIMITATIONS, DELAYS, AND OTHER PROBLEMS INHERENT IN THE USE OF SUCH MEANS OF COMMUNICATIONS. RISCO IS NOT RESPONSIBLE FOR ANY DELAYS, DELIVERY FAILURES, OR OTHER DAMAGE RESULTING FROM SUCH PROBLEMS.

RISCO WARRANTS THAT ITS PRODUCTS DO NOT, TO THE BEST OF ITS KNOWLEDGE, INFRINGE UPON ANY PATENT, COPYRIGHT, TRADEMARK, TRADE SECRET OR OTHER INTELLECTUAL PROPERTY RIGHT

IN ANY EVENT RISCO SHALL NOT BE LIABLE FOR ANY AMOUNTS REPRESENTING LOST REVENUES OR PROFITS, PUNITIVE DAMAGES, OR FOR ANY OTHER INDIRECT, SPECIAL, INCIDENTAL, OR CONSEQUENTIAL DAMAGES, EVEN IF THEY WERE FORESEEABLE OR RISCO HAS BEEN INFORMED OF THEIR POTENTIAL.

RISCO does not install or integrate the product in the end user security system and is therefore not responsible for and cannot guarantee the performance of the end user security system which uses the product.

RISCO does not guarantee that the product will prevent any personal injury or property loss by burglary, robbery, fire or otherwise; or that the product will in all cases provide adequate warning or protection.

Customer understands that a correctly installed and maintained alarm may only reduce the risk of burglary, robbery or fire without warning, but is not an assurance or a guarantee that such an event will not occur or that there will be no personal injury or property loss as a result thereof. Consequently RISCO shall have no liability for any personal injury, property damage or loss based on a claim that the product fails to give warning.

No employee or representative of RISCO is authorized to change this warranty in any way or grant any other warranty.

Contacting RISCO Group

RISCO Group is committed to customer service and product support. You can contact us through our website www.riscogroup.com or via the following RISCO branches:

Belgium (Benelux)

Tel: +32-2522-7622

support-be@RISCOgroup.com

China (Shanghai)

Tel: +86-21-52-39-0066

support-cn@RISCOgroup.com

France

Tel: +33-164-73-28-50

support-fr@RISCOgroup.com

Israel

Tel: +972-3-963-7777

support@RISCOgroup.com

Italy

Tel: +39-02-66590054

support-it@RISCOgroup.com

Spain

Tel: +34-91-490-2133

support-es@RISCOgroup.com

United Kingdom

Tel: +44-(0)-161-655-5500

support-uk@RISCOgroup.com

USA

Tel: +1-631-719-4400

support-usa@RISCOgroup.com

This RISCO product was purchased at:

© RISCO Group 2021. All rights reserved. No part of this document may be reproduced in any form without prior written permission from the publisher.

