



Knowledge Base

powered by  **ALARM.COM**

Alarm.com Wireless Video Doorbell (ADC-VDB780B) - Installation Guide

Use this guide to assist with the installation of your ADC-VDB780B Wireless Video Doorbell.

In the box

- ADC-VDB780B Wireless Video Doorbell
- ADC-VDB780B mounting plate
- 10° tilt wedge
- Battery pack
- Charging cable
- Mounting screws (2)
- Mounting anchors (2)
- Wedge screws (4)
- Quick start guide



[https://answers.alarm.com/Partner/Installation_and_Troubleshooting/Video_Devices/Alarm.com_Wireless_Video_Doorbell_\(A...](https://answers.alarm.com/Partner/Installation_and_Troubleshooting/Video_Devices/Alarm.com_Wireless_Video_Doorbell_(A...)

Updated: Wed, 30 Aug 2023 11:32:17 GMT



Pre-installation checklist

Important: A service package that includes Video Analytics and the *Doorbell Cameras* add-on is required to enroll the ADC-VDB780B.

- ADC-VDB780B and included accessories
- Drill/Screwdriver
- Level
- Pencil
- Wi-Fi connection to broadband (Cable, DSL, or Fiber Optic) internet
- A computer, tablet, or smartphone with Wi-Fi





The Alarm.com Smart Chime (ADC-W115C) is required for installation.

[Click here for instructions](#)

Installation

Important: If you have not installed the Alarm.com Smart Chime yet, do that now. For installation instructions, see [Alarm.com Smart Chime \(ADC-W115C-INT\) - Installation Guide \(International\)](#).

Power on the Wireless Video Doorbell

1. Remove the Wireless Video Doorbell (VDB780B) from the packaging.
2. Separate the battery pack from the VDB780B body.

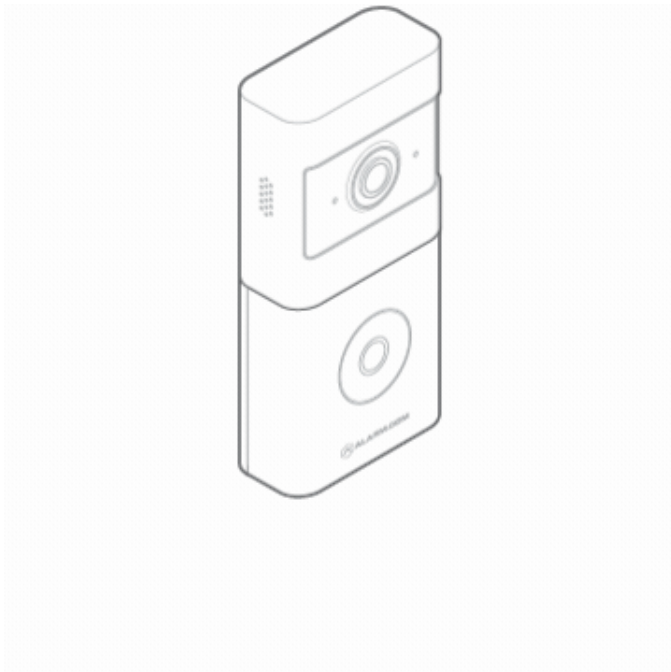

3. Activate the battery by plugging in the Micro USB charger to a wall outlet and connecting it to the battery.

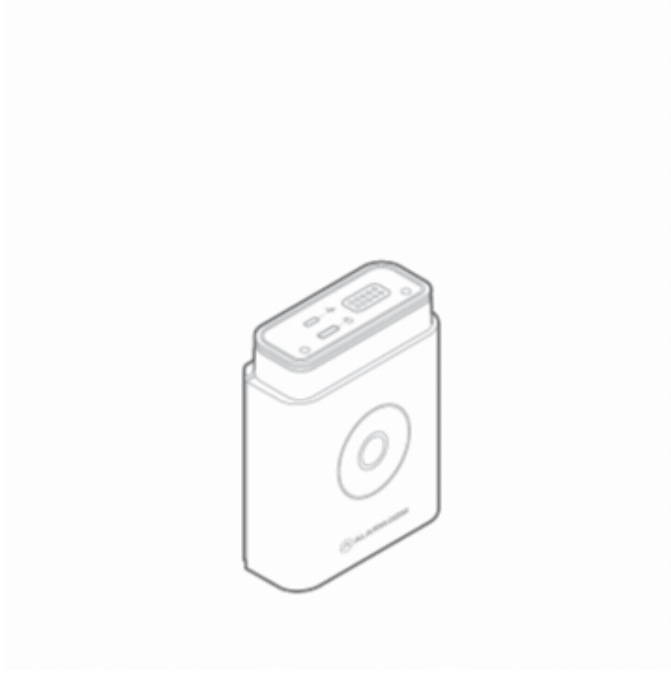

4. Check the top of the battery pack for a blue protective film. If present, please remove the film and discard it.
5. Press the doorbell button on the front of the battery. If the button LED alternates between red and blue, the battery pack must be recharged prior to completing the installation. For more information, see [Charging the battery](#).
6. If the button LED isn't alternating blue and red, reconnect the battery pack to the VDB780B body.
7. After the button LED stops flashing red, press and release the doorbell button and ensure the LED lights up red.

Connect the Wireless Video Doorbell to the Alarm.com Smart Chime

1. Verify the Wireless Video Doorbell (VDB780B) is less than 10 feet away from the Alarm.com Smart Chime (W115C).
2. Verify that the W115C has been installed and associated with an account.
3. To enable WPS mode, press and hold the VDB780B doorbell button firmly for greater than 30 seconds. The LED will begin flashing blue.



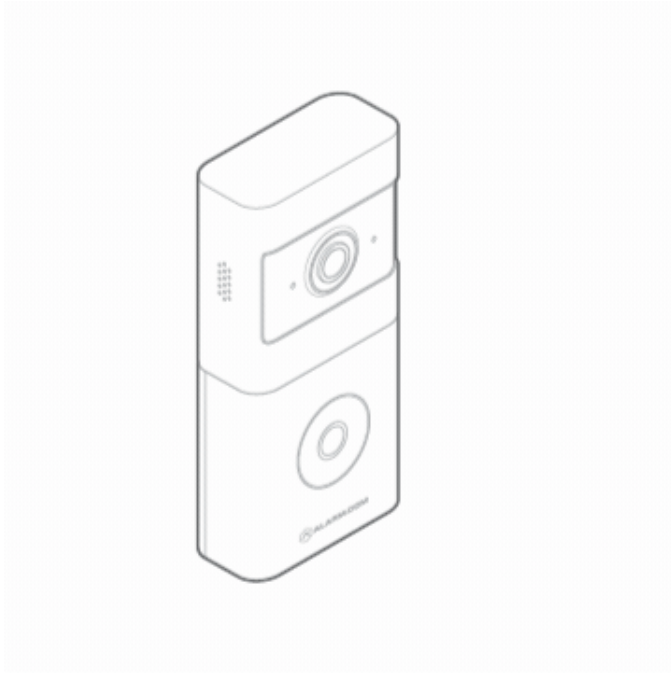

4. Press and release the WPS button located on the side of the W115C to enable WPS mode. The WPS LED will begin flashing rapidly.



5. If the pairing is successful, the W115C Devices LED will quickly blink 3 times, and the VDB780B LED will begin blinking red and then turn solid green.



Enroll the Wireless Video Doorbell to the Account

Once the ADC-VDB780B is connected to the ADC-W115C, it can be enrolled to a customer account using the Customer app, Customer Website, or MobileTech app.

Method 1: Customer app ^

1. Log into the Customer app.
2. Tap **Video**.
3. Tap **⚙**.
4. Tap **Add Video Device**.
5. Tap **ADC-VDB780B**.
6. Follow the on-screen prompts for installing the video device.

Method 2: Customer Website ^

1. In an internet browser address bar, enter www.alarm.com/addcamera and log into the customer account.
Alternatively:
 - a. Log into the Customer Website.
 - b. Click **Video**.
 - c. Click **Settings**.
 - d. Click **Add Video Device**.
2. Find the ADC-VDB780B in the list or enter its MAC address and enter a name for the video device. If the ADC-VDB780B does not appear in the list, see [Video device is not found during installation](#).
3. Click **Install** to begin installing the ADC-VDB780B.
4. Follow the on-screen prompts for installing the video device.

Method 3: MobileTech app ^

1. Log into the MobileTech app.
2. Find the customer account.
3. Tap **Equipment**.
4. Tap **Add Devices**.
5. Tap **Video**.
6. Verify the ADC-VDB780B is connected to the network. For a guided network connection tutorial:
 - a. Using the *Select Video Device for Guided Installation Tutorial* dropdown menu, select the ADC-VDB780B.
 - b. Tap **Open Installation Tutorial**.
7. Find the ADC-VDB780B in the list or enter its MAC address. If the ADC-VDB780B does not appear in the list,



see [Video device is not found during installation](#).

8. Tap **Install** to begin installing the ADC-VDB780B.
9. After the device is successfully installed, it appears under *Recently Installed Video Devices*.
10. Tap the name of the video device to configure its post-install settings:
 - Configure Wi-Fi settings.
 - Rename the camera.
 - Request an image upload.
 - Configure Video Analytics or other recording rules.

Note: These settings can only be changed in the MobileTech app until 24 hours after enrollment. Any future changes will need to be made using the Customer Website.

Mount the Wireless Video Doorbell

Plan, Level, & Mark

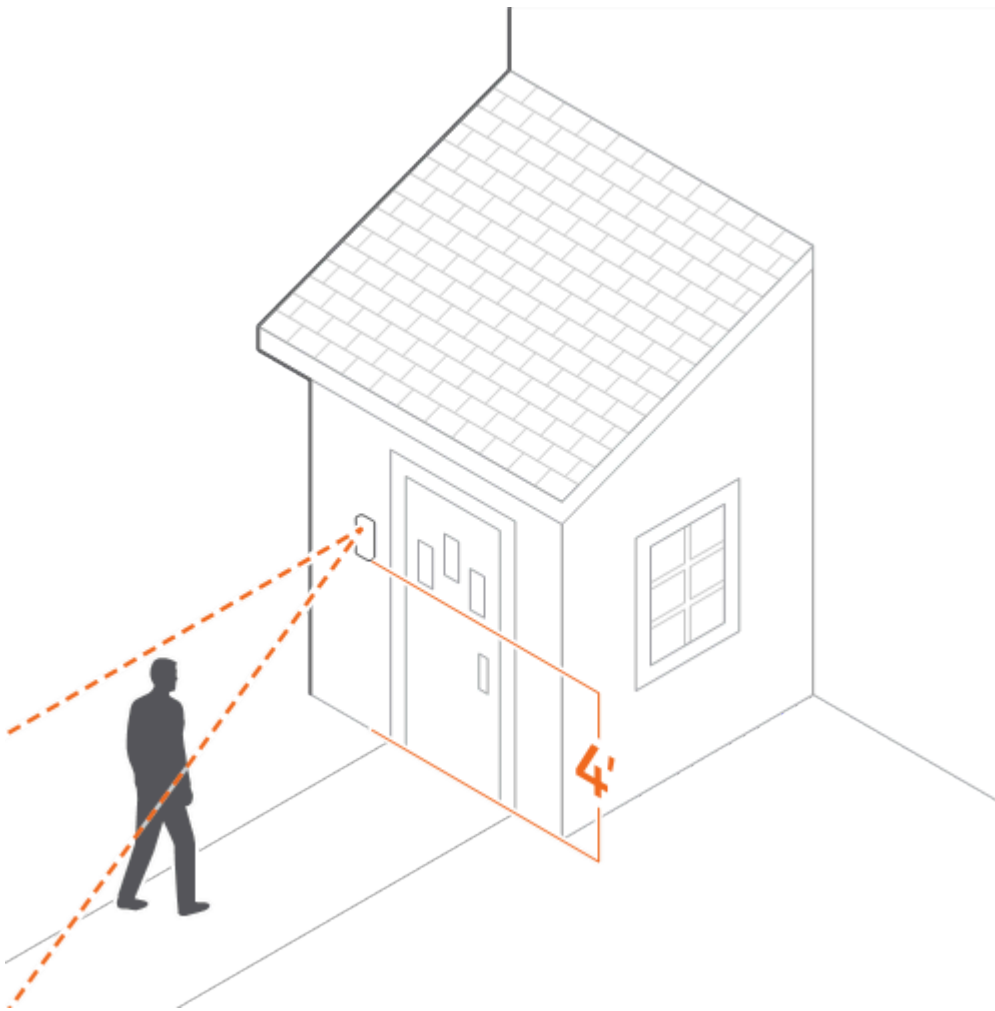

1. Identify a location on the side of your doorframe to mount your Wireless Video Doorbell (VDB780B). We recommend a position approximately 4 feet above the ground for an optimal field of view.
2. Place the mount at your desired location.
3. Use a level to ensure the mount is parallel to the ground.
4. Use a pencil to mark the two holes of the mount.

Tip: If you have someone to help you with the setup, use the Mobile App or Customer Website to start a live stream. You can place the VDB780B over your planned mounting position to assess the field of view before you start drilling.

There are two common mounting areas that can lead the Wireless Video Doorbell to be misaligned. The included 10° tilt wedge mount may be required to point the Wireless Video Doorbell properly.

Mounting on an elevated entryway: ^

If the installation location has stairs or a ramp leading to the entryway, a tilt wedge will likely be needed to help focus the Wireless Video Doorbell on the visitors' approach path.

A doorbell mounted on an elevated entryway may wake up too often due to constant or uninteresting motion.



Visitors may only be detected once they are directly in front of the entryway and clips will not contain their approach to the door.

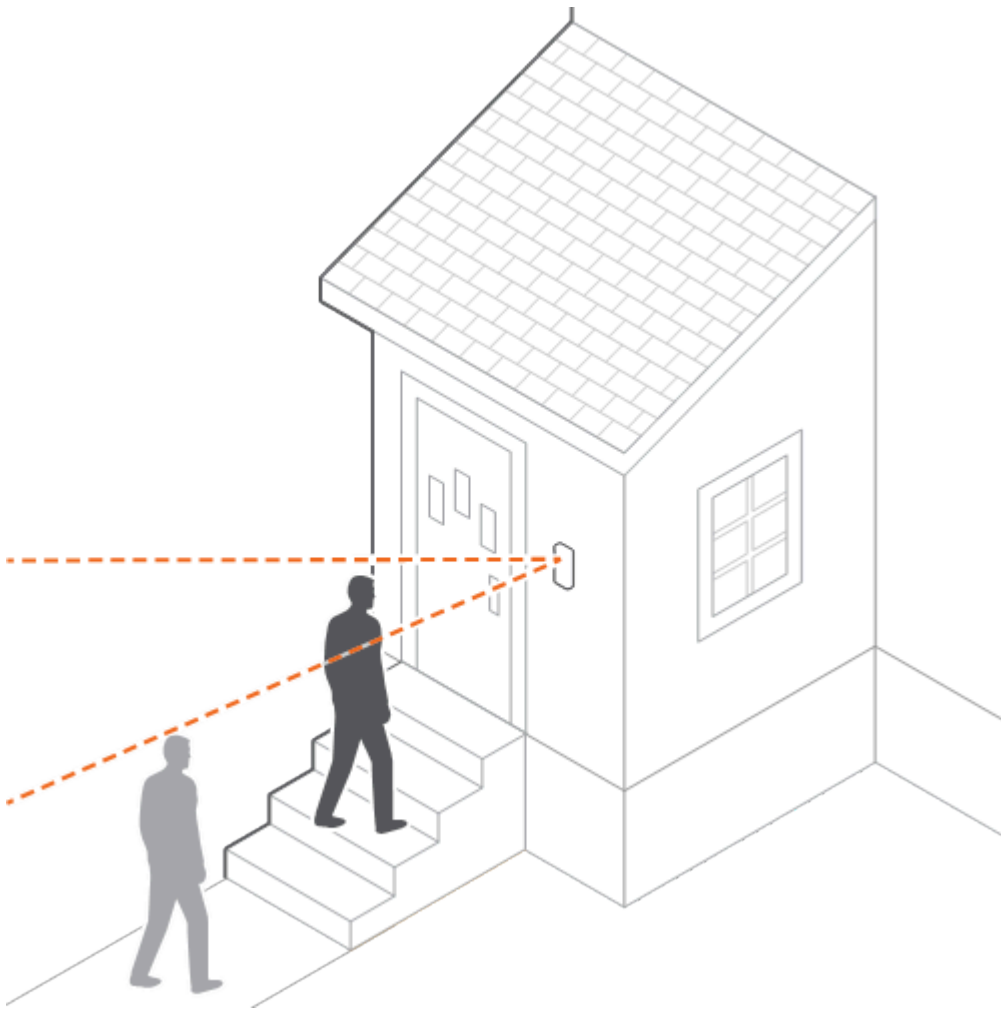

Install the 10° tilt wedge mount included in the doorbell's packaging to focus the PIRs downward to reduce unwanted wake-ups, and improve recorded clips.



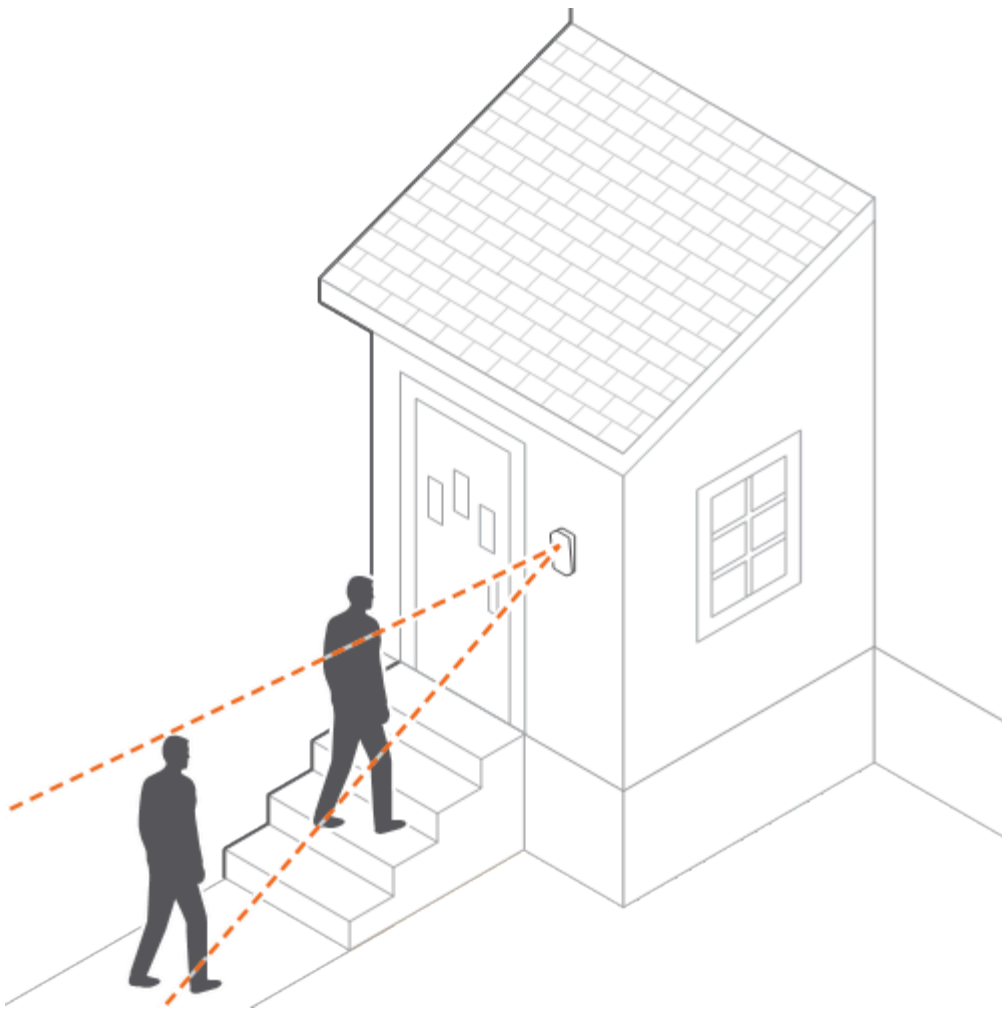

Mounting on an entry with a sided facade: ^

Sided facades can misalign the Wireless Video Doorbell and lead to missed detections.



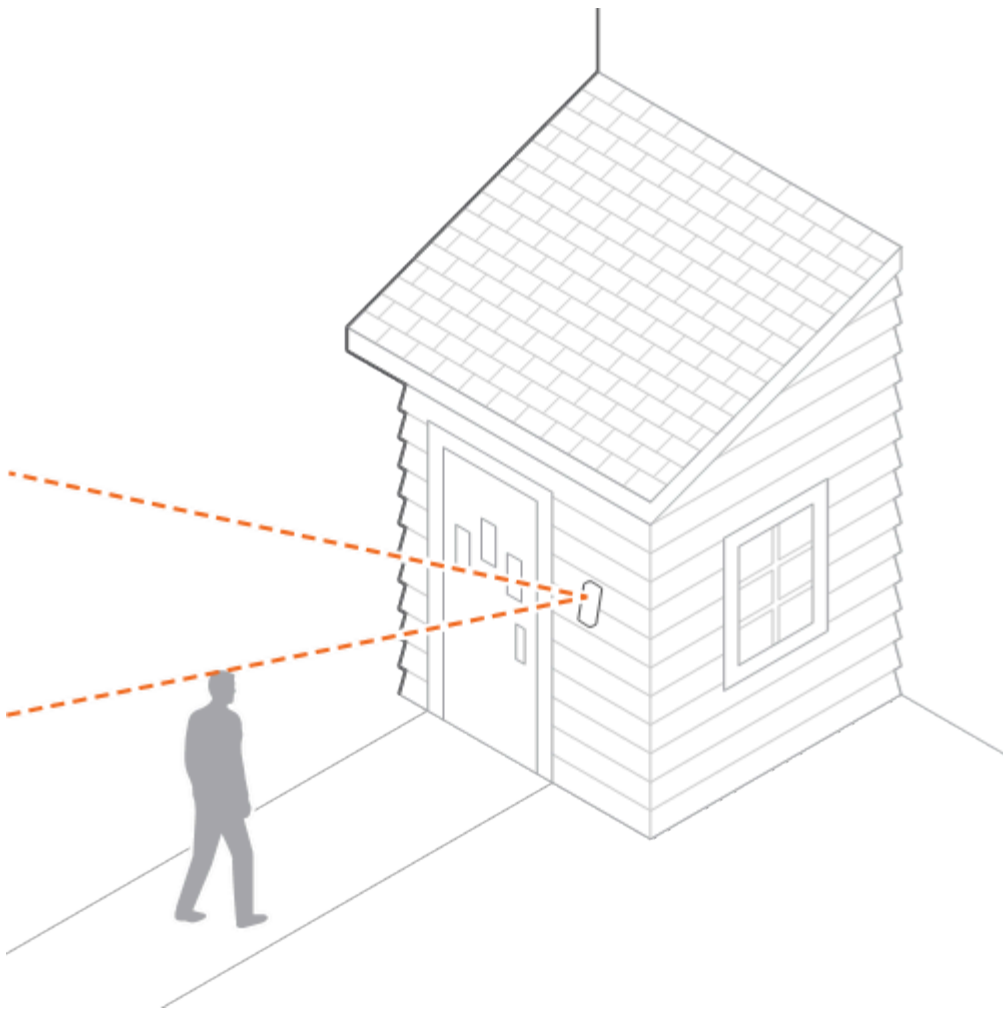

Install the 10° tilt wedge mount included in the doorbell's packaging to focus the PIRs downward.



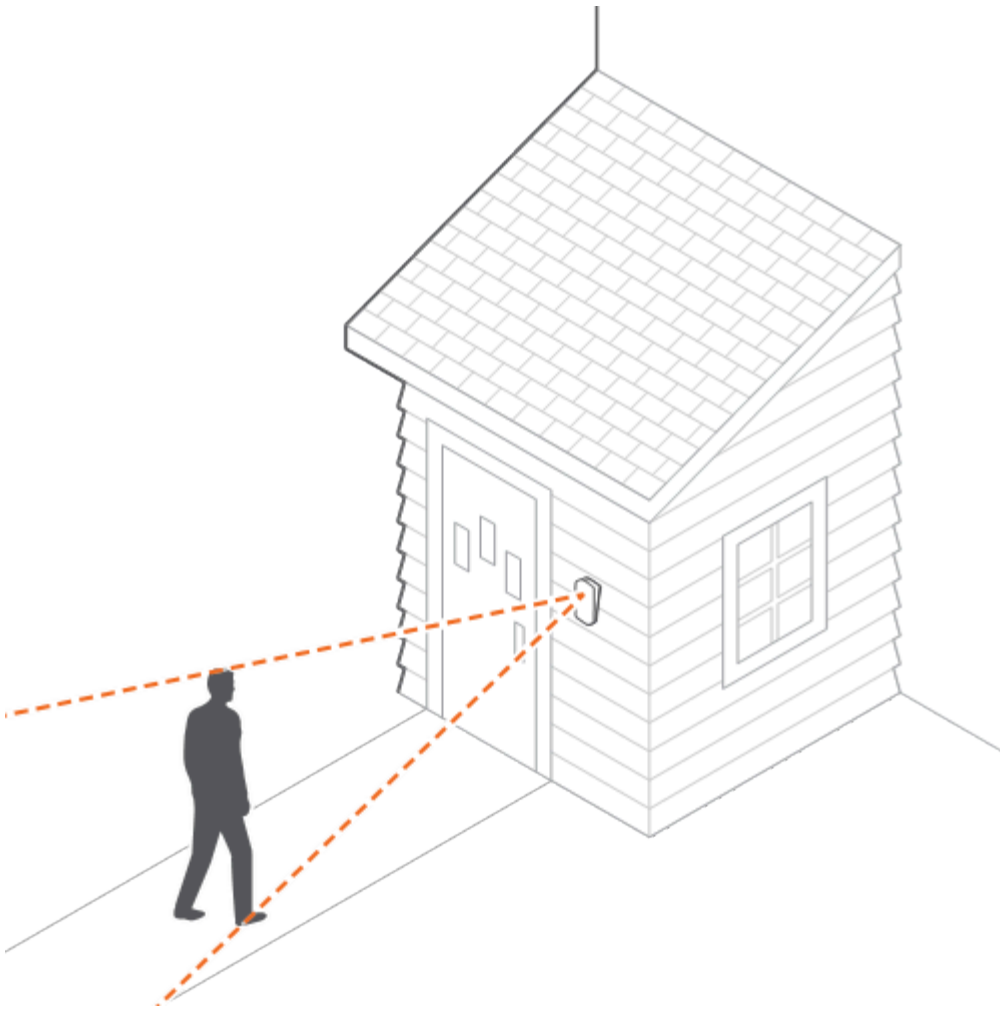

Drill

1. Use a 1/4" drill bit to create appropriately sized holes for the supplied anchors at your marked locations.
2. Insert the anchors.

Screw

1. Place the mount over the two anchors.
2. Use the supplied screws to secure the mount in place.

Attach the Wireless Video Doorbell to the Mount

1. Align the prongs on the back of the Wireless Video Doorbell (VDB780B) with the 4 rectangular slots in the mount.
2. Push the VDB780B into the slots and slide down, until the device clicks into place.
3. Slide the latch on the bottom of the mount to secure the VDB780B in place.



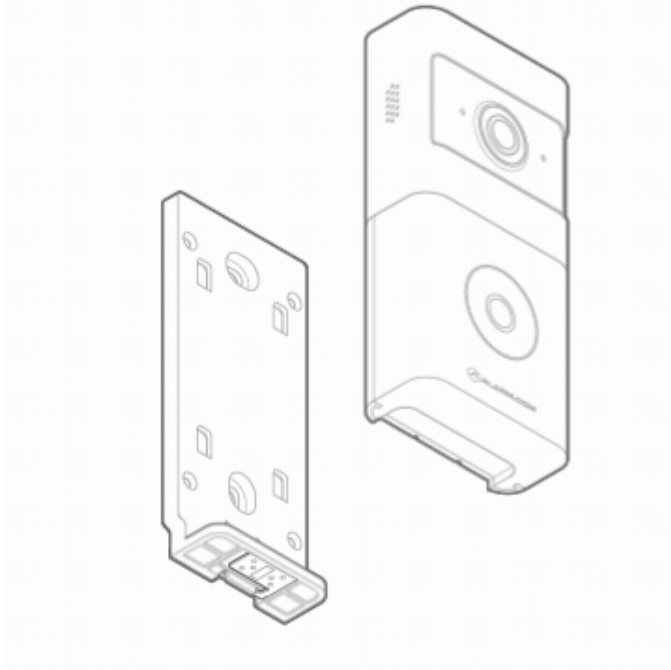

Confirm Battery Charge

1. If the battery was not fully charged as part of the Power on the Wireless Video Doorbell section, please remove the VDB780B and follow the instructions in the Charging the Battery section.

Charging The Battery

Charging Requirements

- A 5V/1.5A USB wall charger
- The supplied charging cable

Charging Steps

Note: A fully depleted battery takes approximately 7 hours to charge.

1. Unlatch the bottom of the mount.



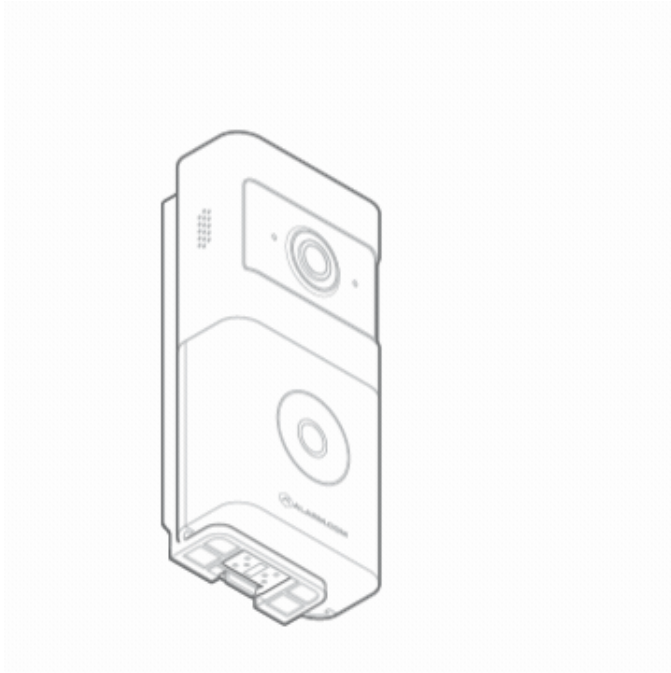

2. Remove the VDB780B from the mount.
3. Separate the battery pack from the VDB780B body.

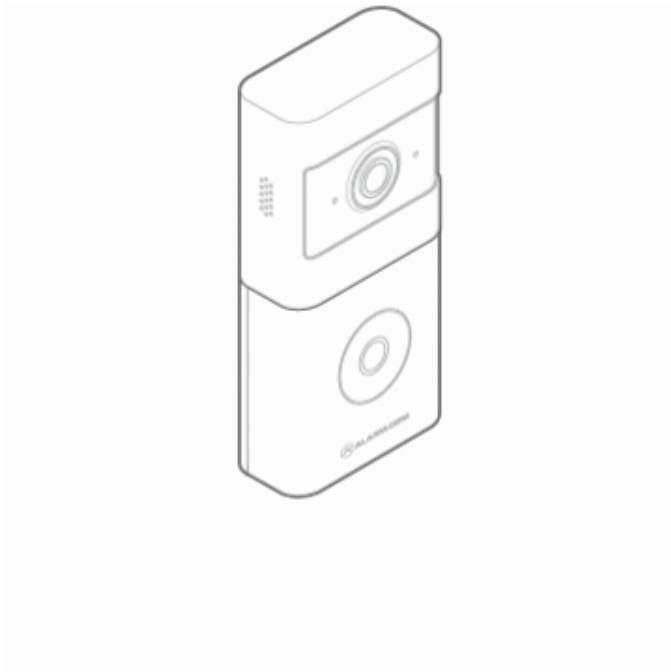

4. Plug the supplied micro USB cable into the battery pack.



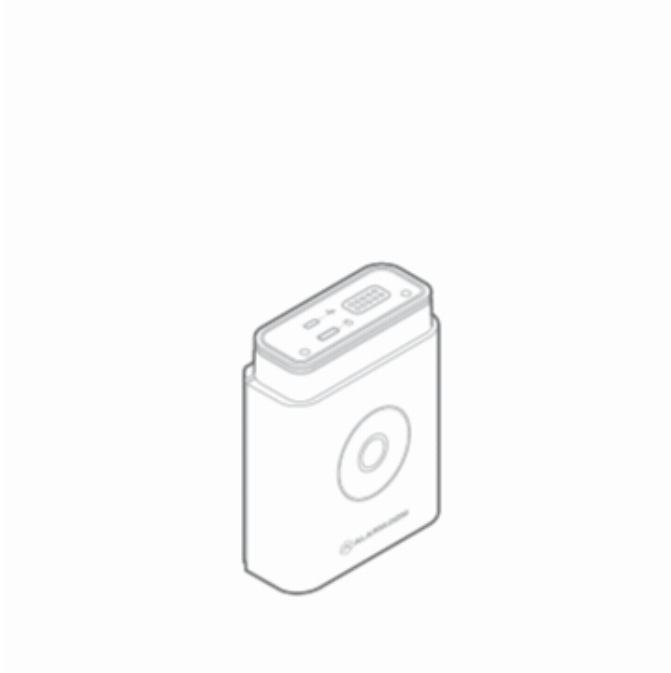

5. Plug the USB end of the cable into a USB wall charger and insert the charger into an outlet.
6. The charging LED, located on the top of the battery pack, will be solid orange while the device is charging. The charging LED will turn solid green when charging has completed.







LED Guide

1. Top LED
2. Button LED





Button light guide





Operational States

Mode	Description	Button LED behavior
Standby or off	The camera is in standby mode (normal operation) or the battery is drained and requires recharging.	Off 
Local connection	The camera has a local network connection.	Solid green 
No local connection	The camera does not have a local network connection.	Solid red 
Low battery	The camera's battery is low and requires a recharge.	Alternating red and blue 
Connecting to network	The camera is powered on and connecting to the network.	Blinking red 
WPS mode	The camera is in WPS pairing mode. To enter this mode, press and hold the button for 30-45 seconds.	Blinking blue 
AP mode	The camera is in AP pairing mode. To enter this mode, press and hold the button for 46-60 seconds.	Blinking white 





Mode	Description	Button LED behavior
Power cycle	The camera is being power cycled. To enter this mode, press and hold the button for 61-75 seconds.	Blinking yellow 
Factory reset	The camera resetting to factory default. To enter this mode, press and hold the button for 76-180 seconds.	Alternating red and green 
Firmware upgrade	The camera's firmware is being upgraded.	Blinking yellow rapidly 

Charging States

Mode description	Top LED Behavior	Button LED behavior
<p>Charging</p> <p>The battery pack is plugged in and charging.</p>	<p>Solid orange</p> 	<p>On button press</p> <p>Solid green = >75% charged</p>  <p>Solid yellow = 75%-20% charged</p>  <p>Alternating red and blue = <20% charged</p> 



Mode description	Top LED Behavior	Button LED behavior
<p>Fully charged</p> <p>The battery pack is fully charged.</p>	<p>Solid green</p> 	<p>On button press, solid green</p> 
<p>Failure charging</p> <p>The battery pack stopped charging because the device was plugged in too long. This may signal that there is an issue with your battery pack. Remove the charging cabled and re-attempt charging after an hour. If you see the same behavior, please contact your provider.</p>	<p>Alternating orange and green</p> 	<p>Alternating red and white</p> 
<p>Operational temperature range for charging exceeded</p> <p>The battery pack's internal temperature is either too hot or too cold. Please charge the battery pack in a room-temperature environment.</p>	<p>Solid green or solid orange</p>  	<p>Alternating red and yellow</p>  <p>or</p> <p>Alternating red and white</p> 