

H850

Operation Manual

YUNEEC

catalogue

Product Overview	3	Re-bind	25
H850 Drone.....	3	Data Pilot APP	28
T1 Transmitter	4	Main interface overview	28
Charge the Batteries	5	Video Link Interface.....	33
Charging the Drone Battery	5	Mission Flight Mode	35
Charging Box Screen Overview	5	Waypoint	35
Charging the T1 Battery via USB	5	Adjust the waypoint parameters.....	35
Assembly	6	Pattern.....	40
Assembling the Landing Gear	6	Survey Mode.....	40
Assembling the Motor Arms	6	Adjust the survey parameters	42
Installing the Flight Batteries	6	Corridor Scans	48
Payload Introduction	6	Structure Scans	51
Visible Light Camera	7	Other functions of the Plan Panel ...	54
Thermal Imaging Camera	9	Execute the flight mission	55
Variable-focus Camera	9	Operations in mission flight mode	56
Gimbal Assembly /disassembly	10	Breakpoint Continuation	58
Pre-Flight Preparation	11	Setting Interface	59
Power ON/OFF.....	11	General	59
Calibrating the Compass.....	12	Offline Maps	61
CORS Network Binding	14	Version	64
Environment Requirement.....	16	GNSS RTK	64
Take Off	17	ST16 Radio	64
Optimal Transmission Range.....	17	Calibration	65
Take Off OPTION 1.....	18	Vehicle	66
Take Off OPTION 1.....	18	Summary	69
Control the Drone	19	RC Mode	69
ANGLE MODE.....	19	Sensors	70
SPORT MODE	19	Safety	70
RTL MODE.....	19	Attachment	74
MANUAL MODE.....	19	Specification	74
Indoor flight.....	20	LED Status Indication.....	76
Go to Location flight	21	Disclaimer and Statement	77
Orbit Flight.....	22		
ROI Flight	23		
Land	24		
Emergency Motor Stop	24		
Gimbal Control	25		
Gimbal Camera Tilt Control	25		
Gimbal Camera Pan Control	25		

Overview

H850 Drone

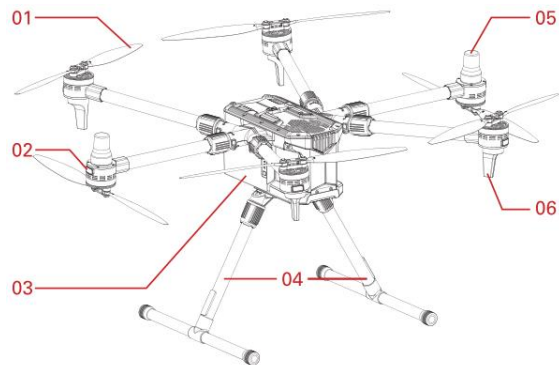

Top view

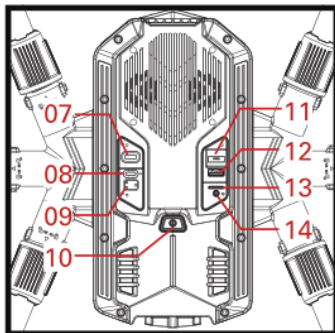

Bottom view

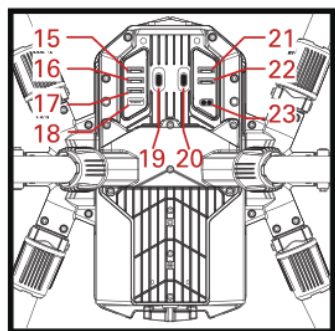

- 01** Propeller
- 02** LED Status Indicator
- 03** Battery Chamber
- 04** Landing Gear
- 05** RTK Antennas
- 06** OFDM Antennas
- 07** Debug/Custom Type-C USB Port
- 08** Gimbal/Custom Type-C USB Port
- 09** Binding Button and LED Indicator
- 10** Power Button
- 11** GMAC Port
- 12** Type-A USB 3.0 Port
- 13** Micro SD Slot
- 14** AUX out Port
- 15** PWM & GPIO Port
- 16** UART Port
- 17** GMAC Port
- 18** Type-A USB 3.0 Port
- 19** Gimbal/Custom Type-C USB Port
- 20** Gimbal/Custom Type-C USB Port
- 21** PWM & GPIO Port
- 22** PWM & UART Port
- 23** XT30 Power Output Port
(19.8V-26.4V)

T-1 Transmitter

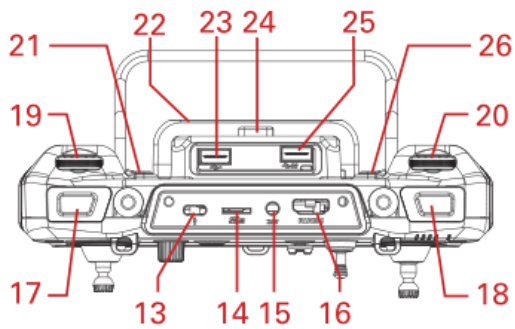
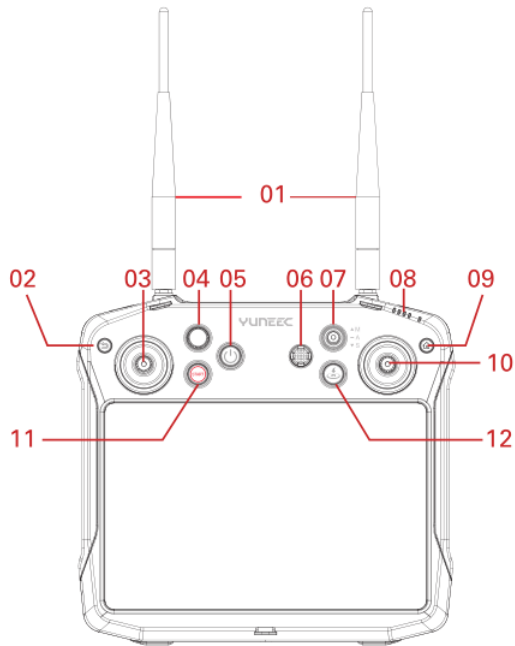

- 01** Antennas
- 02** Previous Button
- 03** Left Control Stick
- 04** Customizable Knob
- 05** Power Button
- 06** SD Button
- 07** Flight Mode Switch
- 08** Battery Level LEDs
- 09** Home Page Button
- 10** Right Control Stick
- 11** Motor Start/Stop Button
- 12** Return to Launch Button
- 13** Type C USB Charging Port
- 14** Micro SD Card Slot
- 15** Headphone Port
- 16** HDMI Port
- 17** Video Record Button
- 18** Shutter Button
- 19** Gimbal Tilt Control Knob
- 20** Gimbal Pan Control Knob
- 21** Hot Key/Gimbal Back to Centre
(Double click)
- 22** Battery
- 23** USB 2.0 Port
- 24** Battery Release Button
- 25** USB 3.0 Port
- 26** Customizable Button

Charging the Batteries

Charging the Drone Battery

Connect the Charge box to a 100-240V AC outlet. Then press the power button to switch on the charger.

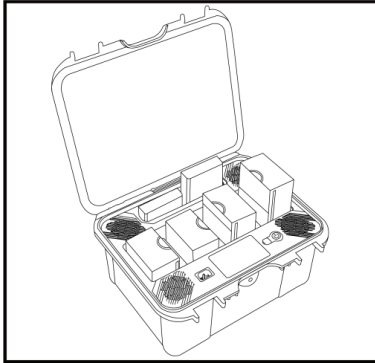

Plug the drone or transmitter battery into the charger port as illustrated.

The batteries will charge automatically.

Charge Box Screen Overview

Drone battery charge ports

Transmitter battery charge ports

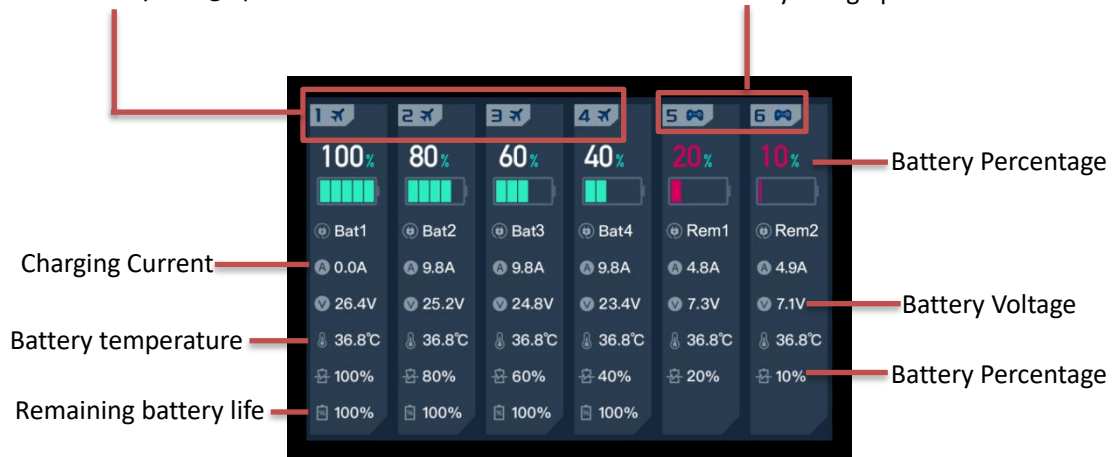

Charging the T1 Battery with via USB

The T1 battery can be charged using the Type C USB cable. Insert the connector into the Type C USB Charging Port, as shown below.

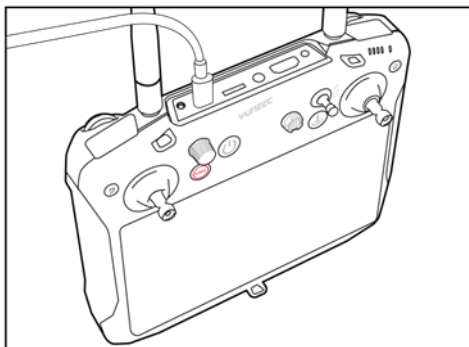

To check the charge status when the transmitter is shut down, short press the power button on the T-1 transmitter. The Battery Icon will be shown on the screen. Or operator the remaining power can be roughly estimated by the LED indicator on the transmitter.

Notice: The batteries are, combustible materials and must be replaced if they shown any signs of damage, swelling, or inability to fully charge.

Assembly

Assembling the Landing Gear

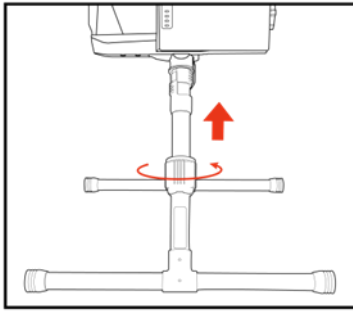

Insert the landing gear leg tube into the mount.
Secure the landing gear leg by fasten the nut.
Install the other landing gear leg using the same method.

Assembling the Motor Arms

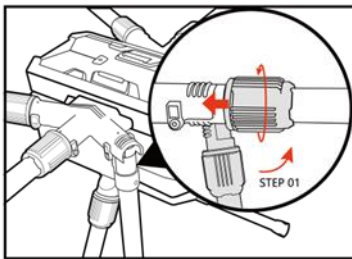

Unfold the motor arms upward and secure them using the twist nut.

Installing the Flight Batteries

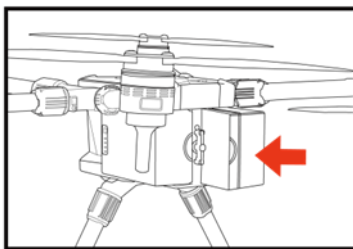

Select 2pcs of fully charged Flight Battery and insert the batteries into the Drone.
Then Lock the batteries to secure.

TIPS: Short click the button on the battery to roughly estimate the power level.

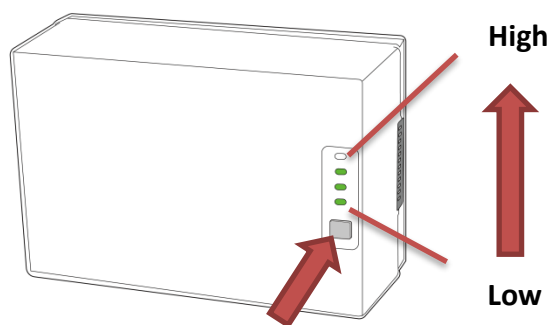
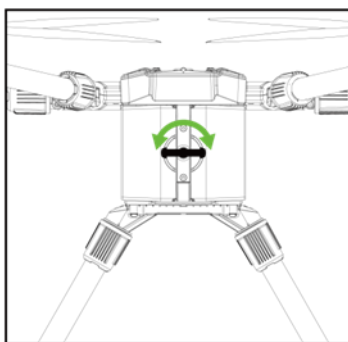

Payload Introduction

Various payload types can be attached to the H850 drone for different purposes. The following chapter will introduce some typical payloads of choice.

Visible light Camera

E90X

Yuneec's E90X camera is a one-inch CMOS sensor to capture high-quality images with 4k 10 bit in-camera colour processing. Images may be captured in JPEG or DNG format, or simultaneous capture of both formats. Video may be recorded in UHD, 2K, or HD resolutions at a variety of frame rates.

When the Gimbal is connected successfully the gimbal type will be shown correctly on the screen.

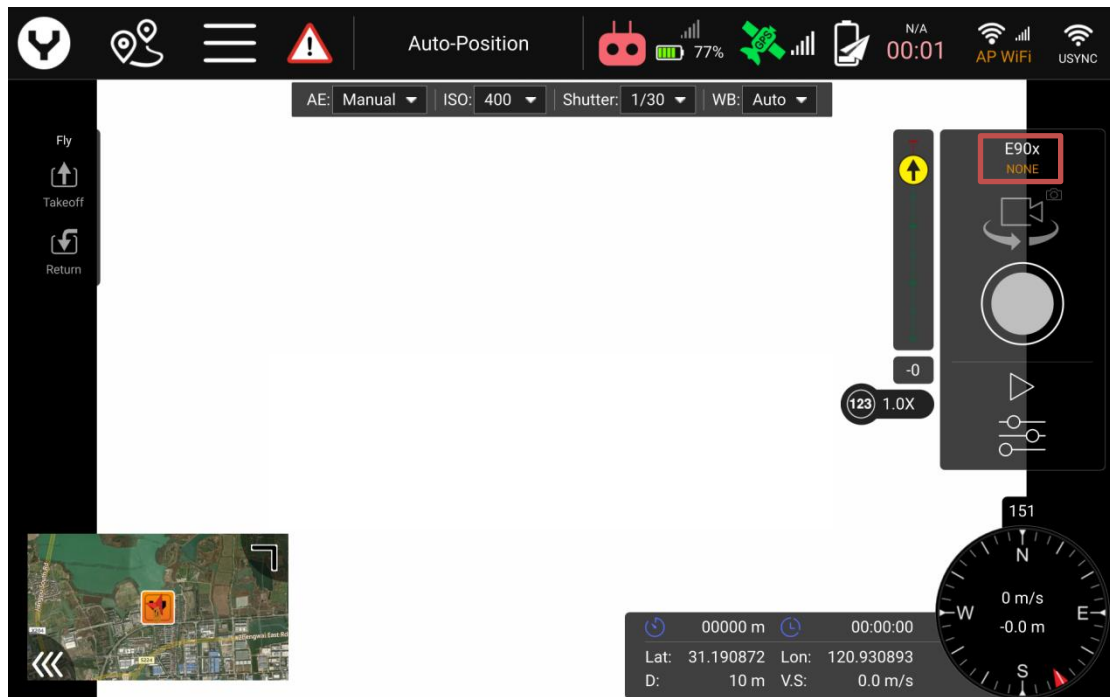

Tap the Camera Setting Button to set more photographic parameters.

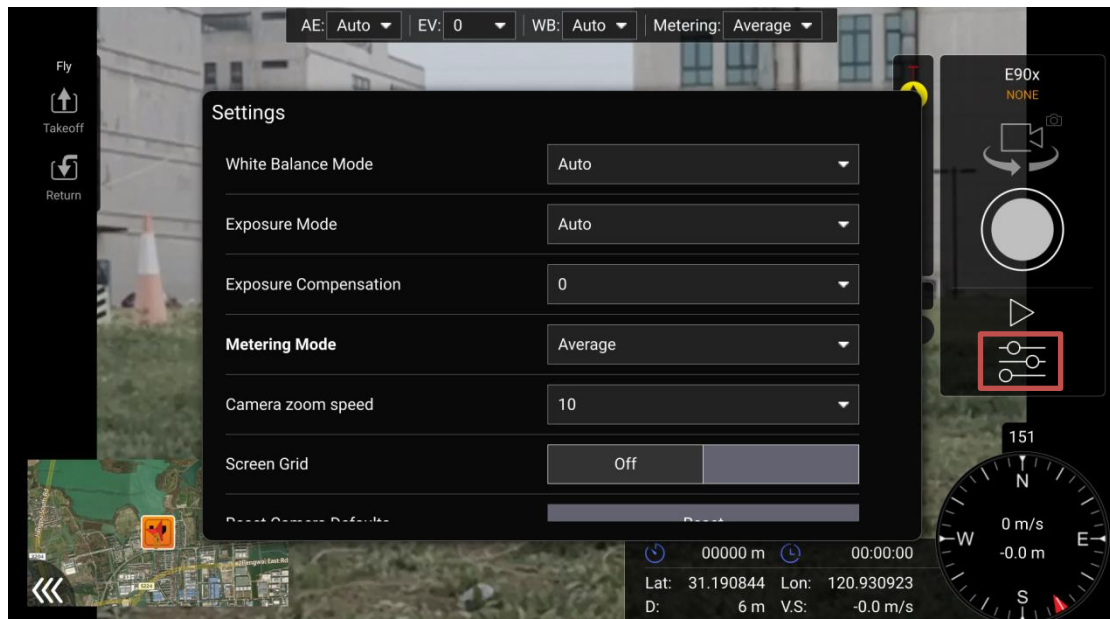

Notice:

For a more detailed introduction please refer to the corresponding Gimbal Operator Manual.

Digital Zoom function for E90x

Yuneec camera E90x is capable of digital zoom. A digital zoom is an ideal tool for many types of inspection, or getting a closer view of objects further than the camera is able to originally see. Digital zoom and optical zoom differ, as optical zoom uses the placement of lenses to generate a closer image whereas digital zoom enlarges pixels.

When using digital zoom, some loss of fine detail is normal and expected.

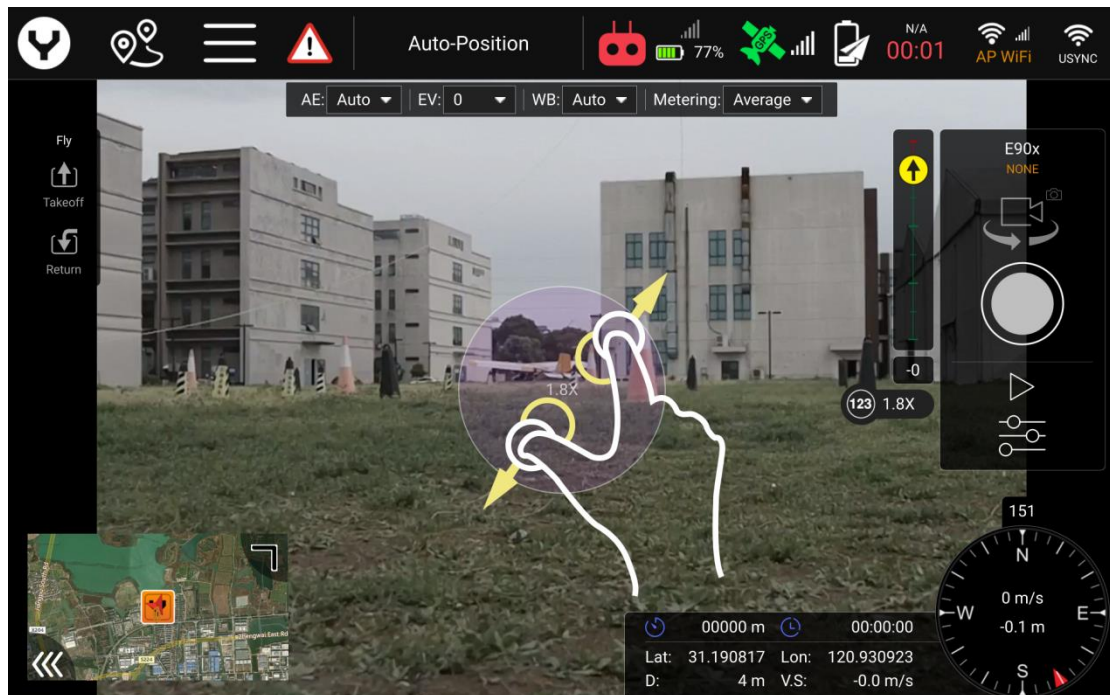

Pinch the screen to zoom, just as with any other mobile device. Depending on distance, there may be a small amount of latency in seeing the image zoom.

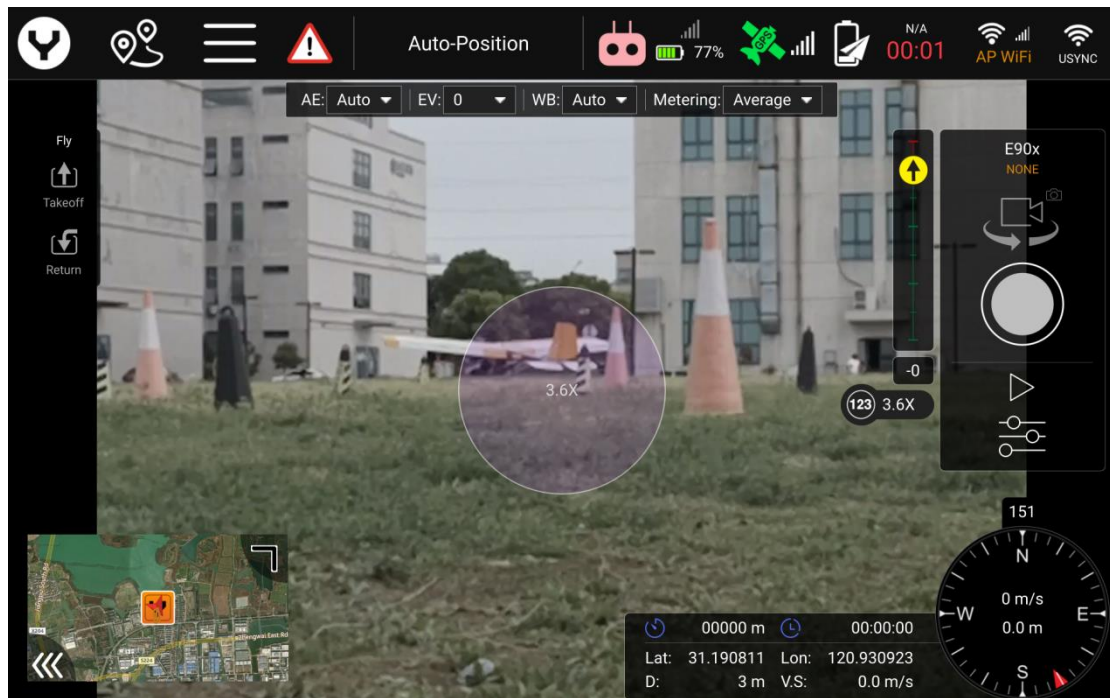

Thermal imaging camera

ETx/E10Tx/E10Tvx/E20Tvx

These series are an innovative combination of 3-axis gimbals, thermal imaging cameras and lo cameras. While the thermal imaging camera selectively measures the temperature in the image, enabling it to display relative temperature differences, the low-light RGB camera has a 20 times higher sensitivity than the human eye. It can still take excellent shots even in low light conditions. Both images are streamed live on the remote control at the same time and can be viewed separately as a picture-in-picture or as an overlay.

As same as the E90x gimbal, when the Gimbal is connected successfully, the gimbal type will be shown correctly on the screen; also tap the Camera Setting Button to set more photographic parameters both for thermal imaging and visible light camera.

Notice: Please refer to the corresponding Gimbal Operator Manual for a more detailed introduction Operator.

Variable-focus camera

E30Zx

The E30Zx is a powerful 30x zoom drone camera and makes it easy to zoom in on distant objects to gain increased detail. The compact camera housing contains a 1/2.8" CMOS sensor, which provides high-quality and stabilised recordings even in low light conditions. In addition to the 30x optical zoom, the camera offers a 6x digital zoom for flexible application options such as inspection, search and rescue operations, monitoring, people search, and much more.

As same as the E90x gimbal, When the Gimbal is connected successfully the gimbal type will be shown correctly on the screen; also tap the Camera Setting Button to set more photographic parameters.

Zoom function for E30Zx

Zoom in

Press and hold the Zoom-in button to increase the optical zoom. When increasing to 30X optical zoom, if the Zoom-in button is pressed again, the camera begins to increase digital zoom. The digital zoom can increase to a maximum of 6X..

Zoom out

Press and hold the Zoom-out button to decrease the optical zoom. When decreasing to 1X digital zoom, if the Zoom-out button is pressed again, the camera begins to decrease the optical zoom.

One Key to 1x Image

Tap the [] on the screen to return the camera to 1X zoom.

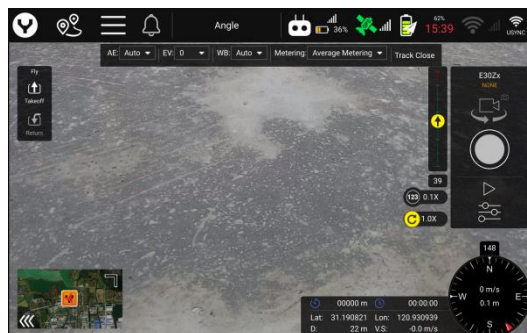
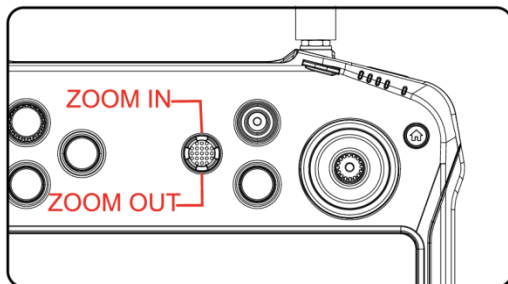

Notice: For a more detailed introduction please refer to the corresponding Gimbal Operator Manual.

Other payloads

Yuneec has several different camera/payload devices for use on the H850.

Get more information on www.yuneec.com.

SD CARD SELECTION

Yuneec recommends using a SDXC Class 10 UHS-3 micro SD card for recording 4k video. Using the UHS-3 card allows the camera buffer to record to the micro SD card faster, resulting in fewer buffer overruns.

Attaching / Detaching the gimbals

Attaching

Step 1

Find the Unlocked Mark etched on the Gimbal Yaw Motor and align the Mark Line with the front of the damping plate.

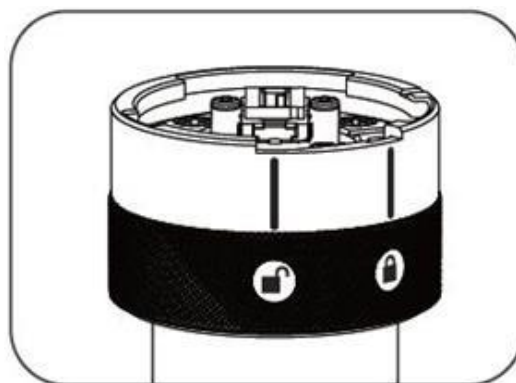

Step 2

Insert the Gimbal Yaw Motor into the damping plate and rotate it counterclockwise until the Mark Line of the Locked Mark aligns with the front of the damping plate to secure the gimbal.

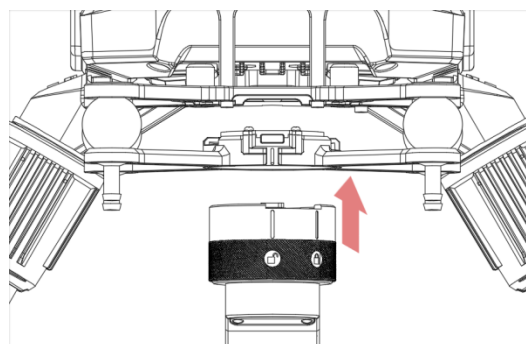

Step 3

Remove the lens protector

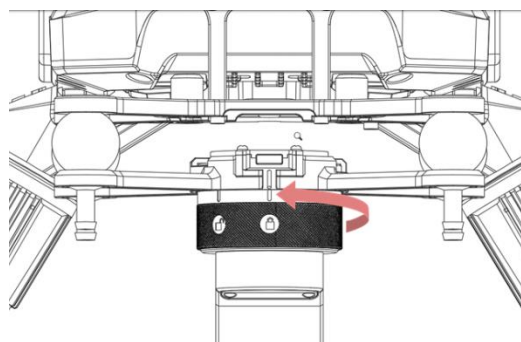

Detaching

Step 1

Hold the gimbal release button and rotate the Gimbal Yaw Motor clockwise until the Mark Line of the Unlocked Mark aligns with the front of the damping plate.

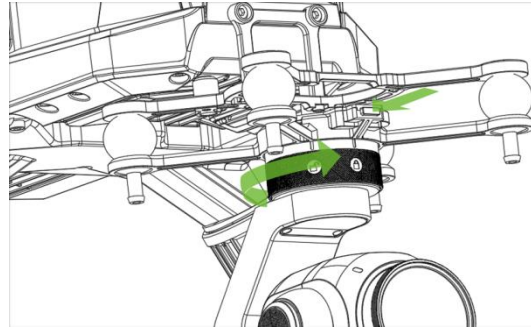

b

Step 2

Pull the gimbal out from the damping plate.

Notice: The X-connector series gimbal ????????? If the re-binding is needed please refer to the corresponding section in the OFDM Module binding chapter.

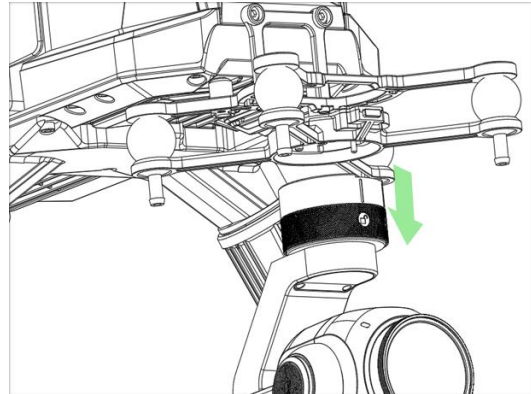

Pre-Flight Preparation

Power ON/OFF

NOTICE: Please make sure all firmware is the latest version. Firmware can be updated via the OTA update function, and the operator manual can be downloaded from the website: www.yuneec.com. The quick start guide does not replace the operator manual.

Press and hold the Power Button on the T1 to power On/Off

Press and hold the Power button on H850 drone to power On/Off

Notice: Always Power on the T1 before powering on the UAS.

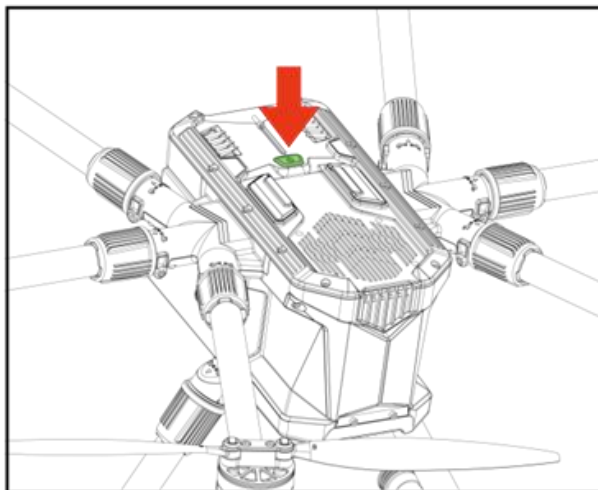

Calibrating the Compass

In the following situations recalibrating the Compass is suggested for flight safety:

1. Before the first flight, when you take the drone out of the box;
2. When feeling the drone is drifting after a long-distance flight;
3. The drone alarm advises a compass warning.
4. There are metal materials beside the drone during storage and transport.

Calibrate steps

Notice: Do not calibrate the compass in parking garages, close to a building or near roads with a metal core. For optimum performance, only calibrate the drone in open spaces, far away from power lines and other metal structures or concrete buildings.

Be sure to perform the compass calibration procedure at least 11 feet away from the nearest cell phone or other electronic devices to ensure proper calibration.

Step 1: After the drone and T1 Transmitter are connected, place the drone on a horizontal and stable surface, tap the setting icon, then tap the compass under the Sensors Item.

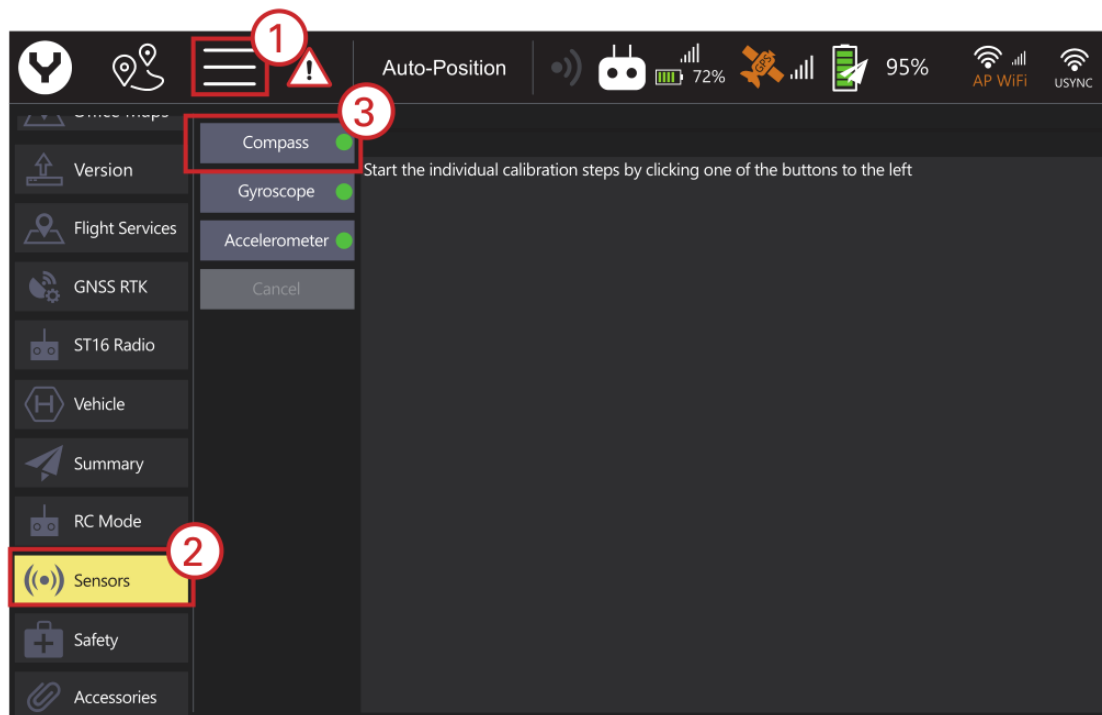

Step 2: Tap the OK button to start to calibrate

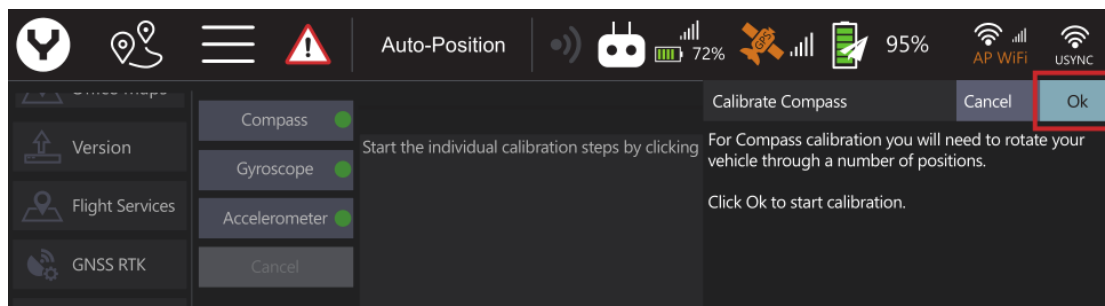

Step 3: Calibrating

Follow the onscreen display and instructions. During Compass calibration, the H850 will need to rotate along the specific axis which is shown by the LED of each Motor Arm, until a tone is heard to change to the next axis. Repeat this procedure for all six positions. A yellow box with a red arrow indicates the rotation axis, which is calibrating. A green box indicates a completed calibration.

During Calibration

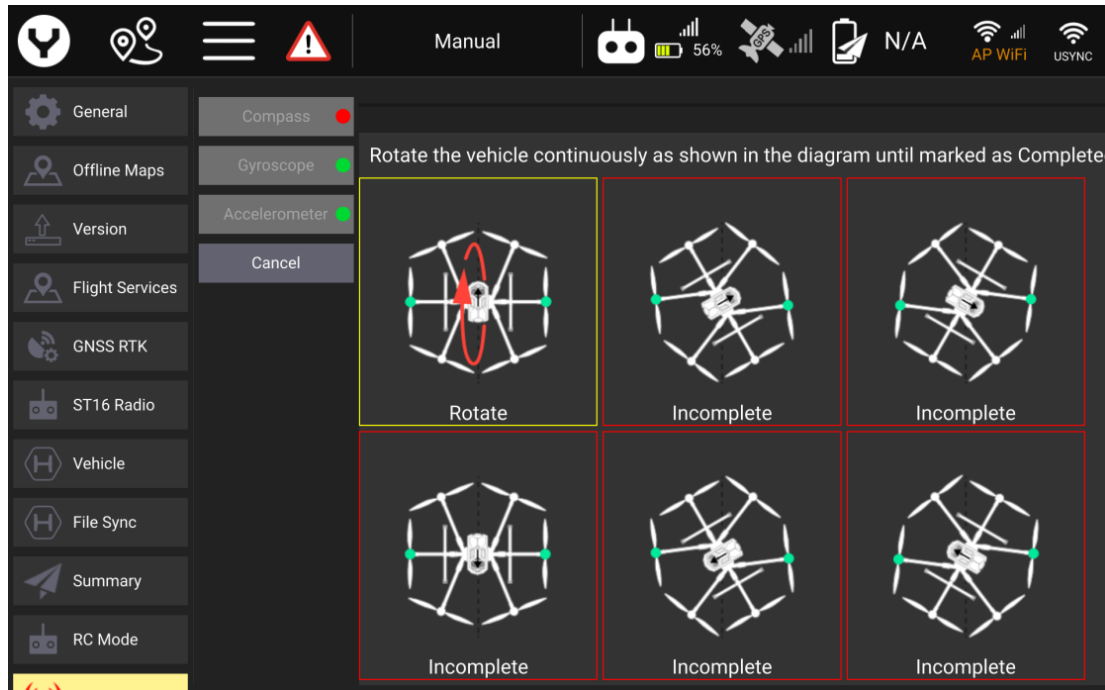

Calibration Finished for all Axis

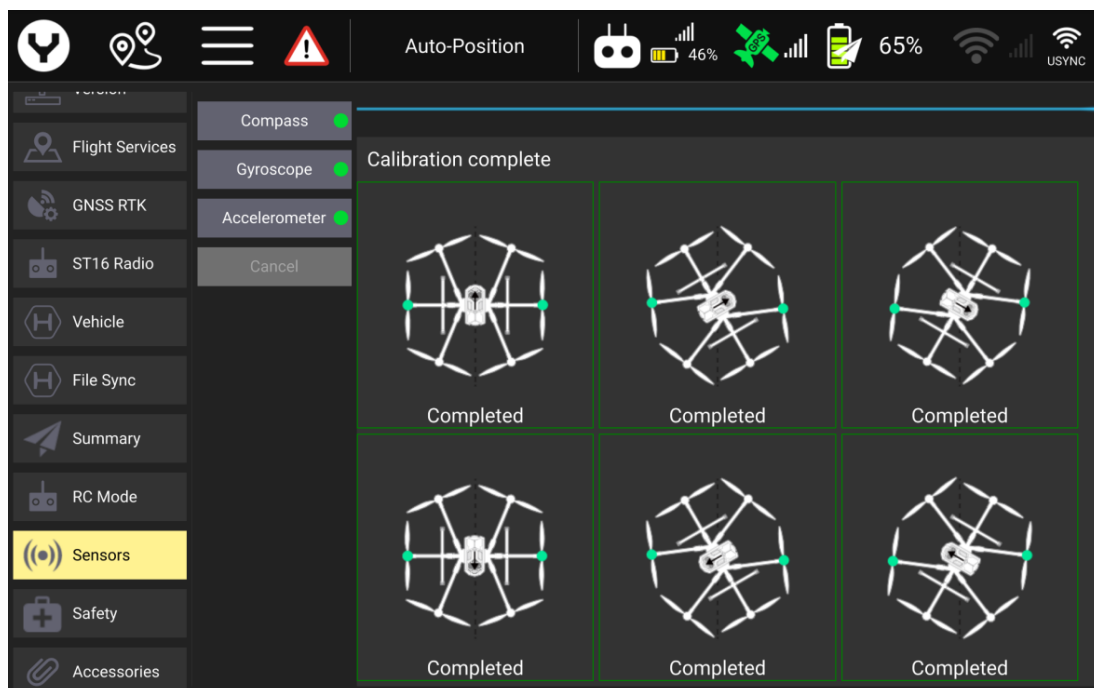

Step 4: Reboot the drone

After all axis have been calibrated, tap the **Reboot Vehicle** button on the popped-up dialogue box to activate the calibration.

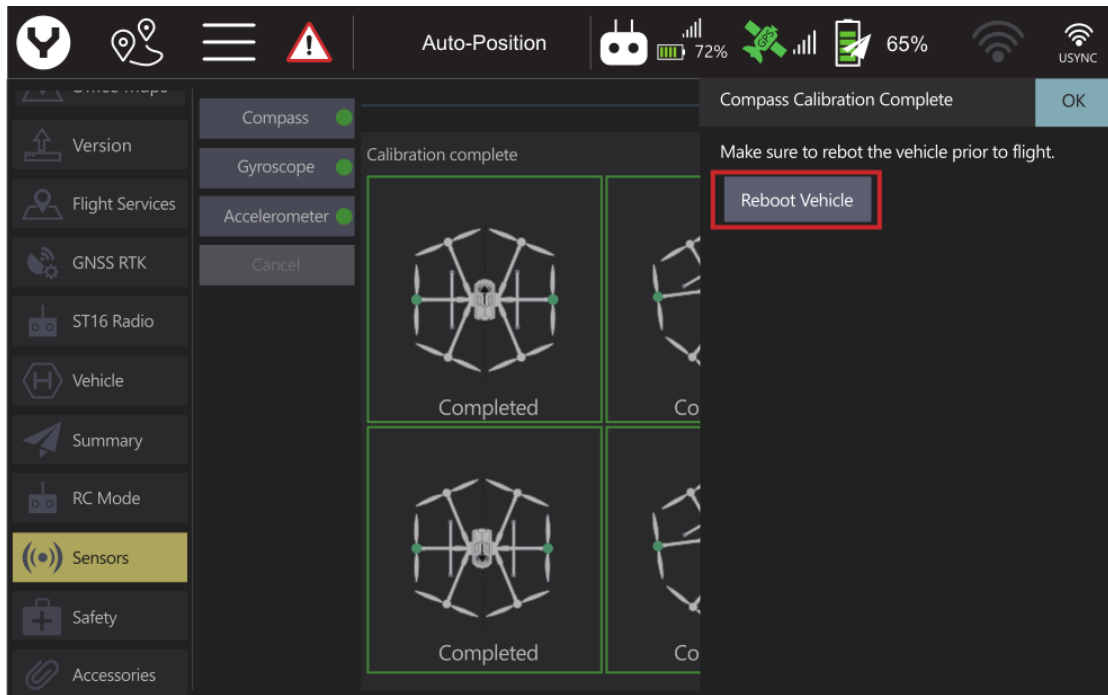

CORS Network Binding:

The Network CORS and RTK GPS have been disabled by the default setting. The H850 Drone will be positioned and navigated by using single GPS technology.

The RTCM Source was disabled by default under the GNSS RTK item.

The operator can connect the drone with the Network CORS as per the following steps to get a higher positioning accuracy.

Step 1: After the T1 Transmitter and drone are bound, tap the Wi-Fi icon and select a Hotspot to make the T1 Transmitter connect to the internet.

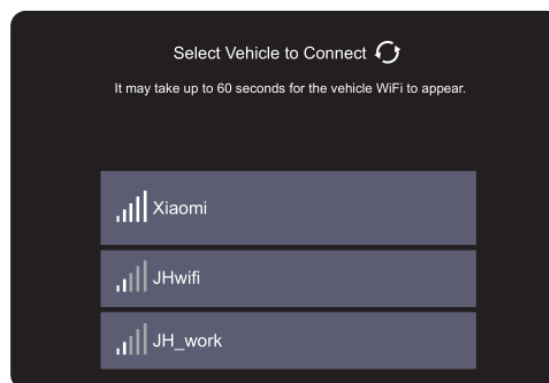
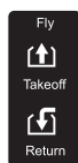

Step 2: Tap the **Settings** icon, then tap **Vehicle**. Select the RTK GPS and tick the **Enable RTK GPS** box, then restart the drone.

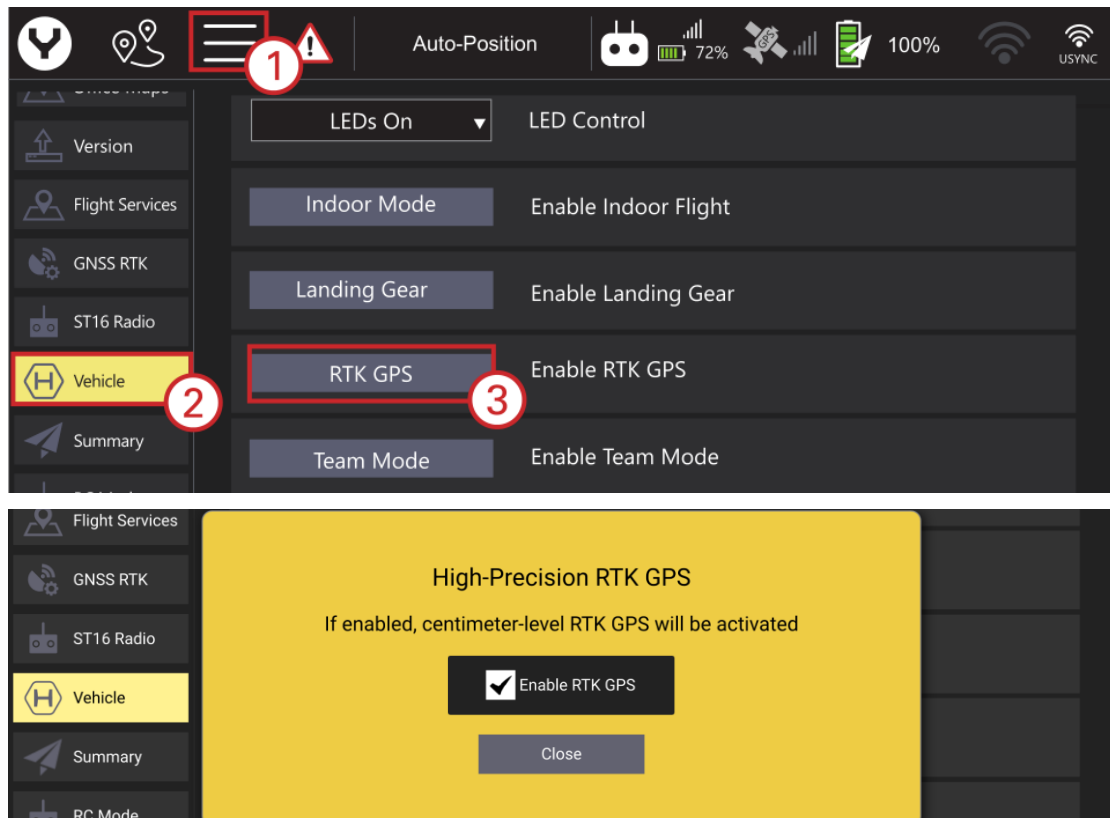

Step 3: Tap the **Settings** icon then tap **GNSS RTK**. Select **NTRIP** as the **RTCM** source, then tick **Auto Reconnect**.

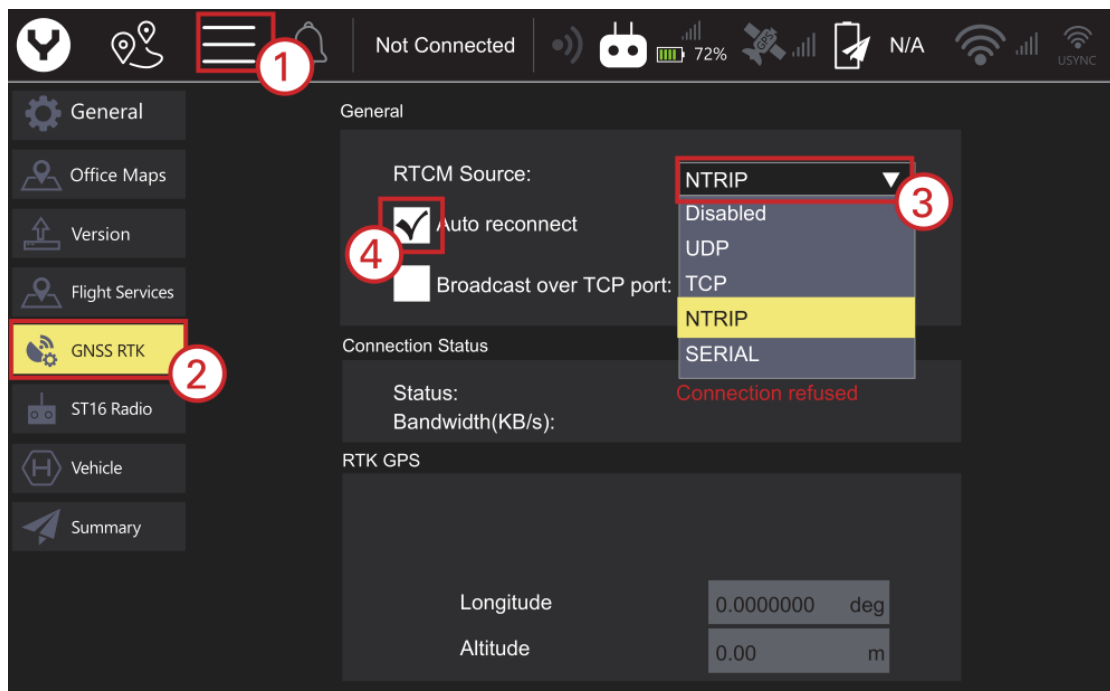

Step 4: Fill the following **NTRIP Stream Settings** parameters according to your CORS Network.

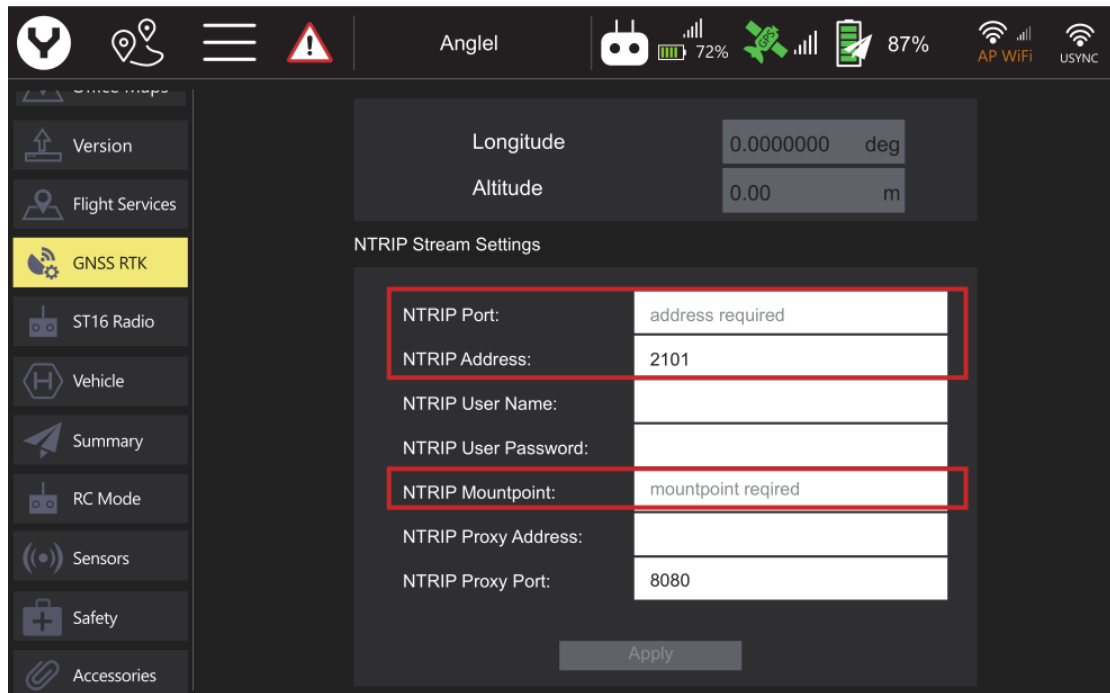

Notice: You must fill out the Required Tagging Form.

Step 5: Tap Apply button to finish the connection process.

Notice: When connected to the CORS Network has been successful, the Connection Status display will display a green "Connected".

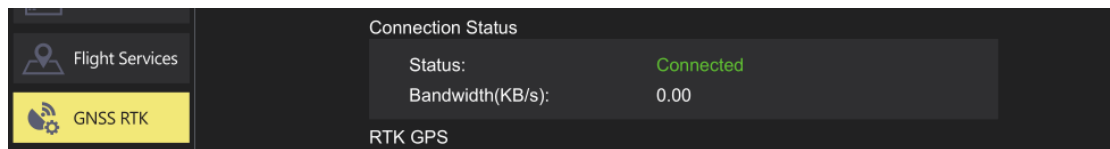

Notice: Do not enable the RTK GPS when the RTCM Source is unavailable.

Environment Requirements

Always operate the Drone in open areas (approximately 10000 square feet/930 square meters or more) that are free of people, vehicles, trees and other obstructions. Never fly near or above crowds, airports or buildings.

Never attempt to operate the drone near tall buildings/obstructions that do not offer a clear view of the sky (minimum clearance of 100°).

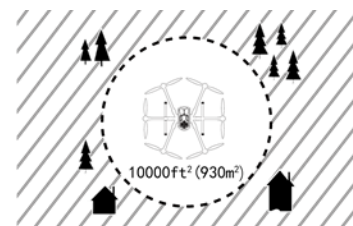
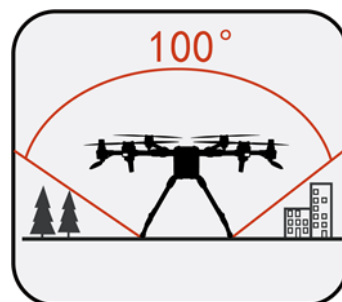

Take OFF

Unfold the propellers manually before starting the motors.

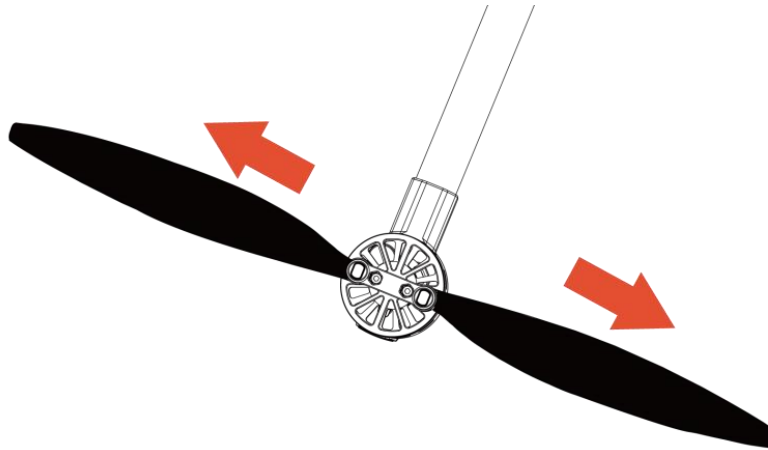

The drone has 4 different basic flight modes we suggest placing the flight switch in the middle position to use the Angel mode to take off.

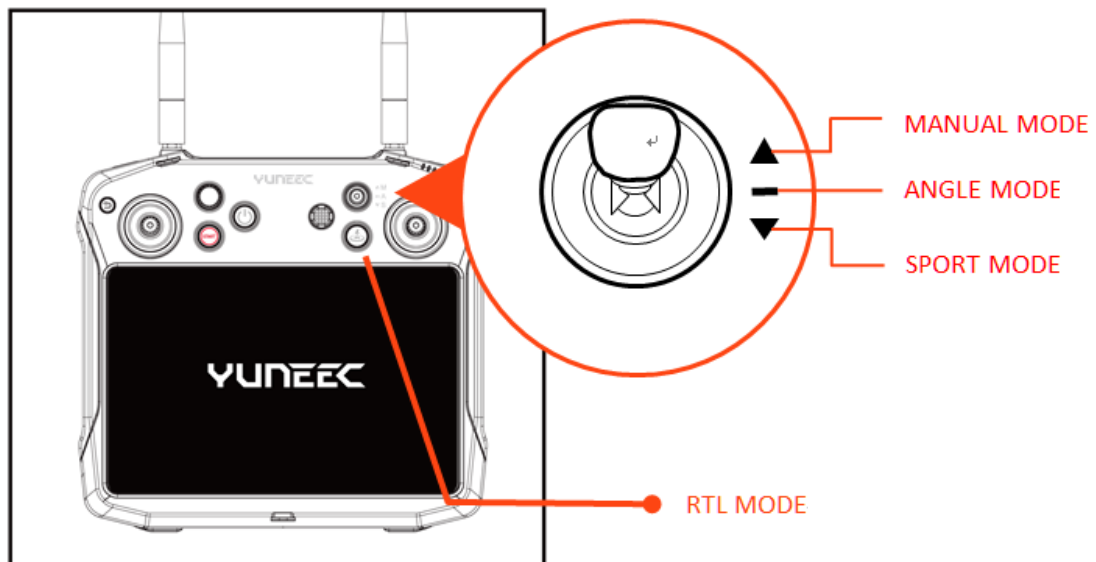

Optimal Transmission Range

The signal between the drone and the T1 Transmitter is most reliable when the antennas are positioned in relation to the drone below.

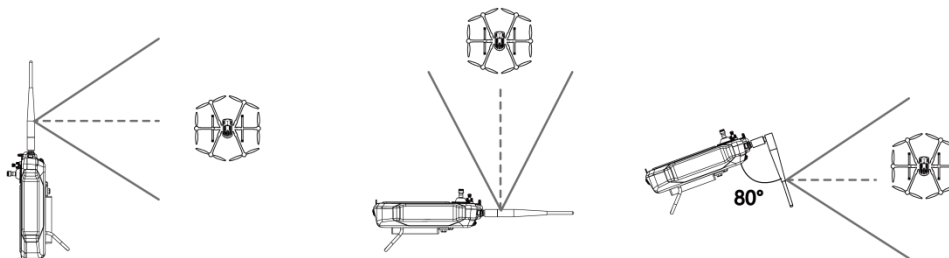

Ensure that the drone is flying within the optimal transmission range.

Take Off - OPTION 1:

After the drone we can start the motors by pressing and holding the motor Start stop button on the T-1 Transmitter and release it when the motors start.

Slowly raise the left-hand stick to take off (Mode 2 Shown).

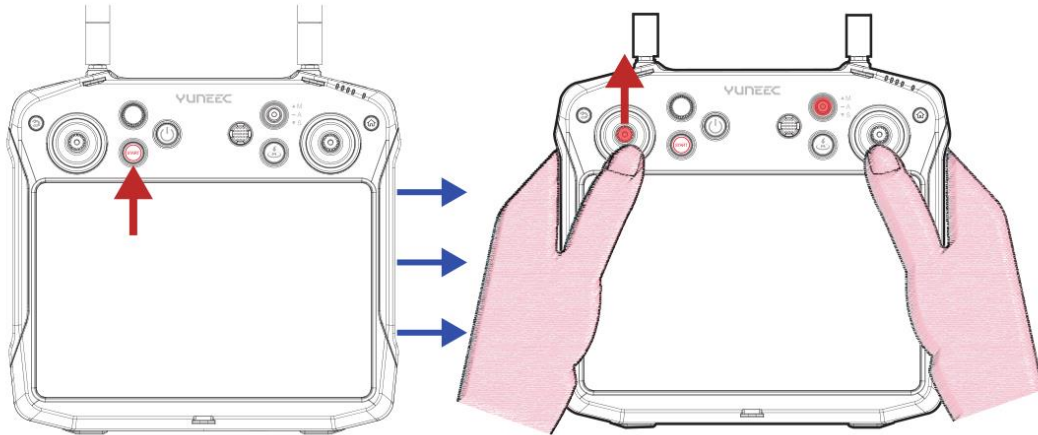

Take Off - OPTION 2:

Tap the Take Off icon and set the takeoff altitude, then slide on the screen to take off. There is also a Landing soft key beneath the takeoff soft key that may be used for Auto-Landing.

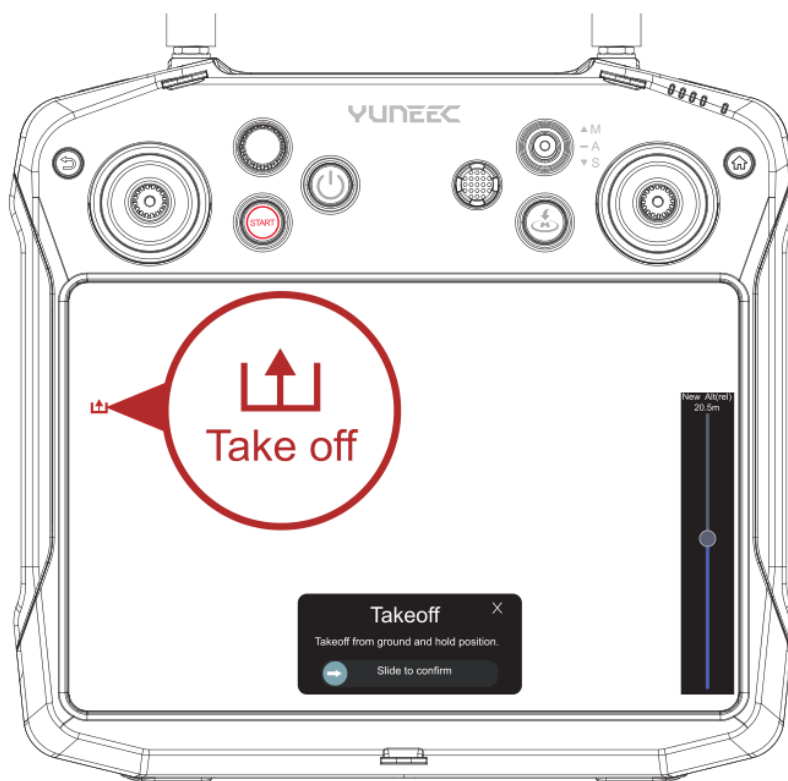

Controlling the drone

Basic Flight Control

Outdoor flight

Flight Mode Switch Overview

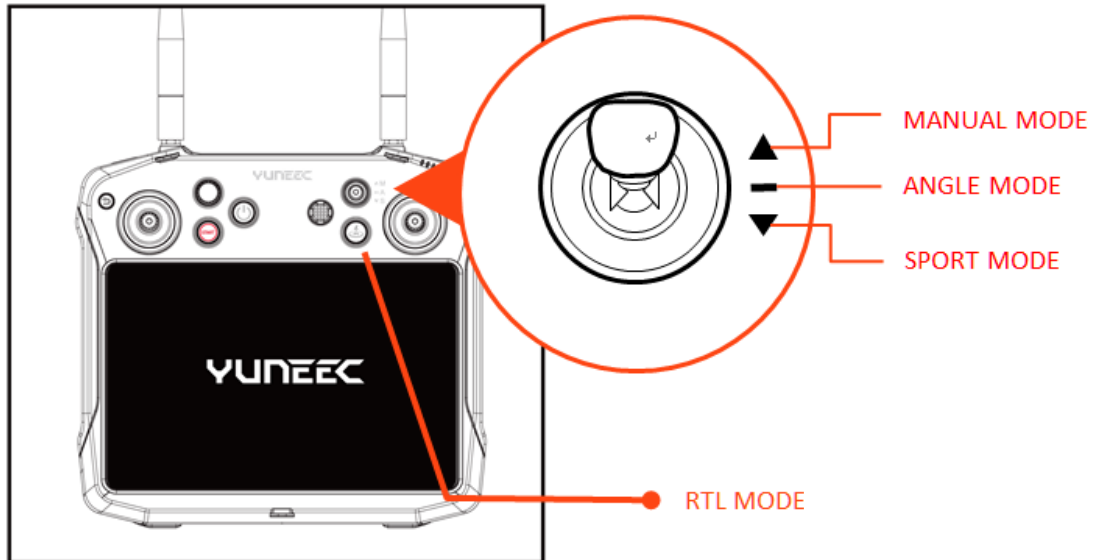

ANGLE MODE

When in Angle Mode and GPS is available, the H850 will respond according to the T-1 Transmitter.

SPORT MODE

In sport mode, the drone responses are optimised for agility and speed, making it more responsive to joystick movements.

RTL MODE

The Return to launch (RTL) function brings the drone back to the last recorded Home Point and lands automatically. To enter the RTL MODE, please press and hold the RTL Button on the T1 Transmitter after the drone takes off.

MANUAL MODE

When in Manual Mode, GPS will be deactivated.

The aircraft will only use its barometer to control the altitude positioning.

Tips: Manual mode is not recommended for first-time pilots. Without GPS, the aircraft will drift in slight winds and not maintain its

position.

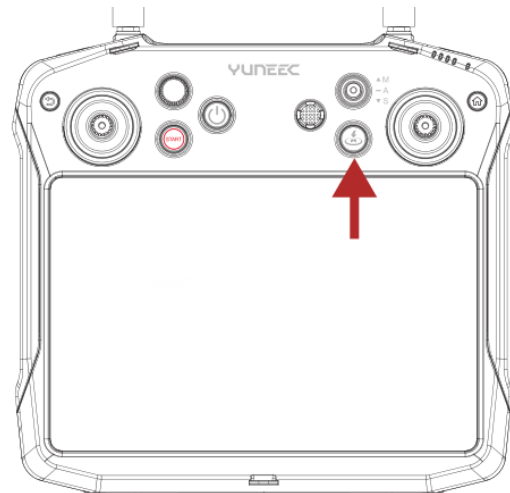
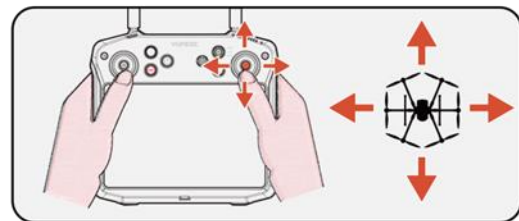
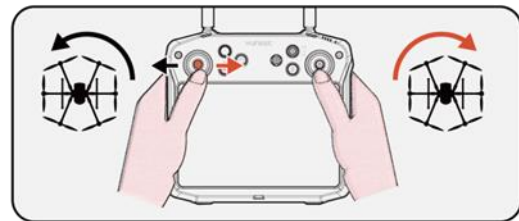

Indoor flight

When flying the drone without GPS signal, please switch to the indoor flight mode first then start the motors.

Step 1: After the drone and transmitter are connected tap the system setting button, then select the Vehicle item, and tap the Indoor Mode button.

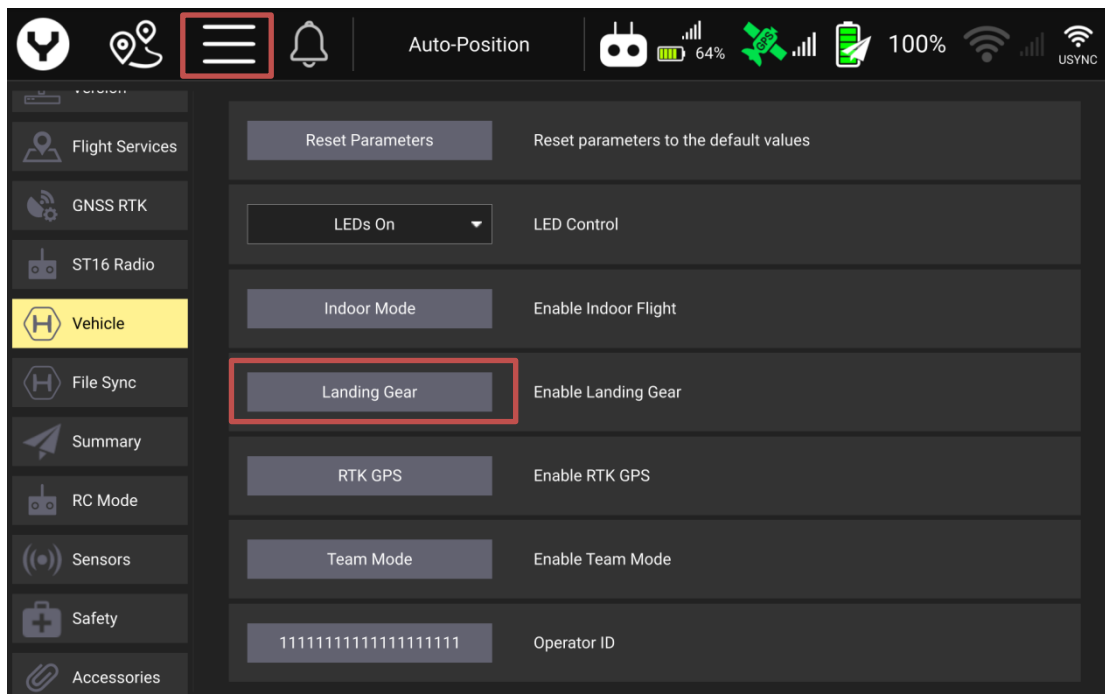

Step2: Tick the Enable Indoor Flight

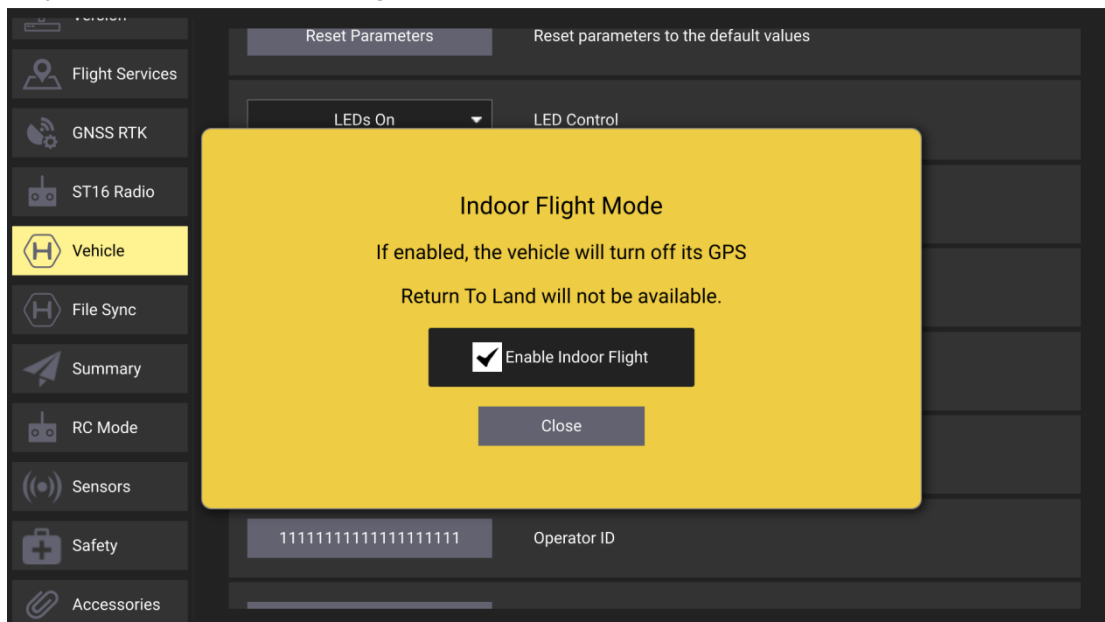

Step 3: Push the Flight Mode Selection Switch to the Manual Flight Mode, then press and hold the START/STOP button for about 3 seconds to start the motors.

Notice: Please switch back to outdoor flight mode after each indoor flight; otherwise, the drone won't get a GPS lock when flying outdoor next time.

Go to Location flight.

After the drone has taken off with GPS Lock the operator can command the drone fly to a specific point on the map by directly tapping the map.

Click the "Go to location" then the tapped point will be marked on the map as the "Go here" point.

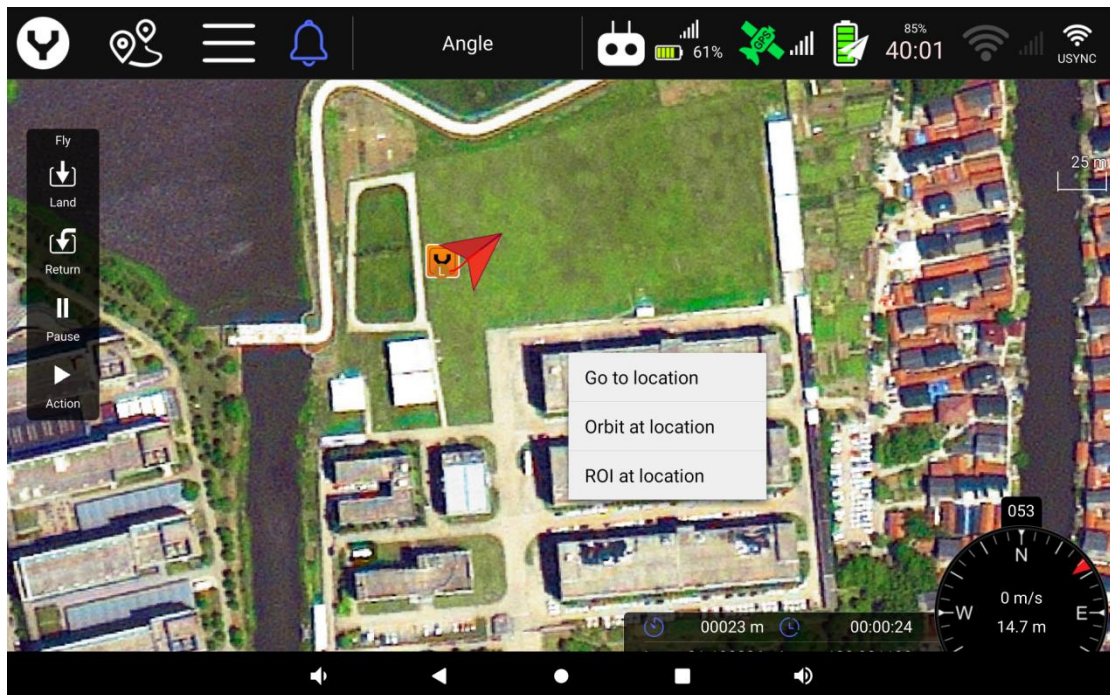

Slide the slider; the drone will fly to the Go here point on a straight flight line.

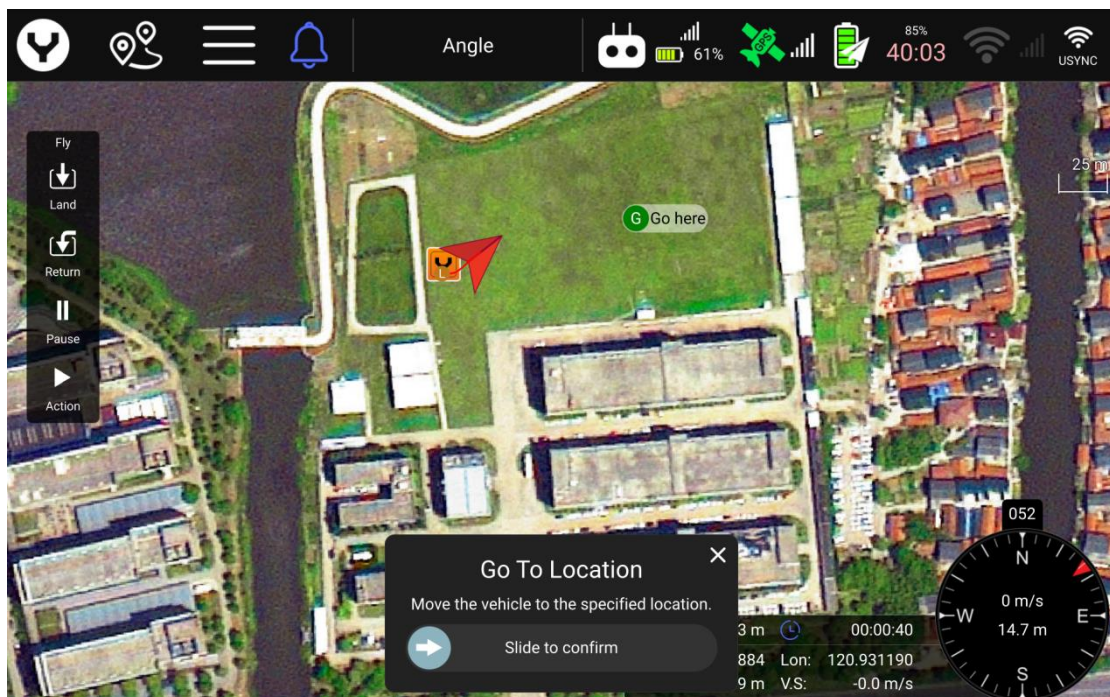

After arrival, the drone will stay hovering at the Go here point.

Notice: The operator can stop the Go to Location Mission by pushing or pulling any joystick in any direction.

Orbit Flight

After the drone has taken off with GPS Lock the operator can command the drone to fly to orbit a specific point on the map by tapping the map directly.

Tap the "Orbit at location" point then the tapped point will be marked on the map as the orbit centre point.

Orbit Flight Setting interface overview:

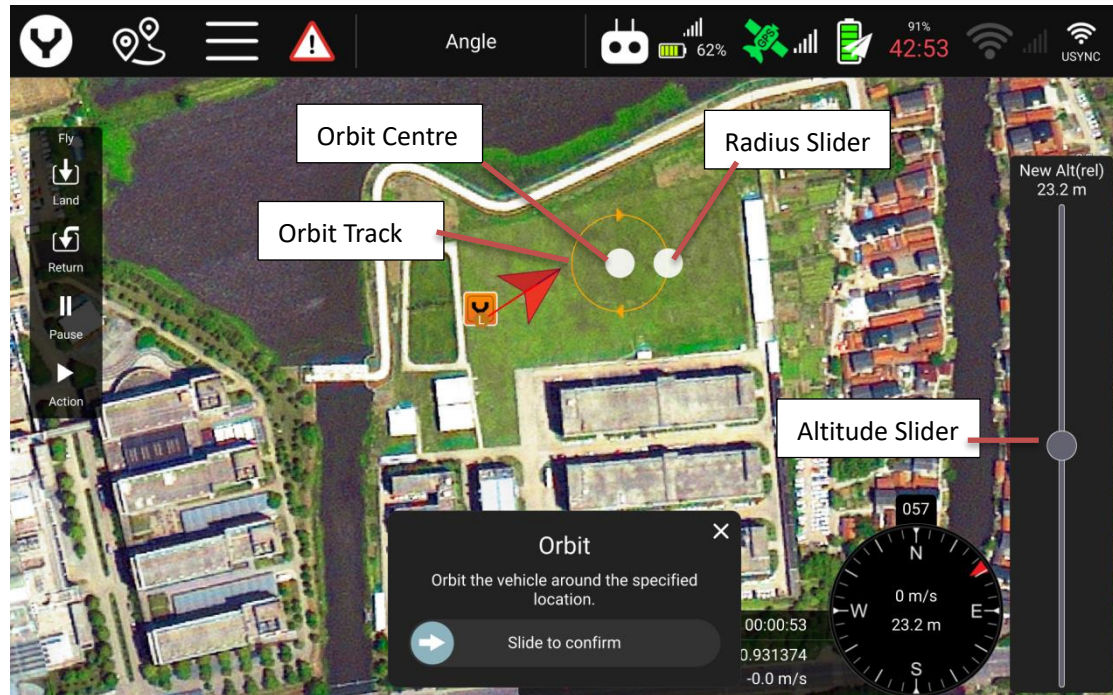

The operator can adjust the initial orbit centre and radius by dragging the white dot of the orbit centre point and the radius slider.

After the altitude is confirmed, slide the slider on the bottom to start.

Adjust the orbit speed, radius and altitude

After the orbit flight is started, operator can adjust the radius by using the elevator/pitch joystick; meanwhile, the orbit speed can be adjusted by the aileron/roll joystick when orbiting.

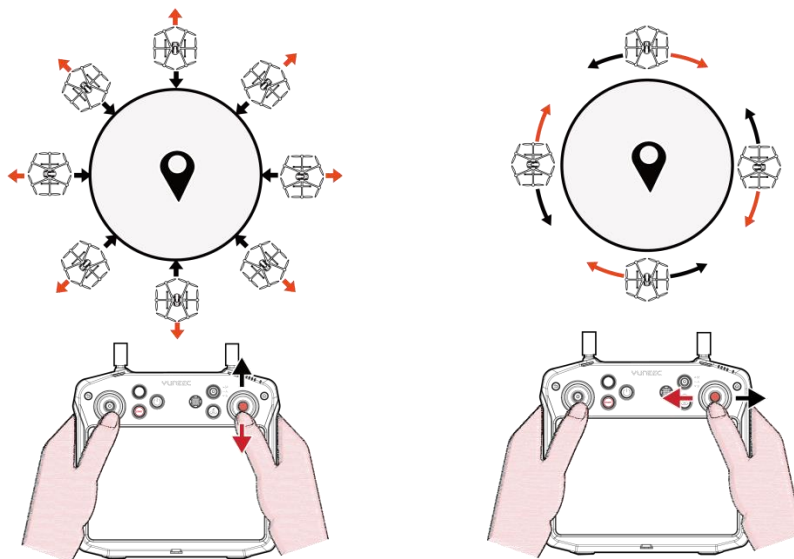

Top adjust the altitude, operators can use the throttle/altitude joystick.

ROI Flight

After the drone has taken off with GPS Lock the operator , can command the gimbal towards a specific point of interest on the map by directly tapping the map

Select the "ROI at location", then slide to confirm the tapped point will be marked on the map as the ROI point.

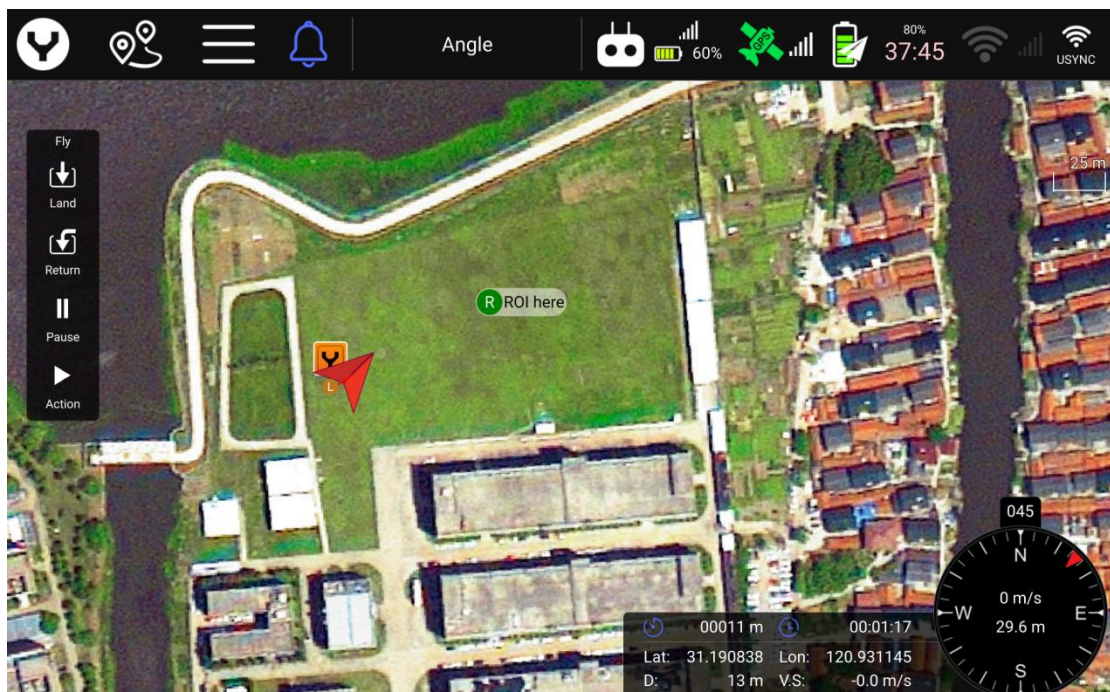
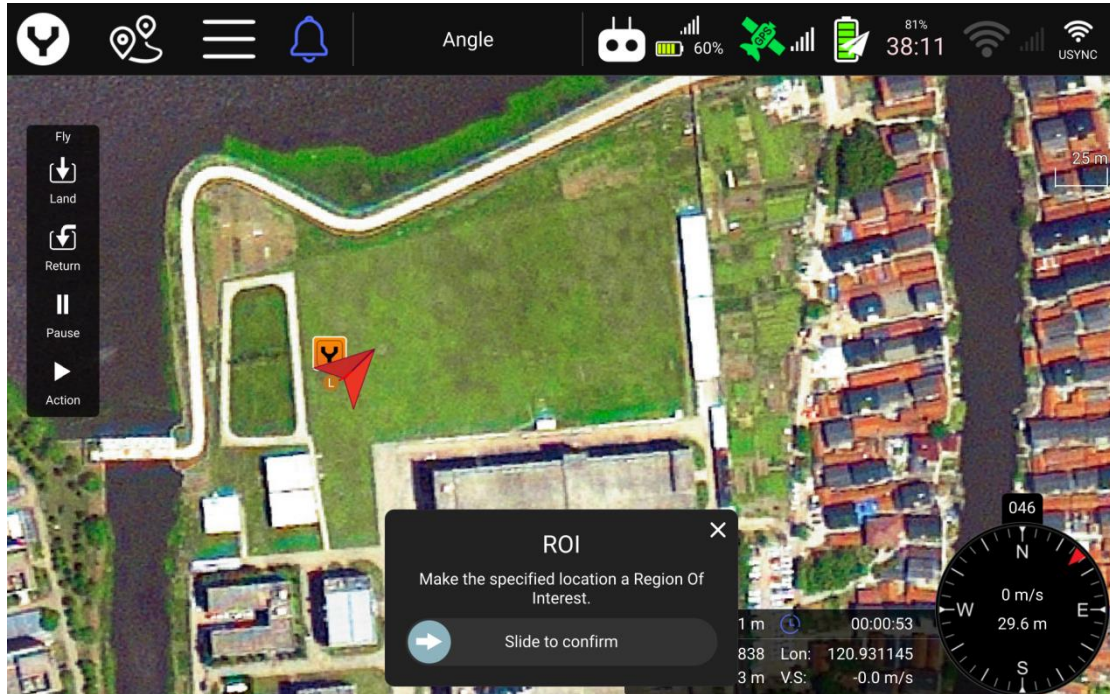

After the ROI point is set, the gimbal will turn its pan direction to look at the ROI point.

Landing

Slowly lower the throttle/altitude joystick below the centre position, H850 will descend slowly and land. After the drone lands, the motors will stop after 2 seconds without any operation.

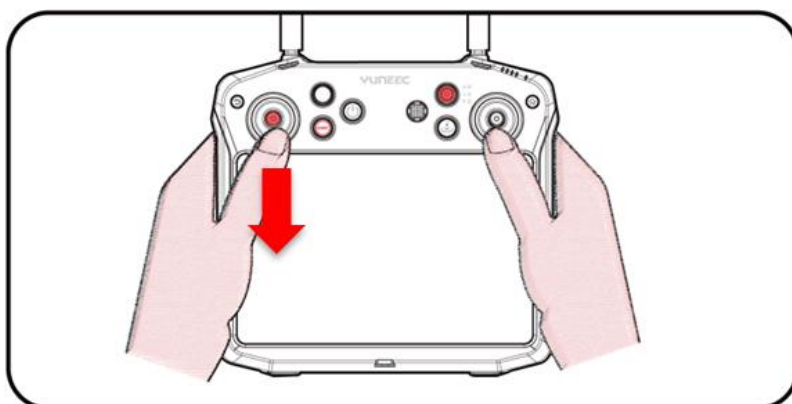

Mode 2 Shown

Emergency Motor Stop

The operator can force stop the motors by the following operation in the emergency situation such as the blades could hit the people and cause serious injury. Or the drone flies away under the loss control conditions which may be caused by a faulty sensor

To “force stop” the motors, pull the throttle joystick to the bottom, then press the Motor Start/Stop Button 3 times rapidly.

Warning: The motors will stop even if the drone is flying using the Force stop command.

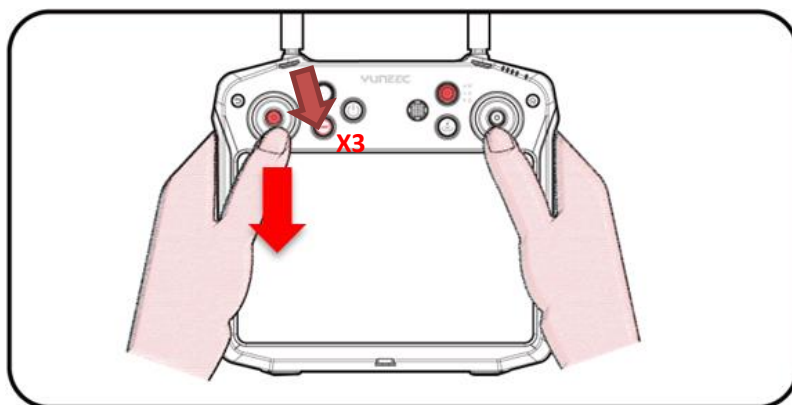

Mode 2 Shown

Notice: If the motors are force stopped, to start the motors again, the operator must first reboot the drone.

Gimbal Control

GIMBAL CAMERA TILT CONTROL

The operator can control the tilt of the gimbal by using the Tilt Control Knob.

Rotate the knob to the left to tilt down the gimbal, and Rotate the knob to the right to tilt up the gimbal.

Keep the knob at the centre point to hold the tilt angle of the gimbal.

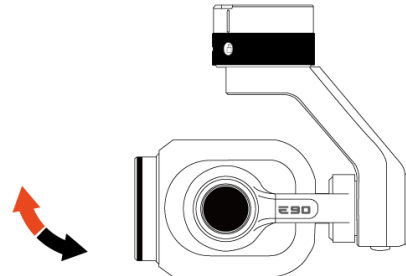
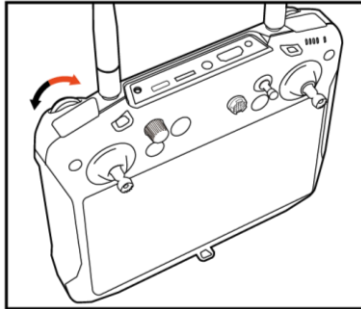

GIMBAL CAMERA PAN CONTROL

The operator can control the Pan of the gimbal by using the Pan Control Knob.

Rotate the knob to the left to pan left the gimbal, and Rotate the knob to the right to pan right the gimbal.

Keep the knob at the centre point to hold the pan direction of the gimbal.

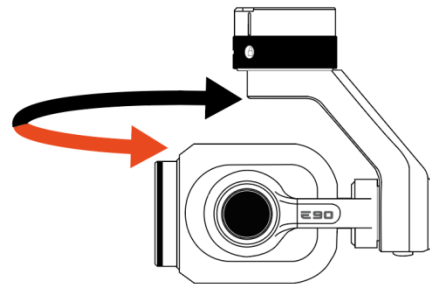
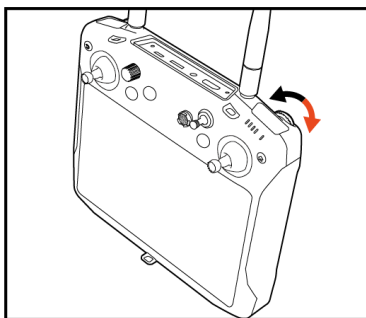

Re-Bind

The drone and T1 Transmitter are already bound before being shipped from the factory. It is unnecessary to bind them again. The pilot can follow the steps below if rebinding is needed.

Step 1: Power on the H850 Drone. Wait a few seconds for all systems to boot up.

Step 2: After initialisation completes, use a paperclip or similar item to push the bind button inside the hole as shown the picture. Release the button when the yellow LED blinks yellow.

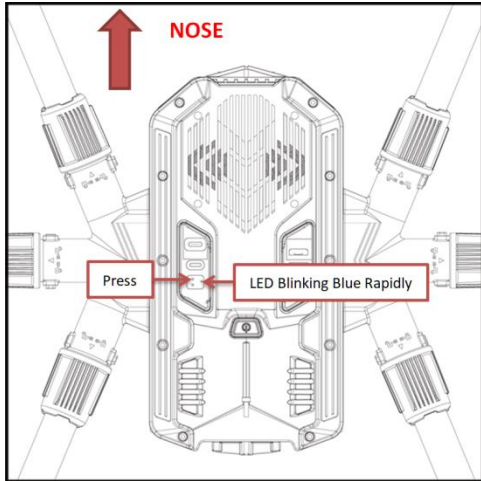

Step 3: Power on the T1 Transmitter and tap the USYNC Button to bind.

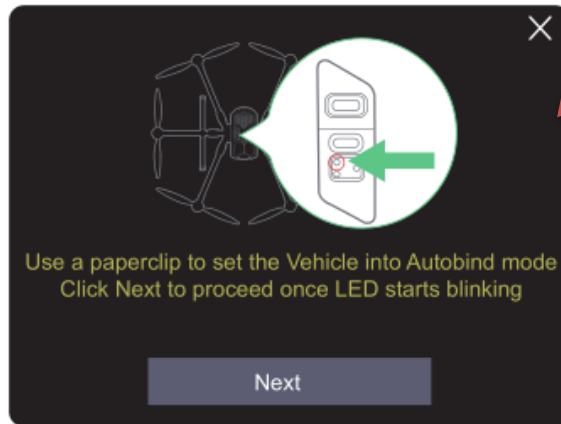
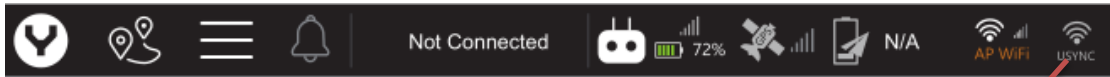

Step 4: Tap the Next Button to start the binding process.

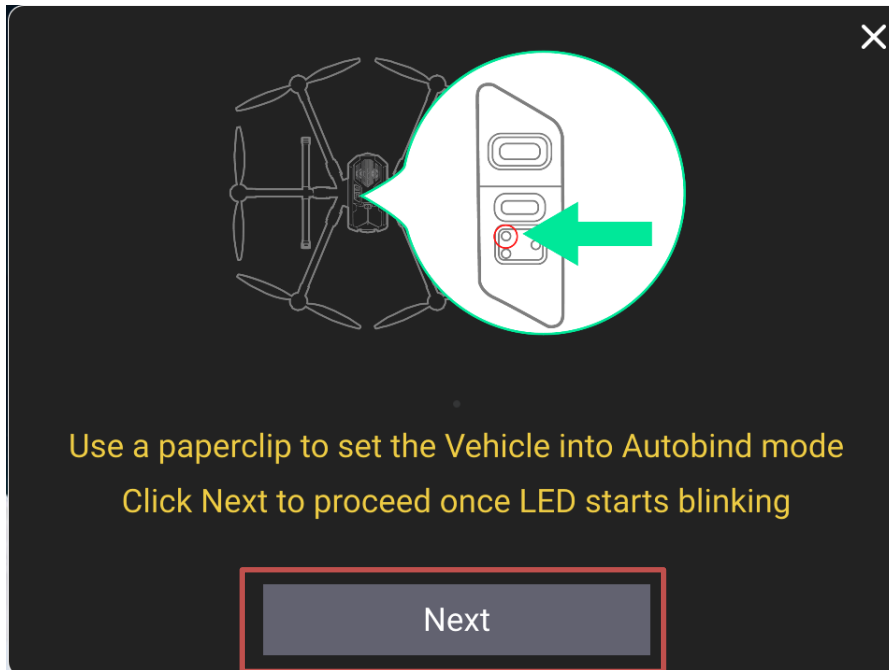

Step 5: Connecting.

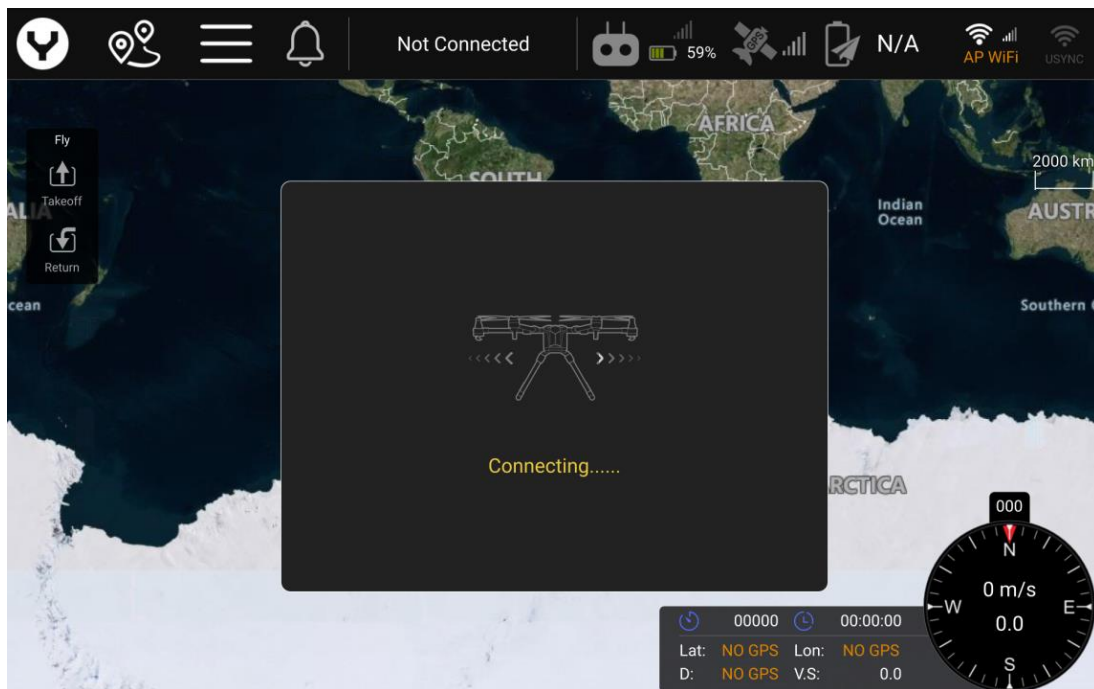

Step 6: Tap the "Finish" button to finish the binding process.

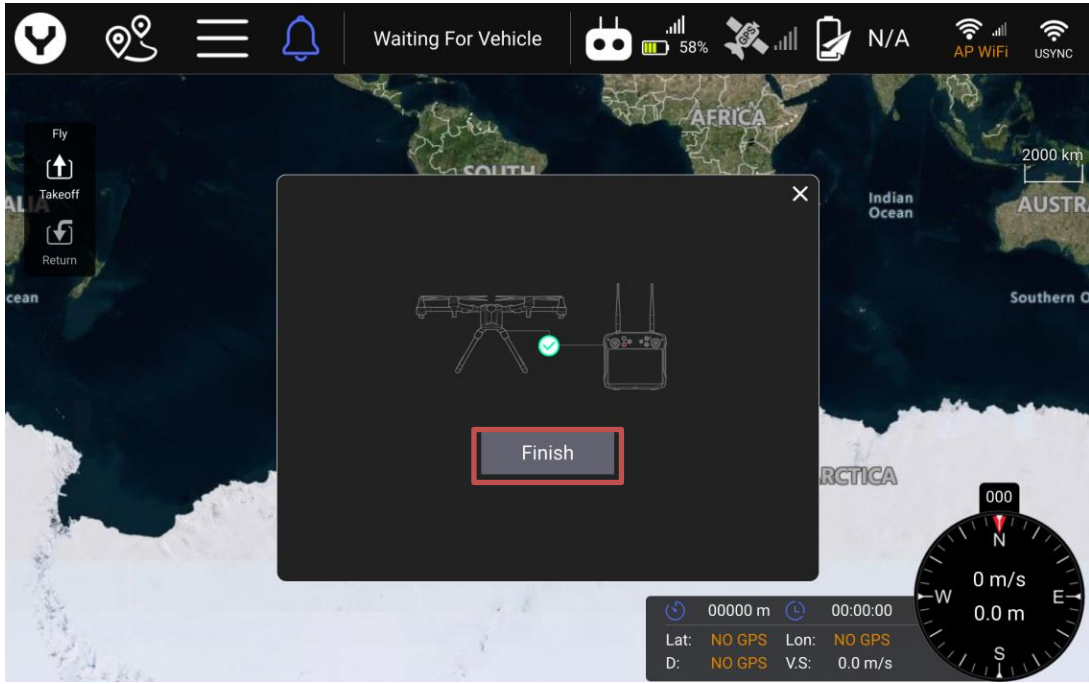

Data Pilot APP

DataPilot™ is an economical and efficient task planning software tailored for industry operators, which is preinstalled in the smart transmitter for all the YUNEEC commercial drones.

Main Interface Overview

Full-Screen Map Interface

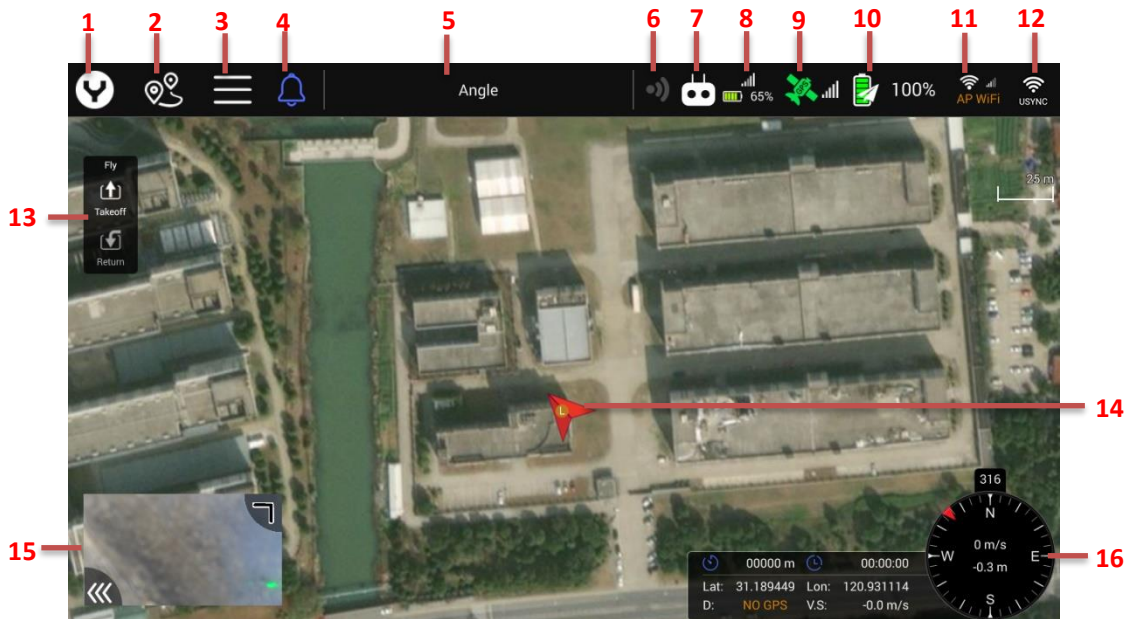

01 Main Interface Button

Return to the main interface from any other interface by tapping this button.





02 Mission Route Setting Button

Tap this button to enter the Mission Editing Interface.

03 Settings button

Tap this button to open the extended menu to view and adjust the parameters of other settings.

04 Warning Message button

After the Warning Message released by the drone, the bell icon  will change to the Exclamation mark.  To view the Warning Message, please tap the Exclamation mark, then the Warning Message Window will likepop open as shown below. Tap the close button  to close the Warning Message Window. Tap the Trash can icon  to clean the Warning Messages.

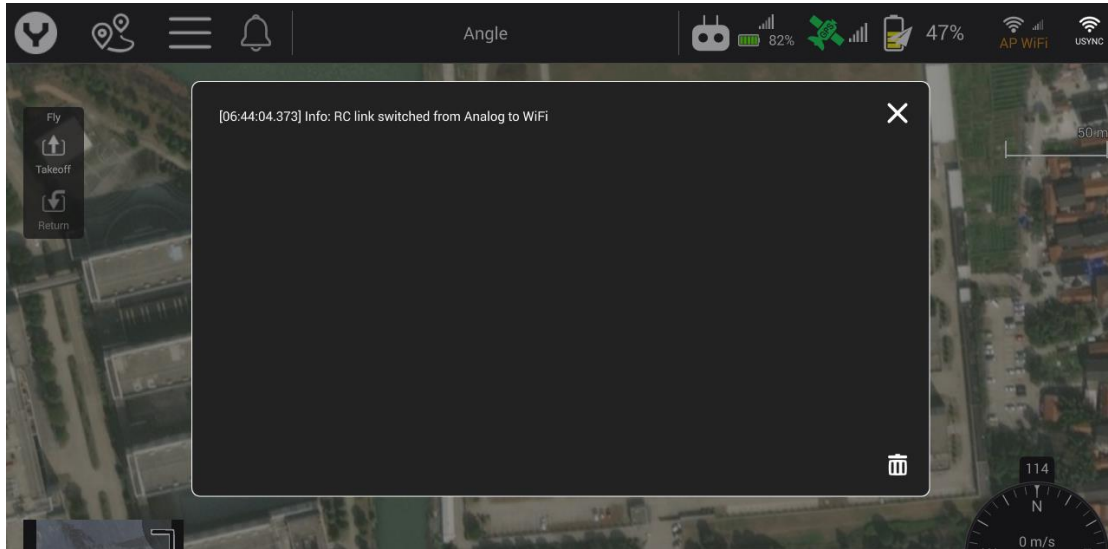

05 Flight Modes Indicator

Display the current Flight Mode of the drone.

06 Obstacle Avoidance Indicator

After the Obstacle Avoidance is switched on, this icon will turn green to remind the operator this function is enabled.

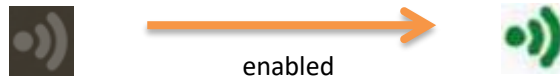

Note: For the drones without the Obstacle Avoidance function, this indicator will be hidden.

07 Communication status indicator

This indicator shows 3 different communication statuses, as in the picture shown below



Gray: The drone doesn't connect to the transmitter.



Red Flashing: The receiver already connected to the drone, and the DataPilot™ 2.0 App is attempting to establish the communication with the Autopilot in the drone.



White: The communication between the DataPilot™ 2.0 App with the Autopilot was established.

08 Transmitter Battery & RSSI

This icon displays the Remaining Battery Power and acts as the RSSI (Received Signal Strength Indication) of the transmitter.

Tap this icon to display more information of the transmitter status.

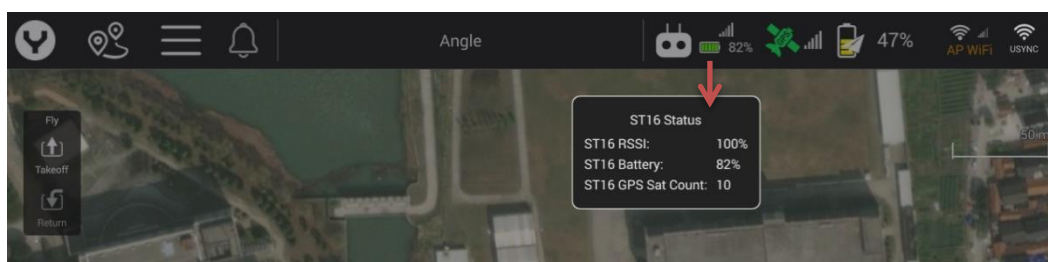

To close the dialog box, just tap other areas on the screen.

09 Drone GPS indicator

This icon displays the Drone GPS status. When the icon turns green it means the drone has an ideal positioning accuracy for flight.

Tap this icon to display more information of the drones GPS status.

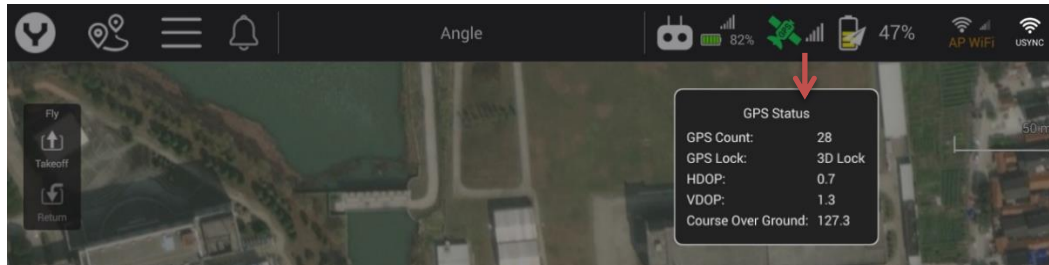

To close the dialog box, just tap other areas on the screen.

10 Drone Battery indicator

This icon displays the Remaining Power and percentage of the drone flight battery.

Tap this icon to display more information of the drone battery status.

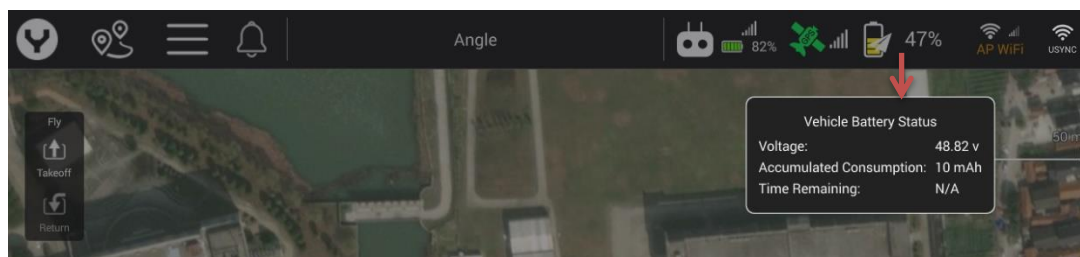

To close the dialog box, just tap other areas on the screen.

11 Wi-Fi RSSI & Setting button

This icon displays the Wi-Fi RSSI. The operators can also open the Wi-Fi Setting Menu by tapping this icon.

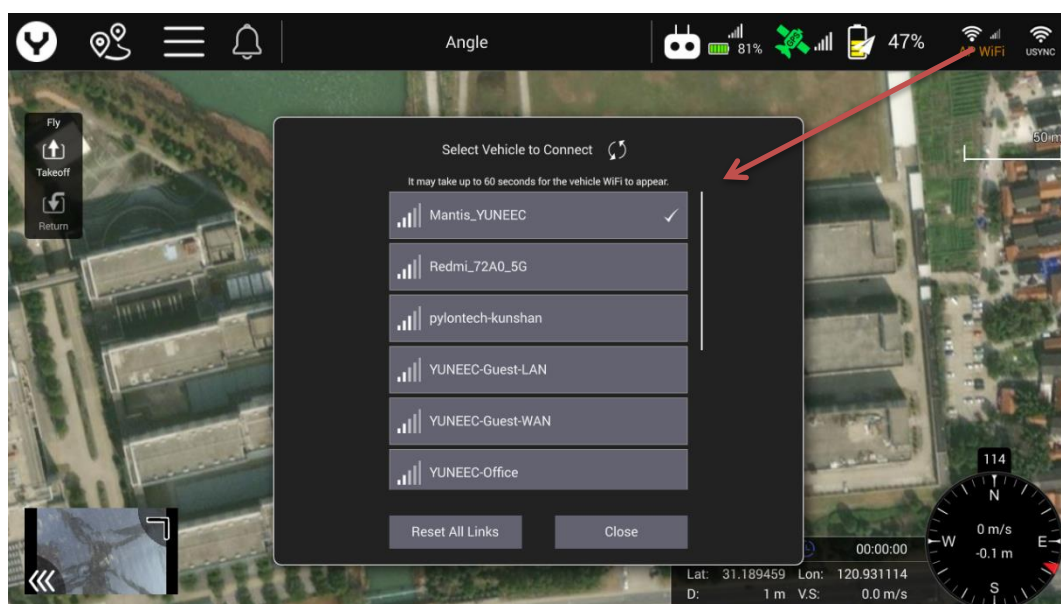

The operator can select, refresh, connect or reset the available Wi-Fi hotspot under the Wi-Fi Setting Menu.

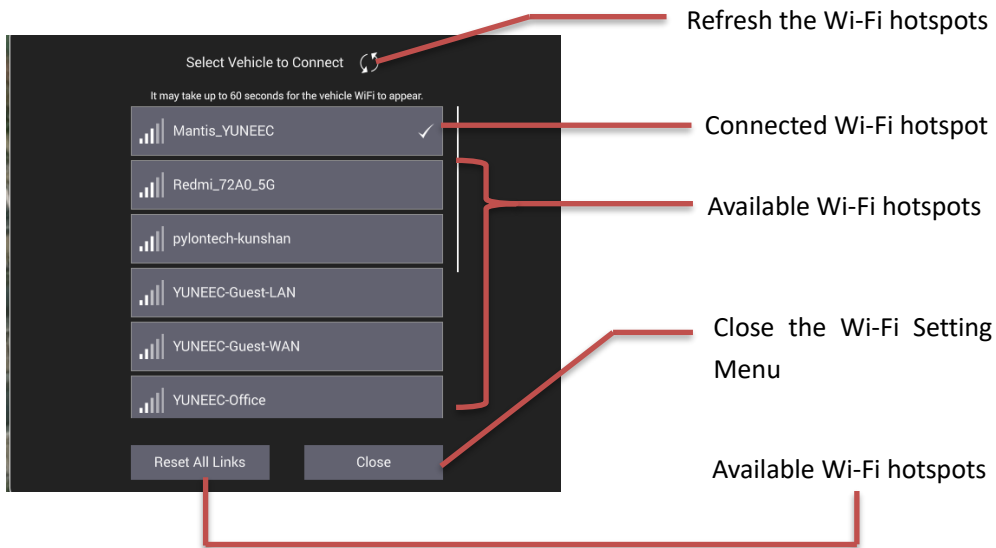

The operator can select the Wi-Fi hotspot wanted by tapping the SSID in the available Wi-Fi hotspot list, and then enter the passwords to connect.

Once the Internet is connected, the operator can download the electronic map, get the Network CORS source or action other operations.

12 OFDM RSSI & Setting button

This Icon displays the OFDM RSSI. The operator can also open the OFDM Menu by tapping this icon for Binding or Unbinding.

13 Flight quick control panel

The operator can set the control command by using this panel. After the drone takes off the panel will add 2 items as per the screenshot below:

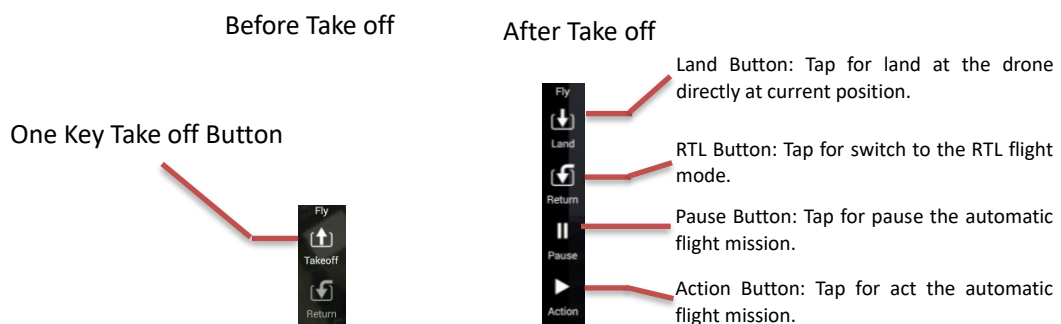



14 Drone

Indicate the drone position and course. The L point  means the Launch point of the drone.

15 Map /Video Switch

Display the thumbnail window of the map or Video link feedback. Tap to view the full screen map or Video interface.

The operator can tap the hide icon  to hide the thumbnail window, or drag the  icon to adjust the size of the window.



16 Flight Data Panel

Indicate the flight data

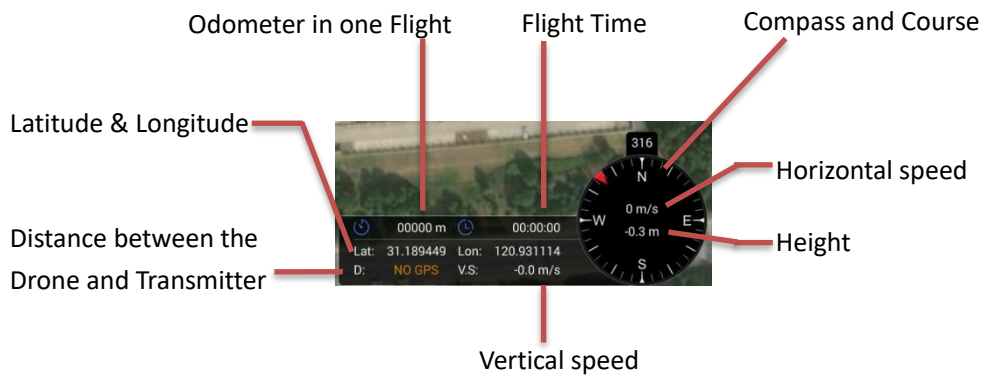

The operator can hide the panel left to the compass by single tapping the compass dial.

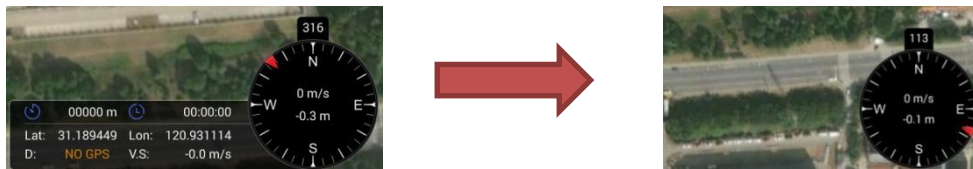

The Compass also can be switched to the gyroscopic horizon dial by tapping the dial in quick succession.



The Height and Horizontal Speed data will also be moved to the panel left to the dial.

Video Link Interface

After The Main Screen has been switched to the Video Link feedback interface, the operator will get the screen shown below:

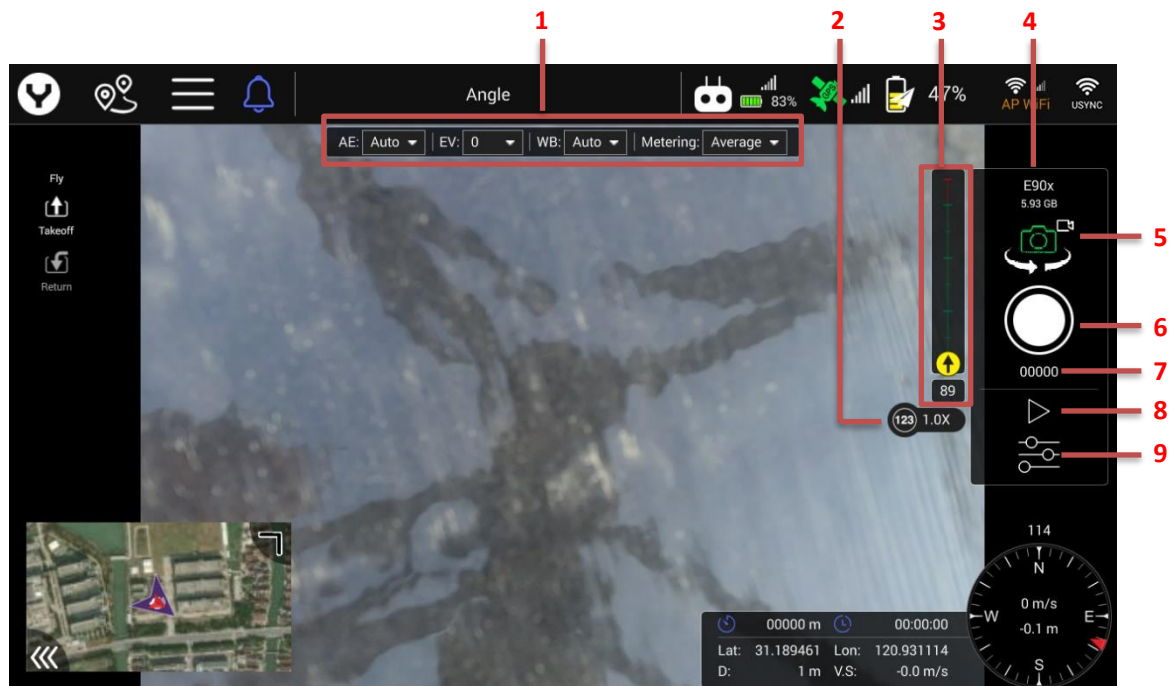

1 Camera quick access menu

The operator can adjust the camera parameter quickly by using this menu. Such as exposure mode, white balance, etc.

Note: According to different camera type and parameter setting this menu could change.

2 Zoom Icon

This icon displays the zoom ratio of the camera

Note: According to different camera types this icon could change.

3 Gimbal attitude display

The Position of the Yellow dot  in the gimbal tilt indicator bar shows the gimbal tilt attitude.

The red marks in the bar shows the gimbal is tilted up meanwhile the green marks shows the gimbal is tilted down. For further accuracy, we can read the gimbal tilt angle in the rectangle under the Vertical bar.

There is also a black arrow in the Yellow dot which shows which direction the gimbal lens is pointing to. When the arrow is straight up it shows the gimbal lens is pointing to the front of the drone.

4 Camera Type and SD card remaining capacity

Display the camera type and SD card remaining capacity.

5 Photo/Video Mode Switch

Switch the Camera mode between the Photo mode with the Video recording mode. Just tap the Icon to switch the Camera work mode.



Camera in video mode



Camera in Photo mode

6 Shutter/Record button

In the Video Recording mode the icon is a red dot. Tap it to start recording the video and tap again to stop recording.

In the Single Photo mode the icon is a white dot. Tap it to capture a photo

In the Time Lapse Photo mode the icon is a white dot with time interval shown in the centre. Tap it to start the time interval shooting and tap again to stop.

If the SD card is full or the camera without an SD card the icon is a gray dot that means you cannot record anything.

Five different status of the Shutter or Start/Stop recording soft button



Tap to start
Recording video



Tap to Record
one photo



Tap to start time
interval shooting



Tap to stop the
Video recording
or time interval
shooting



No SD card or
SD Card full

7 Counter in photo mode/ Timer in video mode

In the photo mode the counter shows how many photos you have recorded within a single power on time .Once you have powered off the drone the counter number will be reset.

In the video mode the timer shows the time you have recorded in each single video shoot.

8 Gallery

The main function of Gallery preview enables operators to check the pictures and videos taken on the remote control, without pulling out the SD card in the camera. It offer the ability to check the quality of its own aerial photos without landing, so that operator can quickly reshoot the unsatisfactory photos or videos, greatly improving the efficiency of taking aerial photos.

The photos or videos also can be deleted in the gallery function to save the storage capacity of the Remote Controller.

Note: When deleting in the Gallery, the device will only delete the file in the Remote Controller, you won't delete them in the Micro SD card which is inserted in the Gimbal Camera.

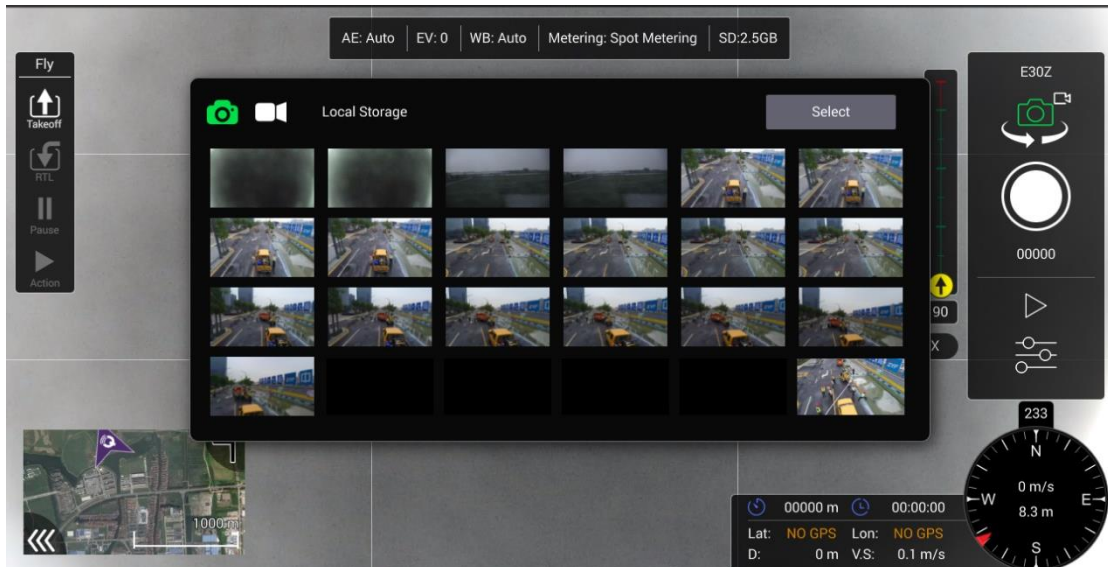

9 Camera Setting Button

Tap this button to open the camera menu for further settings.

Note: According to different camera types the camera setting menu change.

Please refer to the corresponding chapter of the gimbal manual for the camera setting menu instruction in detail.

Mission flight mode

To enter Mission planning mode, tap the Mission Route Setting icon[] on the top of the DataPilot™ home screen. The PLAN window will open, allowing the operator to create Waypoint and Survey missions, sync missions between desktop, T1 ????, and the drone, store/recall missions, and Centre a mission around a particular point on the T1 ???screen.

Waypoint

A waypoint defines a specific location and behavior at a specific point in time, allowing for intelligent auto-functions during flight. Waypoint flight is ideal for capturing oblique images, perimeter monitoring, and many other uses.

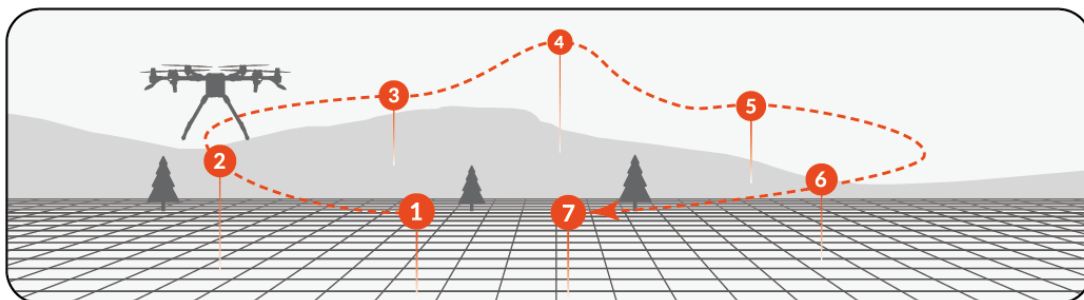

Add Waypoints

If the operator needs to plan a flight mission in a new area, connect the transmitter to the internet via a Wi-Fi hotspot to download maps

After entered the Mission planning mode, select a Blank plan and tap the Takeoff icon on the left side of the screen. If the Transmitter doesn't connected to the drone or the drone doesn't have GPS lock the operator needs to tap on the map to set the takeoff point position manually.

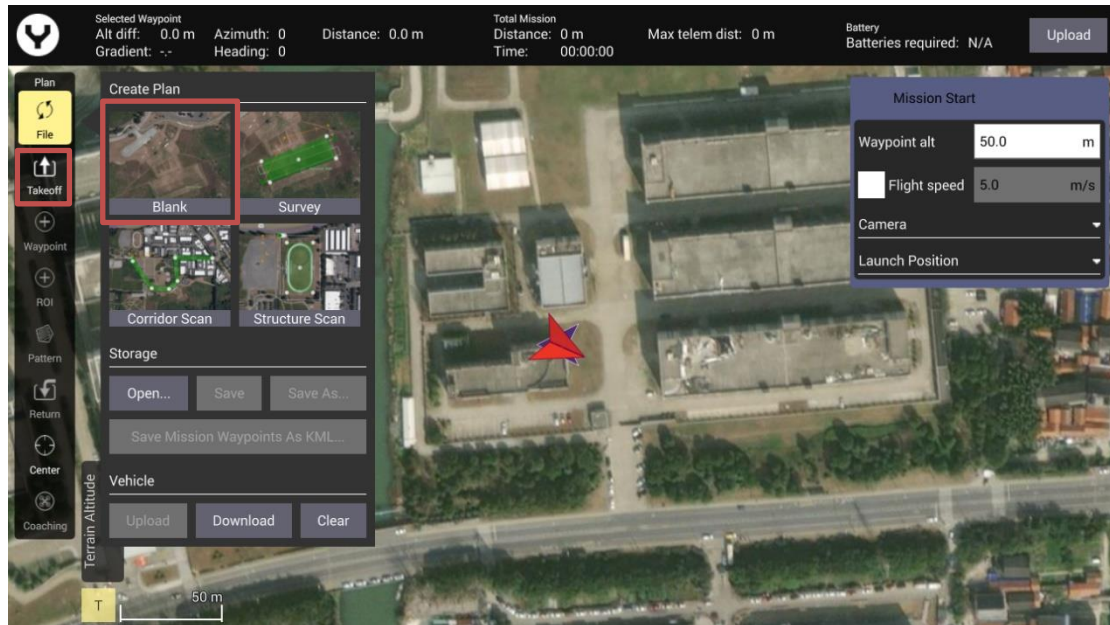

Once the Takeoff point has been set, the waypoint can be added. Tap the Waypoint icon first then tap on the map directly to set the waypoint position.

After the waypoints were added they will be shown on the screen as the picture below.

Waypoint Operator Interface Over view



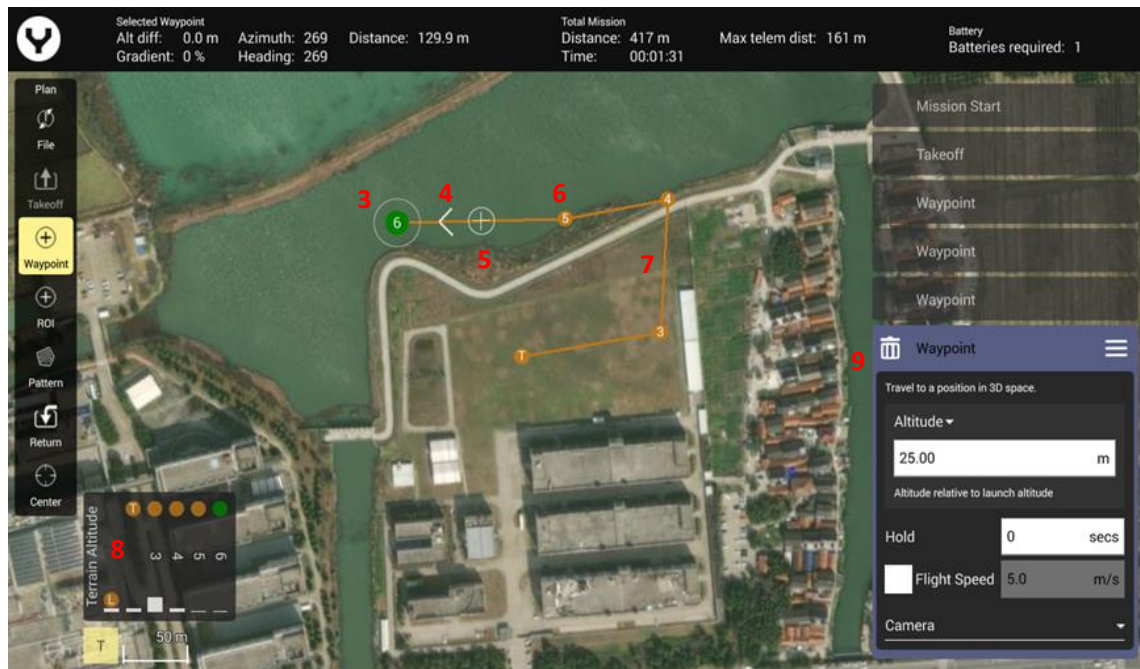

1 Selected Waypoint Parameters

Display the parameters of the selected waypoint.

2 Mission Summary

Display the Summary of the entire flight mission added to this map.

3 Selected Waypoint

When a waypoint was selected, it will be marked colour in “Green”

4 Ahead Direction Indicator

This white arrow shows the forward direction of the drone along the flight route.

5 Insert Button

Tap to insert a waypoint before the selected one on the flight route.

6 Other Waypoint

Other unselected waypoints on the flight route.

7 Flight Route

The Flight Route of this Mission

8 Terrain Altitude Indicator

This window displays the Terrain Altitude and Waypoint Altitude for mission planning.



9 Waypoint Setting Panel

This panel is the setting panel for each waypoint to adjust the waypoint parameters in detail.

Adjusting the waypoint parameters

Once a waypoint was set and selected, the screen will pop up the 'Way point Setting Panel' on the right side. In this panel almost every parameter of a waypoint can be set freely, such as Altitude, Flight speed, Hold Time, etc. Even the direction of the gimbal and the camera behaviors are included.

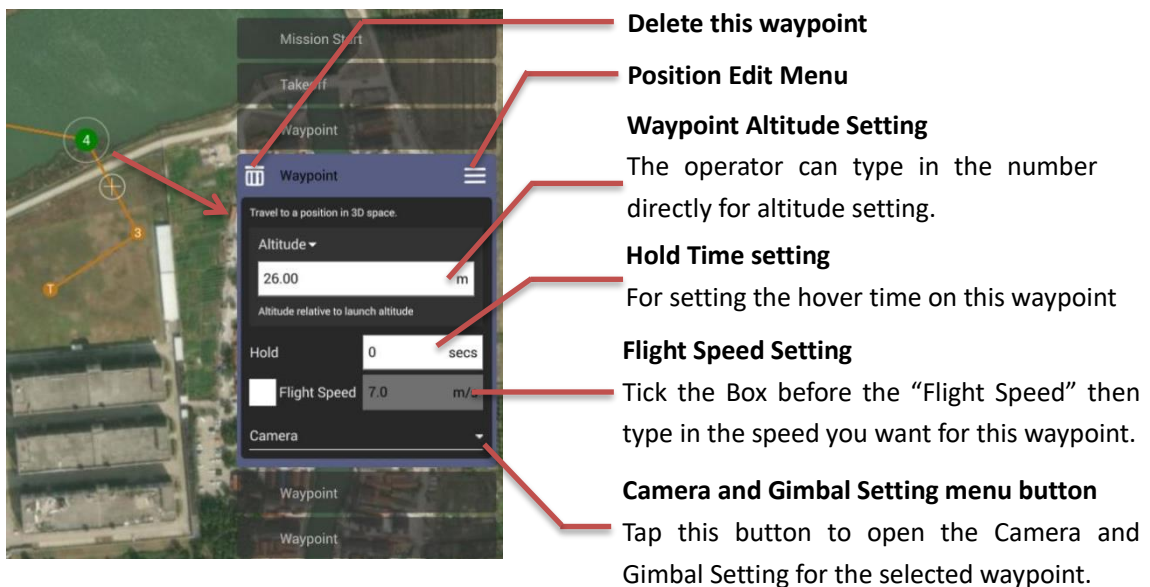

After the Camera and gimbal setting menu was opened



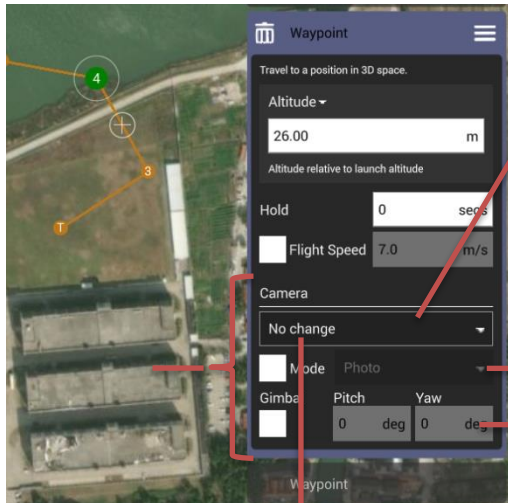

Camera Behavior Setting Menu

Tap to open the Drop-down menu for Camera behavior setting for the selected waypoint.

Camera Mode Setting Menu

Tick the Box before the “Mode” then tap to open the Drop-down menu for Camera mode setting for the selected waypoint.

Gimbal Attitude Setting

Tick the Box under the “Gimbal” then type in the Pitch and Yaw data to set the gimbal attitude for the selected waypoint.

Camera Behavior Setting Menu Instructions

- No Change – Camera maintains its current mode/settings.
- Take Photo – Captures a photo at the current position.
- Take Photos (Time) – Captures photos over a set time interval.
- Take Photos (Distance) – Captures photos over a set travel distance.
- Stop Taking Photos – Stops the camera from taking photos.
- Start Recording Video – Begins video recording.
- Stop Recording Video – Stops video recording.

Gimbal Attitude Setting Instructions

Gimbal - Adjust the camera pitch and yaw at the currently selected Waypoint. To adjust pitch, select a value between 0 (flat to the ground) and 90 (straight down).
 To adjust the yaw select a value between -180° (left of the airframe centre line) and 180° (right of the airframe centre line).

Position Edit Menu

There is a Position Edit Menu for each waypoint. To open this menu, please tap the setting icon  at the upper right corner of the Waypoint Setting Panel for the selected waypoint.

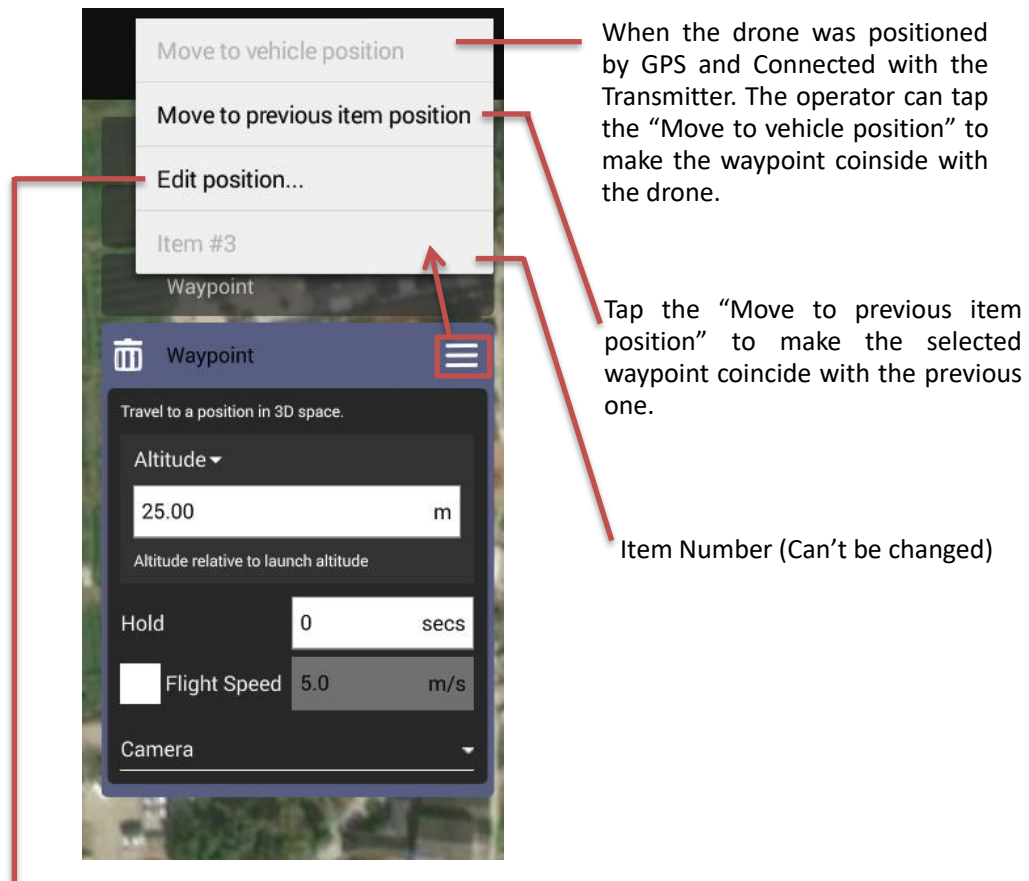

Tap the “Edit position” button to open the coordinate input menu as shown below to adjust the waypoint position precisely.

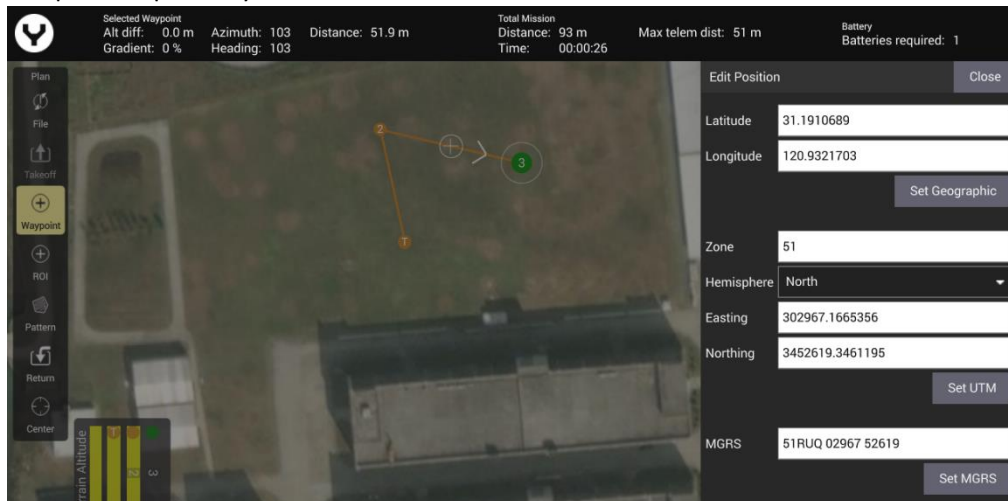

After all the waypoints have been checked, please upload the flight mission to the drone, and then start it.

Pattern

Pattern is designed for mapping and 3D scanning of ground-based objects.

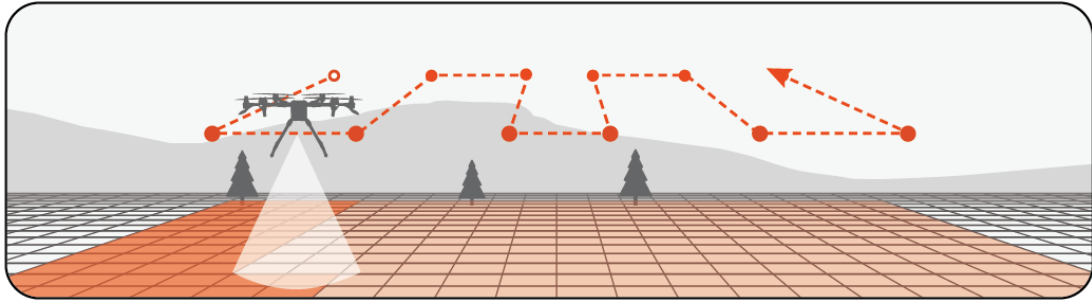

Survey Mode

Survey mode allows the Pilot to quickly place a survey grid over a desired area. To select a survey grid mission, tap the Survey button after tapping the Mission Route Setting icon.

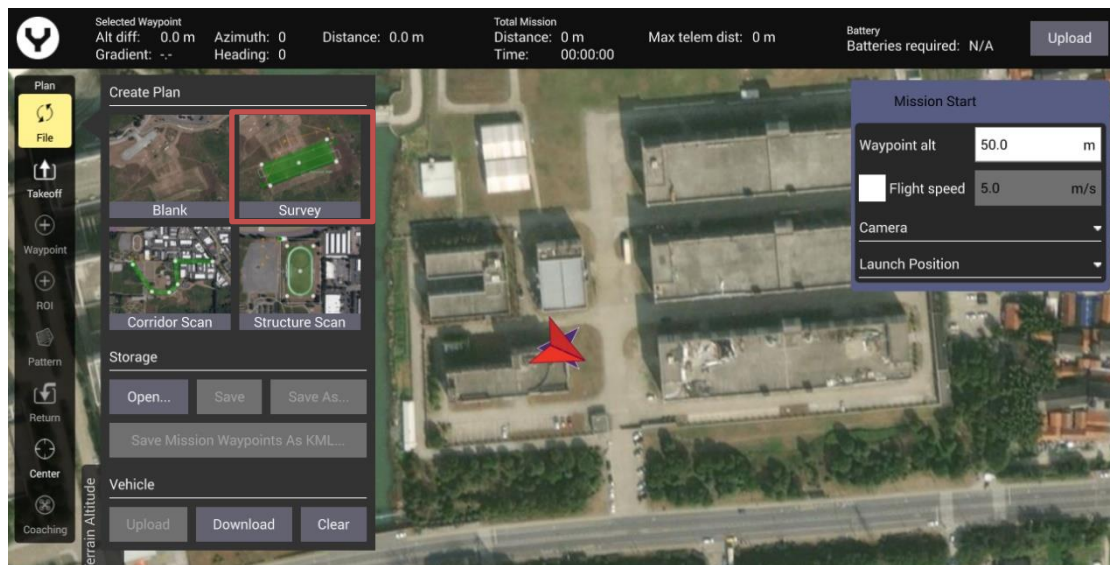

Then tap the Survey button on the right side of the screen to finish the further settings.

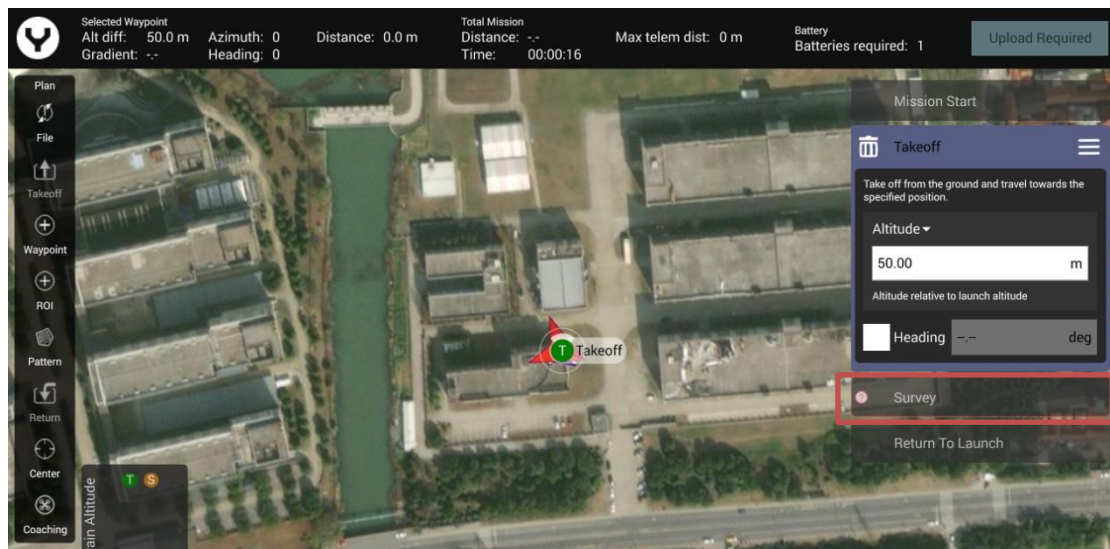

There are 3 preset templates to choose from for editing the survey area.

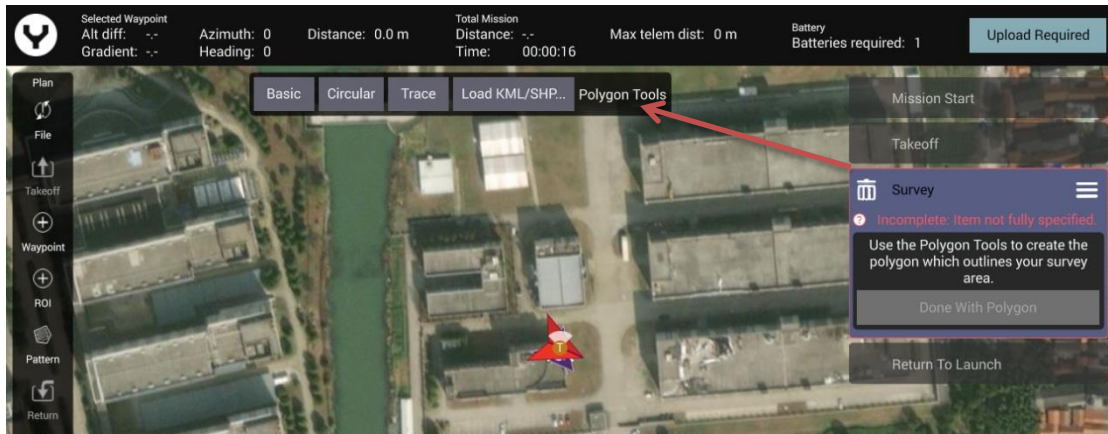

Basic preset template overview



Tap the “Basic” button, the App will generate a rectangle survey area.

Tap and hold the Centre dot to drag the survey area on the map.

Tap and hold the white vertices then drag them to adjust the shape of the survey area.

Tap ‘+’ dot allows the Pilot to add more white vertices to the edge of the survey grid for a better fit.

Circular preset template overview



Tap the “Circular” button, the App will generate a circular survey area.

Tap and hold the Centre dot to drag the survey area on the map.

Tap the white dot on the edge of the Circle to adjust the radius of the survey area.

Trace preset template overview

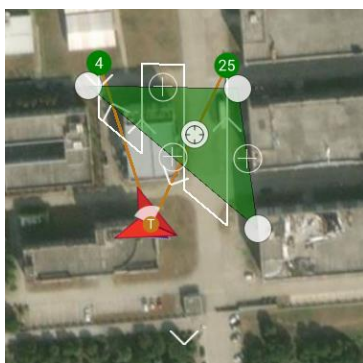

Tap the “Trace” button, then tap on the screen to set the vertex of your survey area. Once you have no less than 3 vertices a triangular survey area will be generated automatically. The operator can add more vertices to get a better fit.

Tap and hold the Centre dot to drag the survey area on the map.

Tap and hold the white vertices then drag them to adjust the shape of the survey area.

Tap ‘+’ dot allows the Pilot to add more white vertices to the edge of the survey grid for a better fit.

The white line in the green survey area means the flight route when surveying.

After the green template covered the survey area you want on the map, please tap the “Done

with Polygon” button and then tap the “Done Adjusting” button for the further settings.

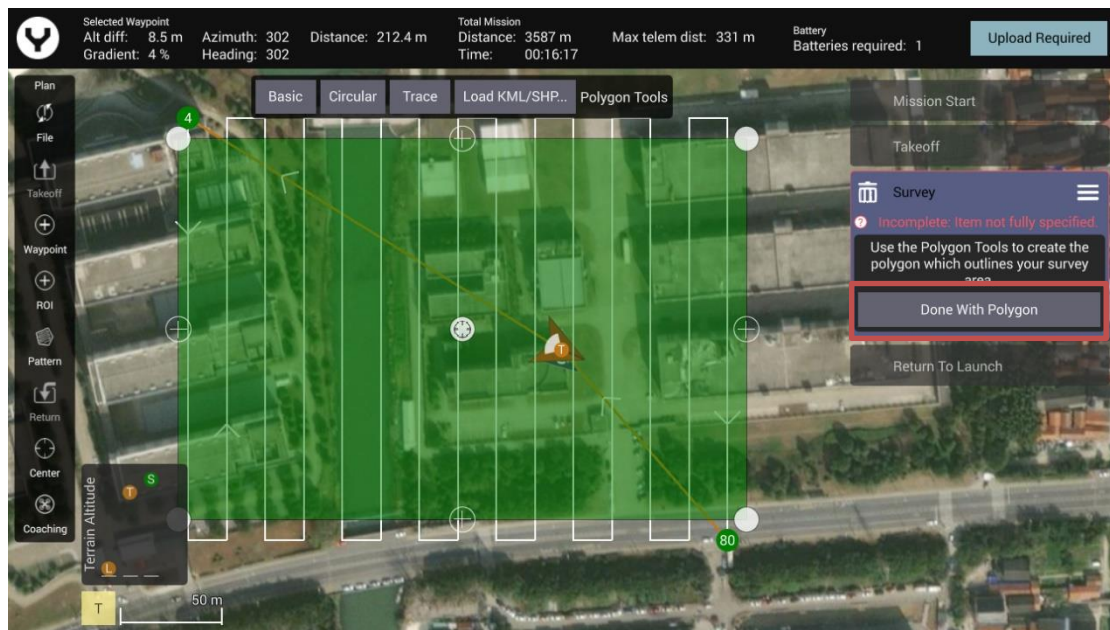

Notice: For the Trace template, please tap the “Done Tracing” First, and then tap the “Done with Polygon” and other buttons.

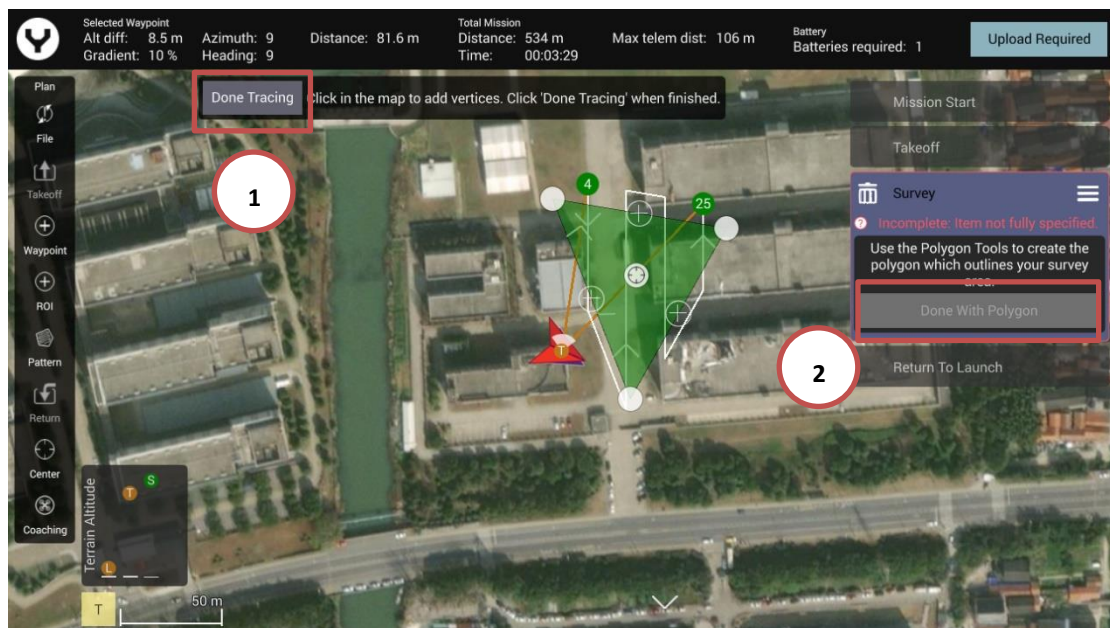

Adjust the Survey parameters

After the Survey area has been confirmed the operator can adjust the survey parameters. Click the “Grid” tab under the selected survey mission to adjust the flight route.

Overlap

Front Overlap – Creates images with a percentage of each image overlapping to the front of the image.

Side Overlap – Creates images with a percentage of each image overlapping to the side of the image.

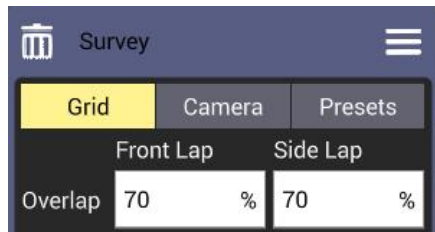

	Front Lap	Side Lap
Overlap	70 %	70 %

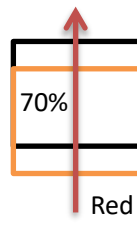

Front Lap for 2 photos

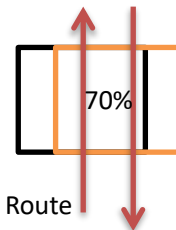

Side Lap for 2 photos

Red Arrow: Flight Route

Altitude or Ground Res

Altitude – Sets the survey grid altitude. This is not changeable mid-flight. Use the Waypoint tool when variable altitudes are required.

Ground Res – Sets the ground resolution in inches/pixel, which will automatically calculate and set the survey altitude.

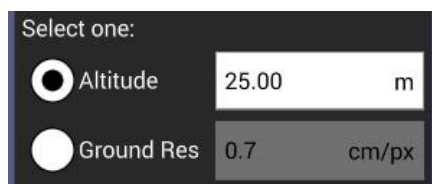

Select one:

Altitude 25.00 m

Ground Res 0.7 cm/px

Select one and type in the parameters directly.

Note: A higher ground resolution requires a lower flight altitude. If unsure about ground resolution altitude, enter desired ground resolution then view the corresponding altitude in the altitude setting (greyed out), and vice versa.

Notice: When the “Manual (no camera specs)” was selected under the camera item, the Overlap will be replaced by the Trigger Dist and Spacing setting form and the Ground Res will be hidden.

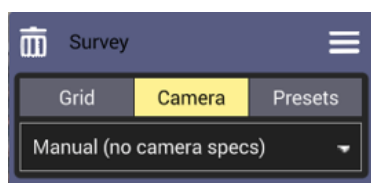

Survey

Grid Camera Presets

Manual (no camera specs)

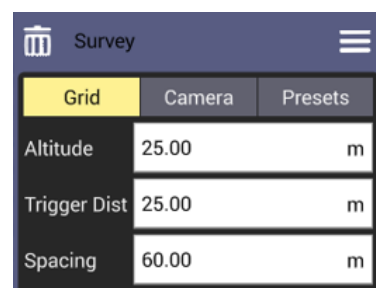

	Altitude	Trigger Dist	Spacing
	25.00 m	25.00 m	60.00 m

Angle

Angle – Drag the slider or type in the parameter **to** adjust the angle of the survey grid lines.

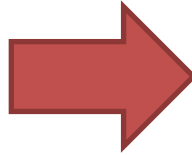
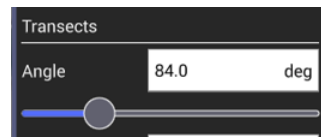
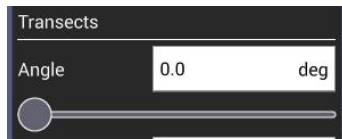

Turnaround dist

– Sets the distance outside the survey for the drone to turnaround.

Type in the parameters directly to adjust the distance



Rotate Entry Point Button

-The DataPilot App will offer more than one solution to lead the drone enter and exit the survey area, the operator can change the enter and exit point by tapping the “Rotate Entry Point” button according to the actual conditions.



For example the enter point was No.4 waypoint and the exit point was No.130 waypoint by default. After tapping the “Rotate Entry Point” button, the entry and exit points are changed.



Enter Point

Exit Point

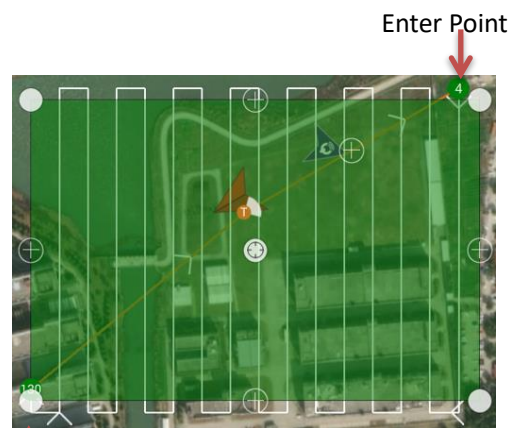

Exit Point

The Operator can also tap the '+' dot on the enter flight route for editing a more complex entering flight route.



Options

Taps the Options to open the Drop-down menu

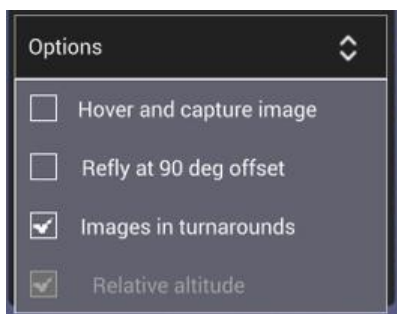

Hover and capture image – After this Item is ticked the drone will stop and hover and then capture the image at each capture point for better image quality.

Refly at 90 Degree Offset – Overlays a secondary survey grid 90 degrees from the first survey (also known as cross-hatch). This feature is useful for extremely high quality maps, and for early morning or late afternoon flights where long shadows may provide deep contrasts.

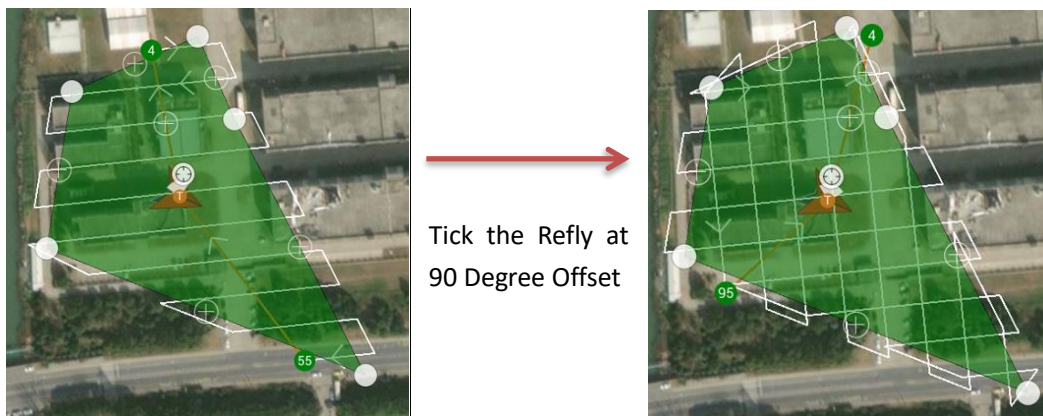

Images in turnarounds – After this Item is ticked the drone will continue capturing images while flying the turnaround route.



Capturing images continuously while flying on the turnaround route.

Terrain

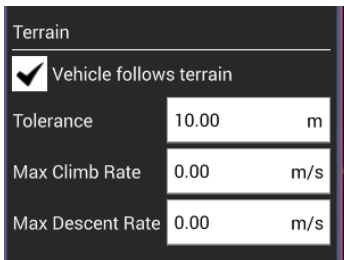

Tap the Terrain button and tick the Vehicle follows terrain to make the drone fly closer to the ground for capturing more pictures or fill the holes in the following inner process work flow.

The operator can type in the parameters directly in the text box for setting.

Statistics



Display the key parameters of this survey mission.

Select the Camera

Different cameras have different sensor size and Lens parameters. Selecting the correct camera type is very important to get a correct flight route and achieve a correct survey result.

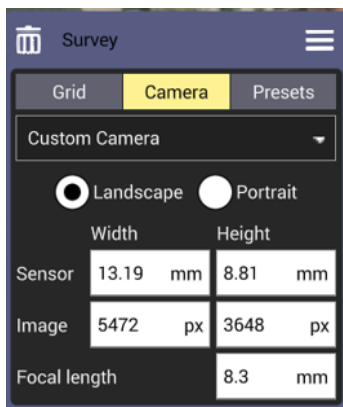

Tap the Camera button beside the Grid button to select the camera type or set the camera parameters.

The operator can set the parameters manually when the Custom Camera was selected.

Type the parameters directly to finish the setting operation.

The DataPilot App also has preset camera select list. The operators can easily select the gimbal cameras purchased

After the camera type was selected the operator does not need to individually set the camera parameters. The app will calculate the flight route and photo taking interval automatically.

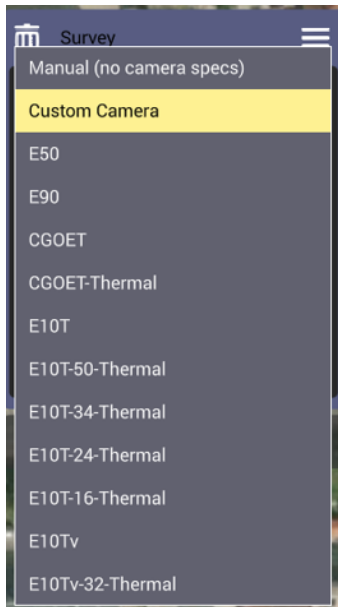

Save reload and delete the survey data

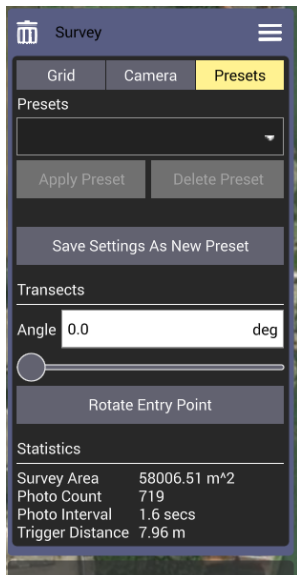

Tap the Presets button to save the setting parameters under the Grid and Camera Items.

Tap the “Save Settings As New Preset” button to create a new save.

Type the name and tap the “Save” button to finish.



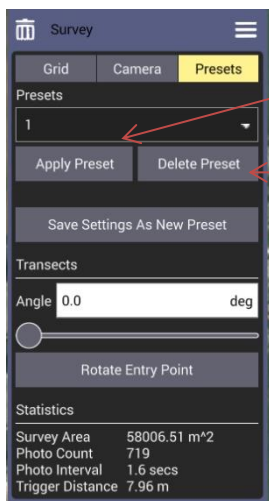
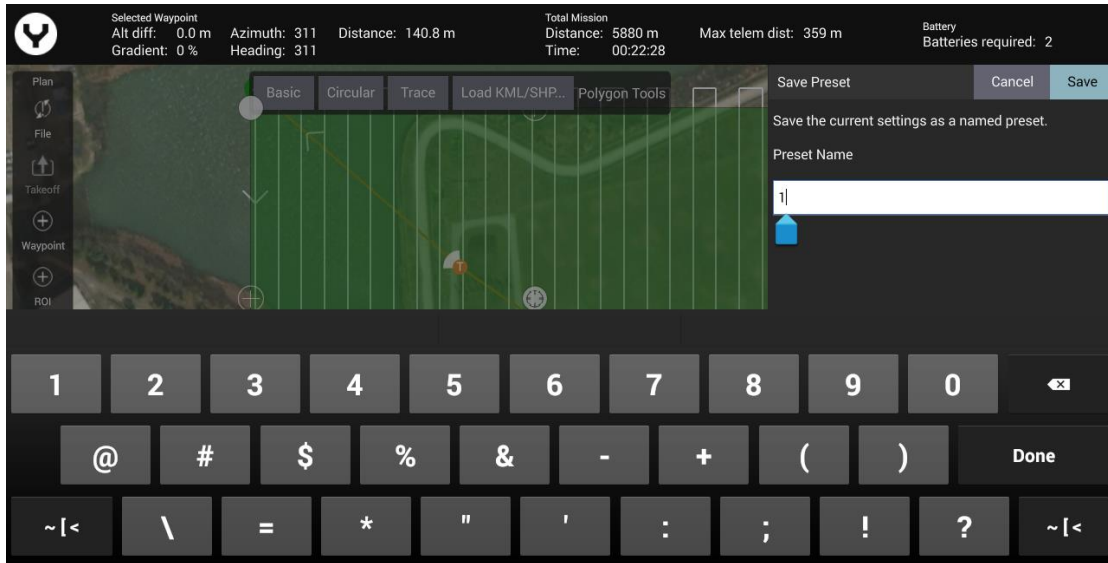

After the file name was selected tap the “Apply Preset” button to load the parameters.

Tap the “Delete Preset” button to delete the useless preset files.

Tap the trash can icon  beside the Survey to delete the whole survey mission.

CORRIDOR SCANS

Roadways, power lines, train tracks, footpaths, and other narrow winding areas may be set up as “corridor scans.” Corridor scans enable the drone to fly long pathways with overlap for these sorts of missions.



This is an example of a corridor scan

To create the CORRIDOR SCAN, tap the Corridor Scan button after tapping the Mission Route Setting icon.

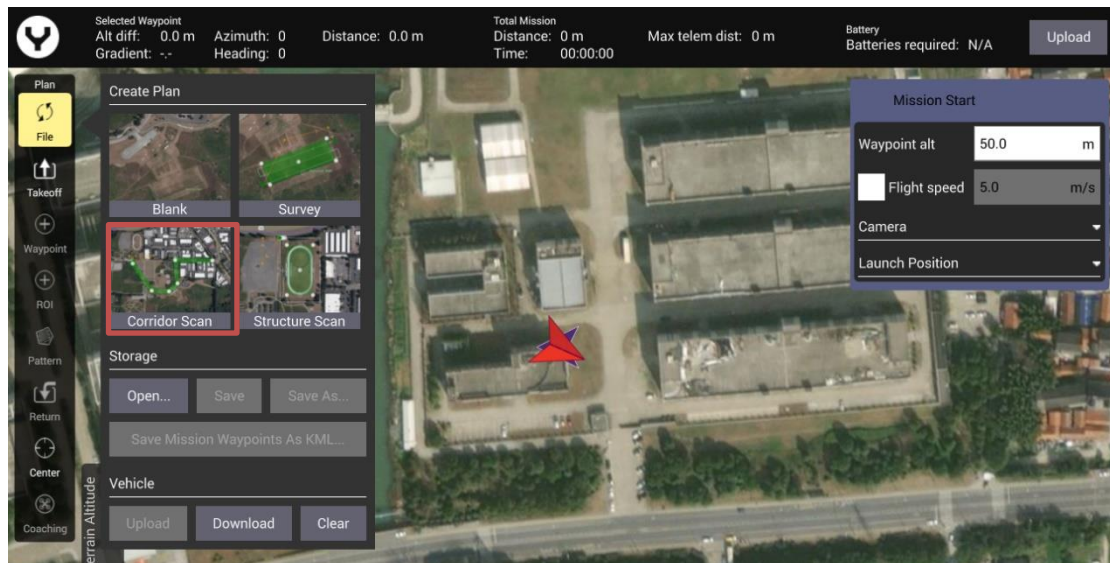

If the transmitter is already connected to the drone and the drone GPS position was established, the takeoff point will be set above the drone location, otherwise place the takeoff point at the position you need then tap the “Done Adjusting” button to finish setting. Then the app will switch to Corridor scan setting panel automatically.

There are 2 preset templates to choose for editing the Corridor Scan area.

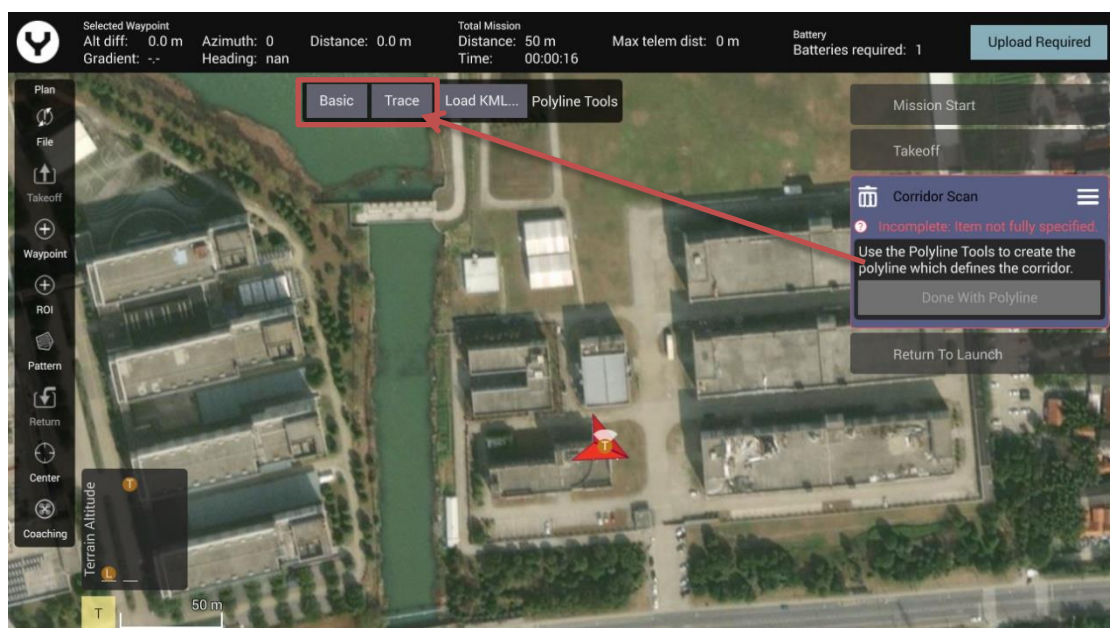

Basic preset template overview



Next tap the “Basic” button, the App will generate a corridor scan area with 2 vertices.

Tap and hold the vertices dot to drag the corridor scan area on the map.

Tap ‘+’ dot allows additional vertices to be created/inserted in the pathway, allowing for numerous angles to follow the road.

Trace preset template overview



Next tap the “Trace” button, then tap on the screen to set the vertex of your corridor scan area. Once you have no less than 2 vertices. A corridor scan area will be generated automatically. The operator can add more vertices by tapping on the screen directly to allowing for numerous angles to follow the road.

Tap and hold the vertices dot to drag the corridor scan area on the map.

Tap ‘+’ dot allows additional vertices to be created/inserted in the pathway, allowing for numerous angles to follow the road.

Click the “Done Tracing” button to finish the shape settings of the Trace template.

After the green template covered the corridor scan area you want on the map, please tap the “Done with Polygon” button the further settings.

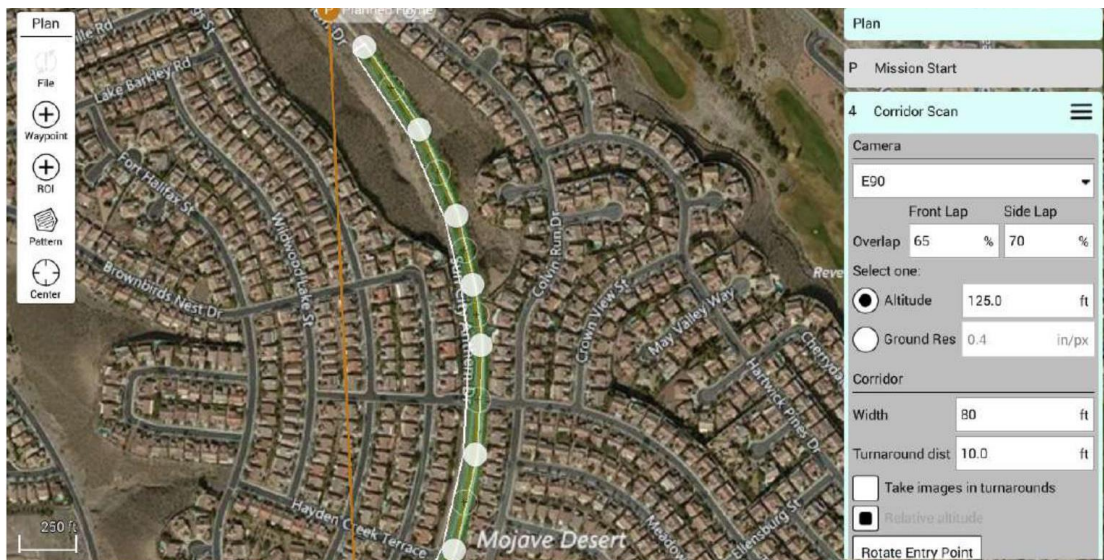

In this image, seven vertices have been inserted, allowing the Drone to follow the curvature of the roadway

Notice: Be similar with the Survey mode the CORRIDOR SCAN Setting Panel shown on the right

side. Through this panel the operator can set all the CORRIDOR SCAN parameters. Drag the panel up and down to view more items.

Adjust the Corridor Scan parameters

After the Corridor Scan area has been confirmed the operator can adjust the scan parameters. Click the “Grid” tap under the selected Corridor Scan mission to adjust the flight route.

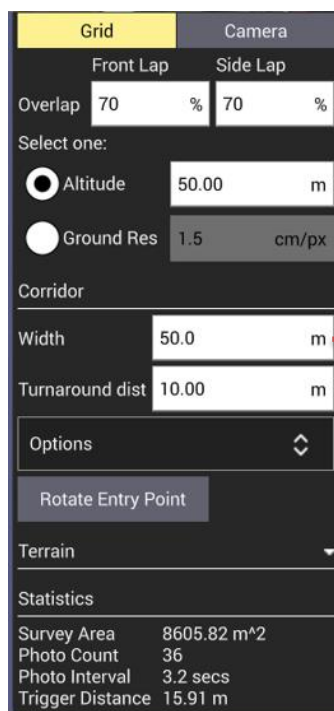

The most functions in the Corridor Scan Setting Panel are the same as what in the Survey function.

But the Corridor Scan Setting Panel still has a function that the Survey doesn't. That is Width Setting.

Type the width parameter directly in the text box to adjust the width of the corridor.

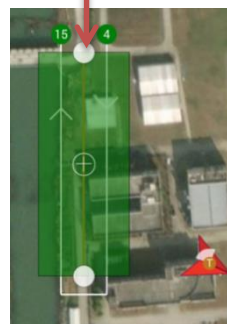

Select the Camera

As the same as the Survey mode, selecting a correct camera is especially important to achieve a correct result.

STRUCTURE SCANS

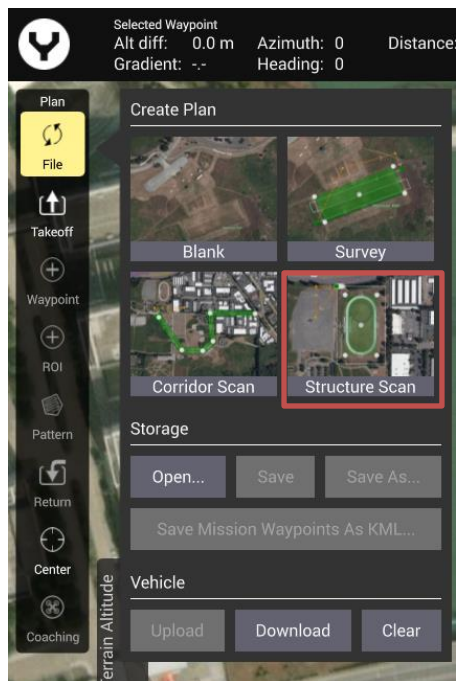

A Structure Scan allows the operator to create a grid

Flight pattern that captures images over *vertical surfaces* (e.g. walls) around a structure with an arbitrary polygonal (or circular) ground footprint. Structure Scans may be combined with nadir/survey flights to better serve architects, engineers, and construction companies looking to create accurate 3D models, or output .las files to products such as Revit or Autodesk workflows.

Structure scans may also be used for virtually any vertical scan element, and may be combined with other automated flight profiles.

The concepts of the STRUCTURE SCANS Function ->

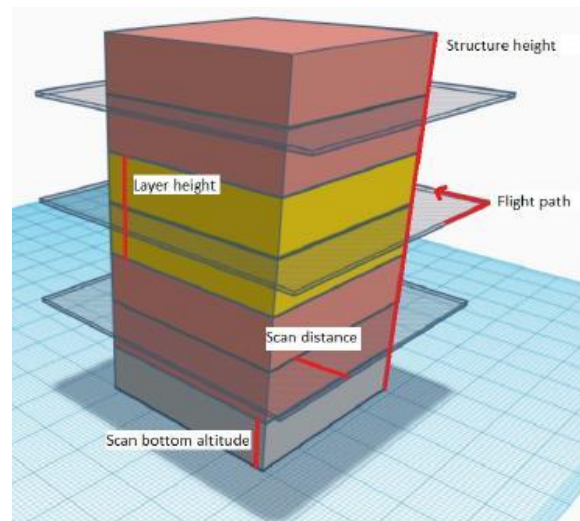

Structure Scans may be inserted into a mission using the Structure scan button after tapping the Mission Route Setting icon.

Using the map function, zoom to the geographic area to be scanned, and centre it on the screen for best access.

Being similar to the Survey mode, there are 3 preset templates to choose from for editing the Structure Scan area after tapping the Structure Scan button and the takeoff point was set.



Basic preset template overview

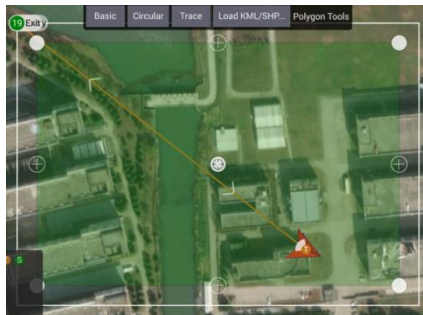

A green overlay will appear with four corners.

Tap and hold the Centre dot to drag the survey area on the map.

Tap and hold the white vertices then drag them to adjust the shape of the structure scan area.

Tap '+' dot allows the Pilot to add more white vertices to the edge of the structure scan area for a better fit.

Circular preset template overview



Next Tap the "Circular" button, the App will generate a circular structure scan area.

Tap and hold the Centre dot to drag the structure scan area on the map.

Tap the white dot on the edge of the Circle to adjust the radius of the structure scan.

Trace preset template overview



Next Tap the "Trace" button, then tap on the screen to set the vertex of your structure scan area. Once you have no less than 3 vertices. A triangular structure scan area will be generated automatically. The operator can add more vertices to get a better fit.

Tap and hold the Centre dot to drag the structure scan area on the map.

Tap and hold the white vertices then drag them to adjust the shape of the structure scan area.

Tap '+' dot allows the Pilot to add more white vertices to the edge of the survey grid for a better fit.

For the Trace template tap the "Done Tracing" button first, for others please tap the "Done With Polygon" button directly to start the further settings.

A green overlay will appear with four corners. The region shown in green must be modified so that it surrounds the structure.

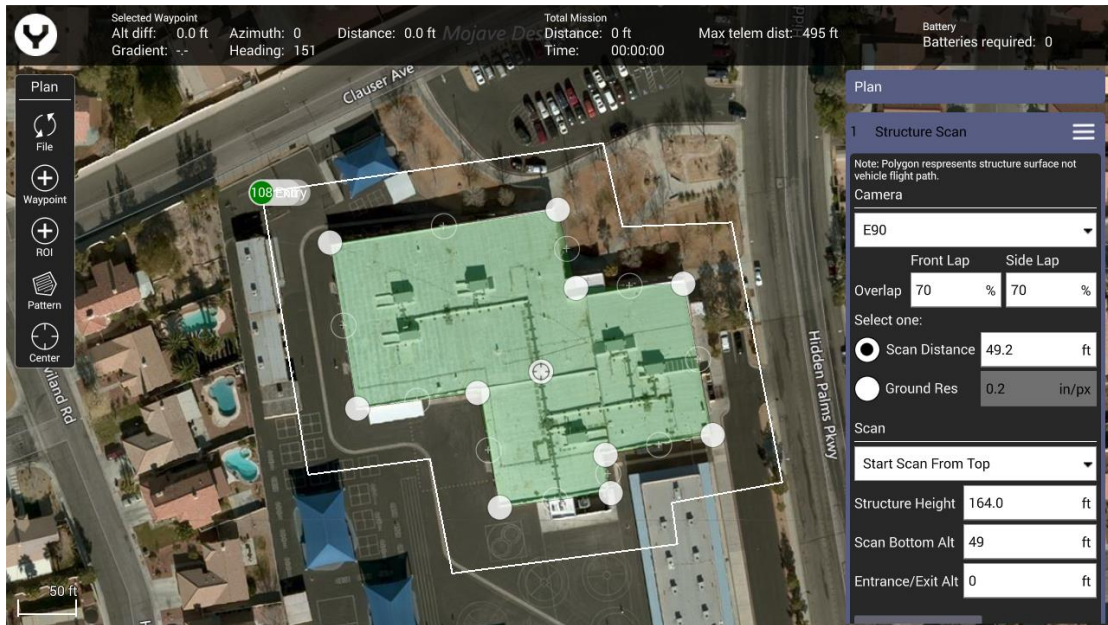

- Drag the opaque vertices on the map to the edge of the structure.
- If the structure footprint is more than a simple square, click the semi-transparent circles between the vertices to create a new vertex. This allows for complex shapes such as the one seen above.

Adjust the Structure Scan parameters

After the Structure Scan area has been confirmed the operator can adjust the scan parameters. Click the “Grid” tap under the selected Structure Scan mission to adjust the flight route.



The operator can adjust the Structure Scan parameters according to actual needs and the concepts of the STRUCTURE SCANS Function introduced above in the Structure Scan setting panel.

Select the Camera

Click the “Camera” tap under the selected Structure Scan mission to enter the camera settings.

Same as the Survey mode, selecting a correct camera is extremely important to achieve a correct result.

Other functions of the Plan Panel

After entering into the Mission planning mode by tapping the Mission Route Setting icon, the File button will be activated automatically. Beside the Waypoint other Pattern missions can be created by tapping directly on the pop up create plan window, the operator can also save the created flight plan or open an existing plan

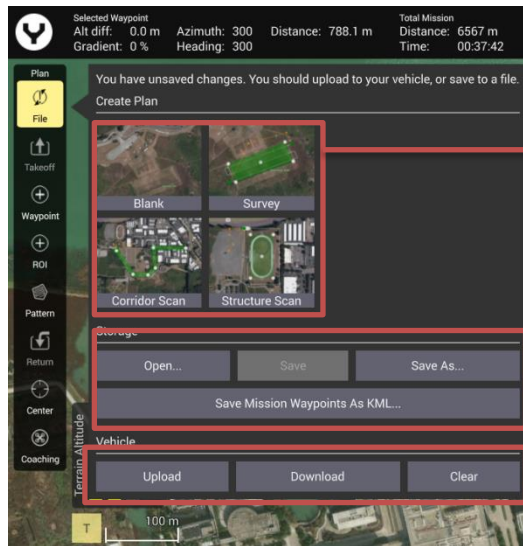

Select a flight plan type to create.

Open or save the created flight plan as .plan or .KML file.

Upload the flight plan to the drone.
And Download or Clear the flight plan stored in the drone.

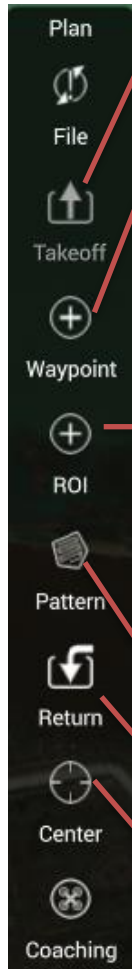

Tap to add a Takeoff point on the map. Normally when the drone GPS position is established, the takeoff point will coincide with the drone. Otherwise the operator needs to add the takeoff point manually. This function is mostly used in planning a waypoint flight plan. The Pattern flight plan, such as survey etc. will create a takeoff point automatically.

Add the waypoint on the map.

Add the region of interest point on the map. Tap the ROI button then tap on the map directly to add the ROI point and set the altitude. Then the waypoints which are added after the ROI point will point their gimbal camera towards the ROI point.



The same as with the waypoint function the operator can set the altitude, delete or edit the position by going through the menu of sub menus of the ROI Setting panel. The flight routes marked with green colour indicate which the ROI function is active.

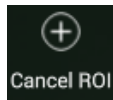

Once a ROI point was set the Cancel ROI button will instead the ROI button, click to deactivate the ROI function on the flight route, but not delete directly.

Insert new Pattern flight plan on the map.

Tap to add a Return to launch command after all the flight mission was finished.

Tap the Centre button to open the sub menu to select the centre point located on the screen.

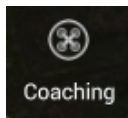

After the drone and transmitter are connected the Coaching button will be displayed on the plan setting panel.

The coaching function will allow the Datapilot 2.0 App to capture the drone current GPS position as a new waypoint.

Tap the takeoff button to add a takeoff point for the Blank flight plan, and then tap the Coaching button, the operator can add a waypoint by a long press on the waypoint button.



After all the waypoints have been captured tap the Mission Route Setting Button to upload the waypoint data to the drone.

Execute the flight mission

No matter what kind of the flight plan was created, to execute the operator needs to upload the plan to the drone first.

After the flight plan was confirmed and the drone is connected, tap the “Upload Required” or “Upload” to upload the mission to the drone.

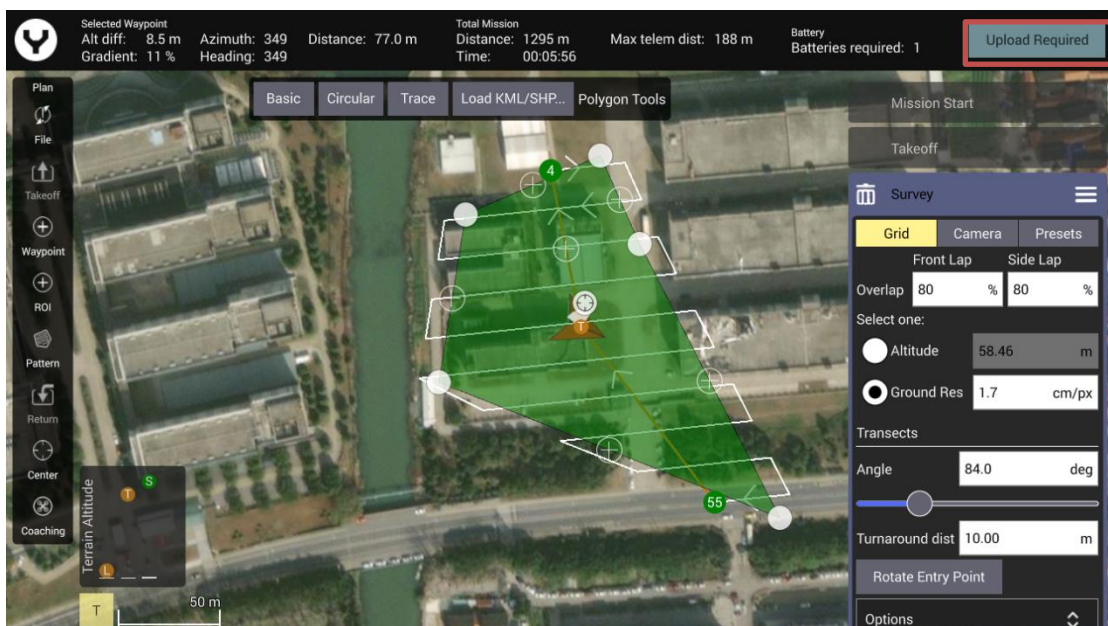

Tap the Main Interface Button to switch back from the Mission planning interface.

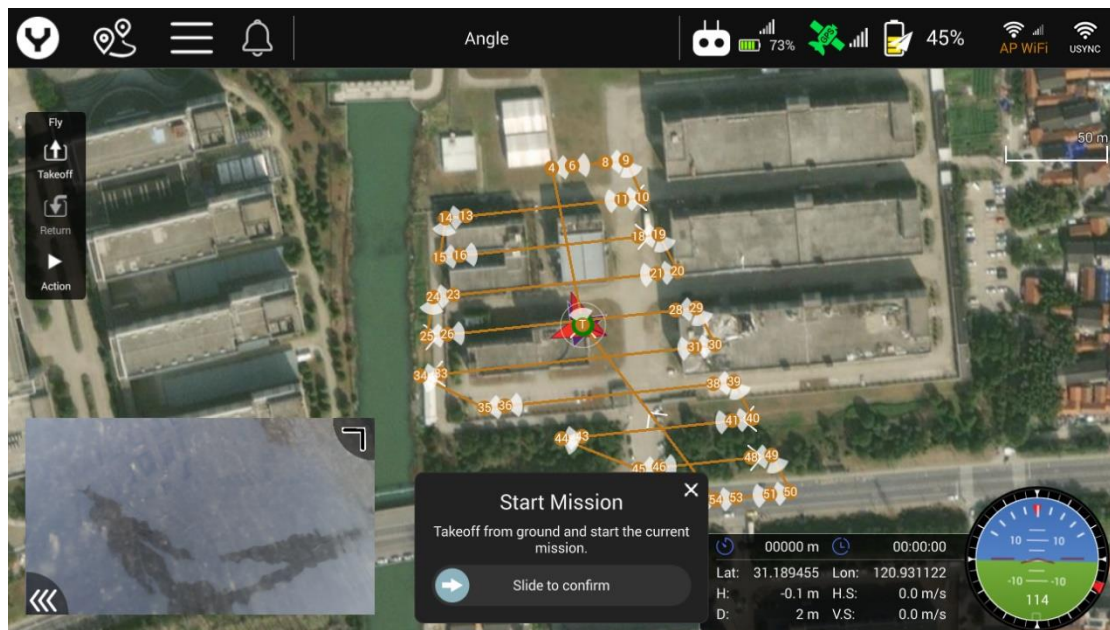

Slide the slider to confirm and the drone will execute the flight mission automatically.

Operations in mission flight mode

Pause the flight mission

The operator can pause the flight mission by the following 3 method:

1. Switch the flight mode by using the flight mode switch.
2. Tap the Pause button then slide to confirm.



3. The operator can move the joysticks to any direction to pause the flight mission immediately especially in emergency cases, such as the drone could hit an obstacle.

Continue the flight mission

1. Slide the slider to continue the mission.



2. Tap the Action button then select continue or set the new altitude.

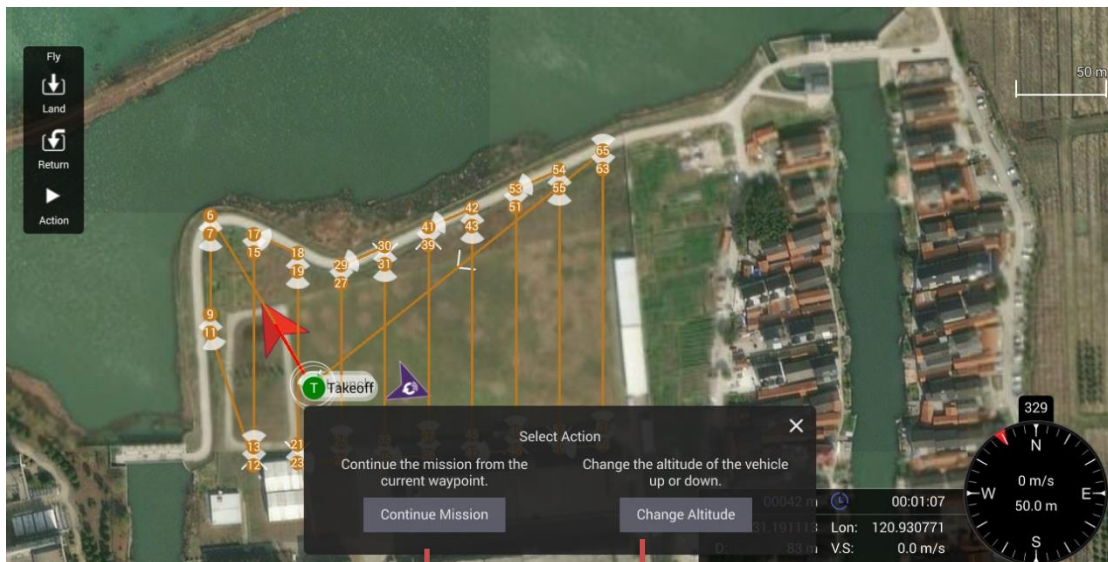

Tap the "Continue Mission" button then slide to confirm to continue the mission.

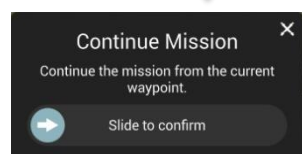

Set the new altitude then slide to confirm.

Then Tap the "Continue Mission" button under the Select Action sub menu to continue.



Land or Return in mission flight

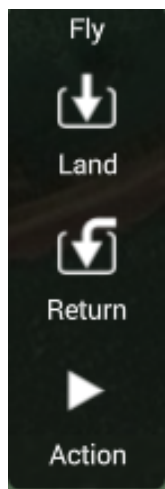

Tap the Land button and slide to confirm then the drone lands at the current position.

Tap the Return button and slide to confirm then the drone returns to the launch point.

Breakpoint continuation

Sometimes surveying a huge area, the drone can't finish the job in 1 flight. The breakpoint continuation function allows the operator to change the drone battery and continue the unfinished mission.

When the drone has landed with the mission unfinished, the dialog box will pop up as in the picture below

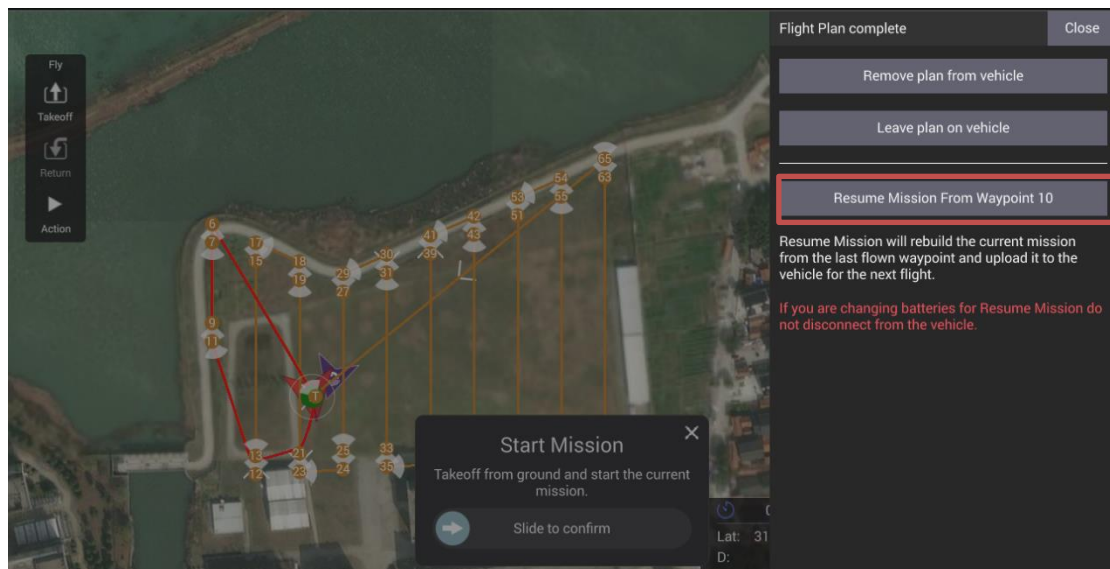

Tap the "Resume Mission From Waypoint XX" button and the mission will be updated. It will delete the flight route already finished.

Notice: It will take a few minutes to update if there are a large number of waypoints in the mission, please be patient, do not power off the drone and transmitter before the mission has been refreshed.

Then the operator can power the drone off and change the battery.

After the drone and the transmitter are connected again, the unfinished flight mission will be loaded automatically, and the operator only needs to slide to confirm to continue.

After the drone and the transmitter are connected again:

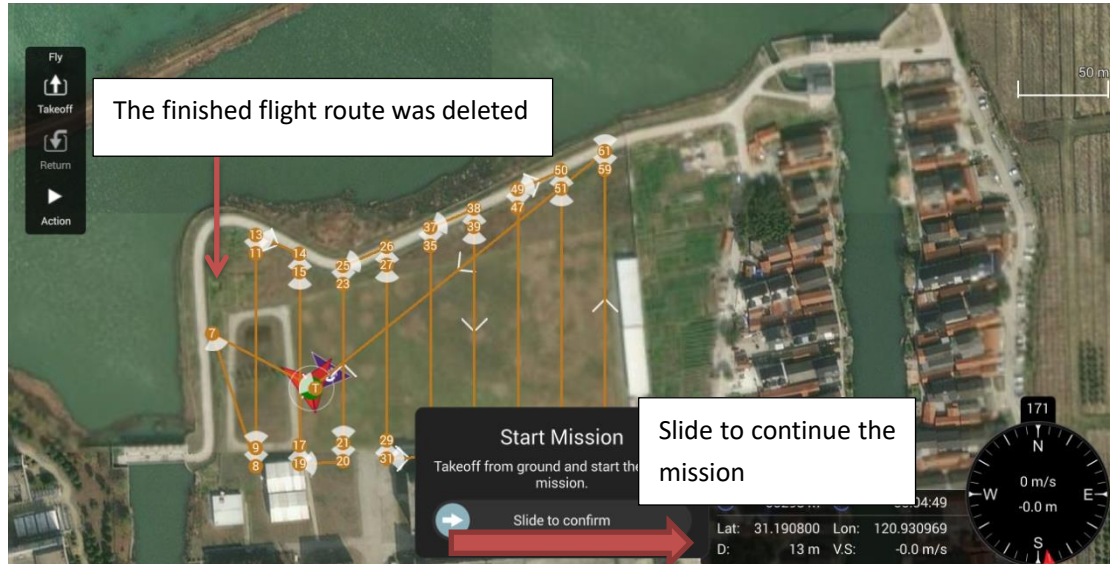

Setting Interface

Tap the settings button to open the extended menu to view and adjust the parameters of other settings. We suggest entering this interface after the drone and transmitter are connected to view all the items in this interface.

Notice: Due to the DataPilot 2.0 App is a cross platform flight control application, beside the H850, there are many items in the setting interface that are designed for other types of drone such as H520E and Q820, please ignore the items which are not featured in this manual. They may be not compatible or the H850 drone doesn't have this function.

Introduction of common functions in setting interface

1. General

Units: s Operator can make selections according to their own requirements in the drop-down menu.

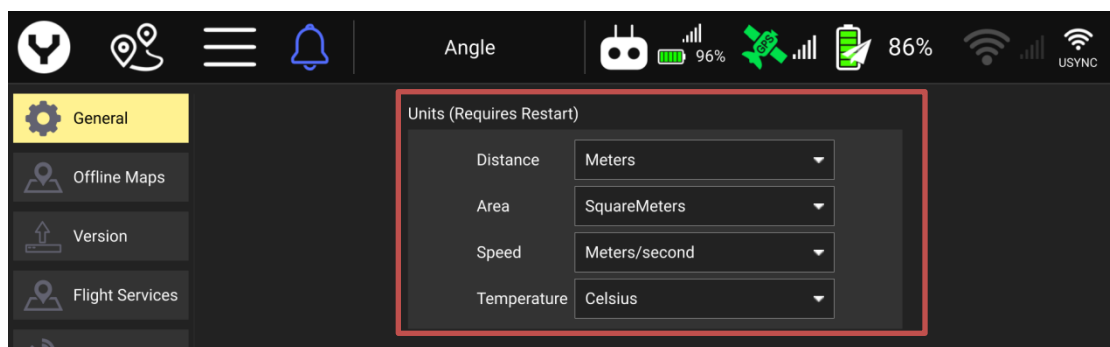

Miscellaneous

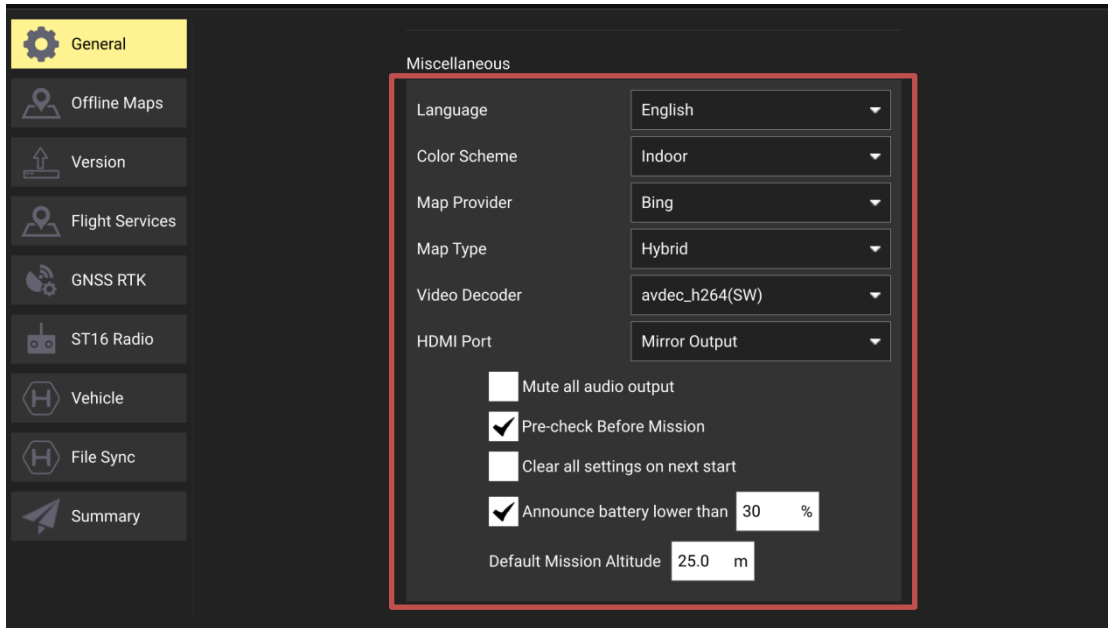

Language- Operator can make selections according to their own requirements in the drop-down menu.

Colour Scheme-The DataPilot 2.0 supports 2 different colour schemes. Indoor scheme will provide a dark interface meanwhile the outdoor has a bright interface.

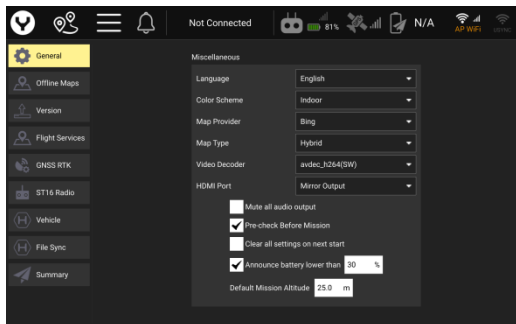

Indoor

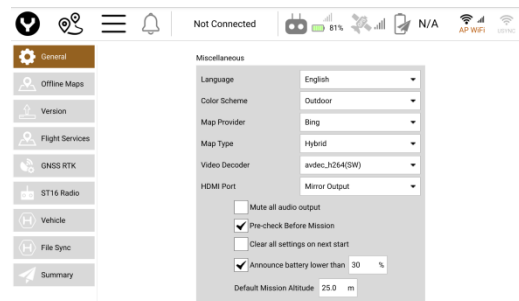

Outdoor

Map Provider and Map Type-The operator can change the map provider and type according to their network speed or requirements.

Default Mission Altitude-Set the default waypoint alt when enter the flight mission plan interface.

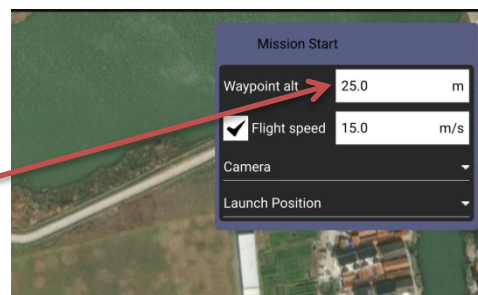
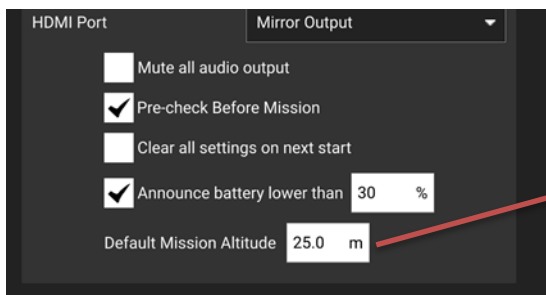

Other settings in General Items-We suggest keeping them as the default setting.

2. Offline Maps

The Offline Maps allows the Datapilot 2.0 App store the map tile in the cache in the transmitter for working in the field without the internet.

After the transmitter is connected with the internet the map will be downloaded automatically according to the drone or the transmitter GPS position. The first downloaded map will be set as the default tile.

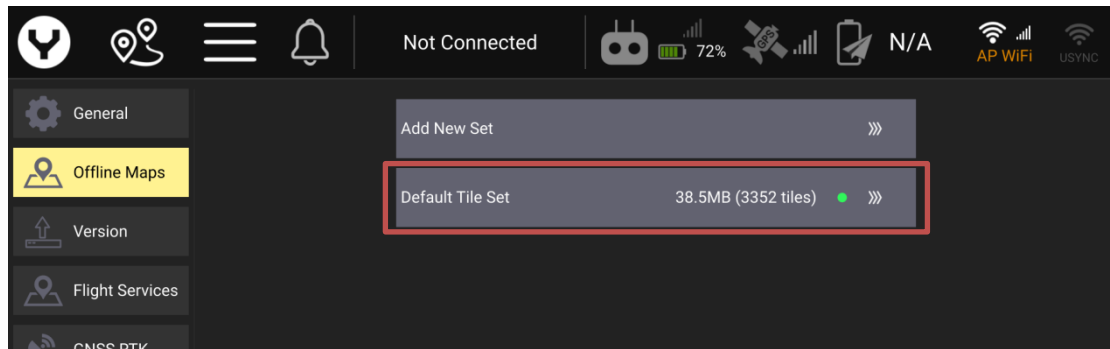

The operator can delete the default tile by tap the “Default Tile Set” button and then tap the “Delete “button.

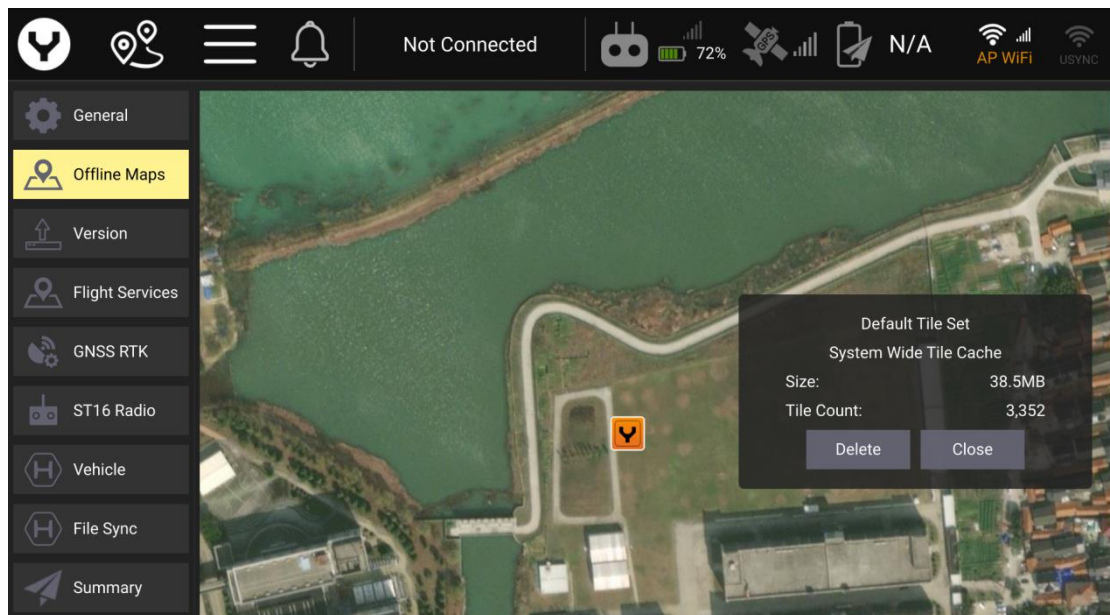

Tap the “Close” button to return.

The operator can also add a new tile set manually beside the default tile set, tap “Add New Set” button to edit.

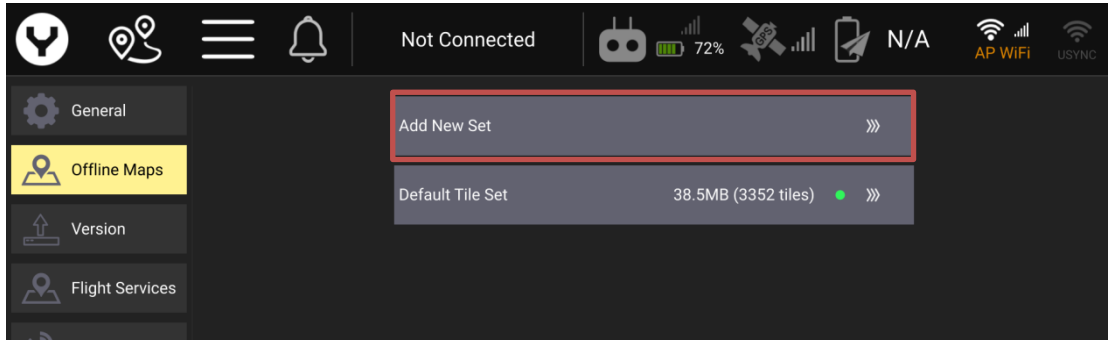

New set edit interface Introduction

Map centre setting button

The operator can tap this button and select the centre position on the sub menu.

New Tile Set Name Edit Box

The operator can edit the name of the new tile set in this box.

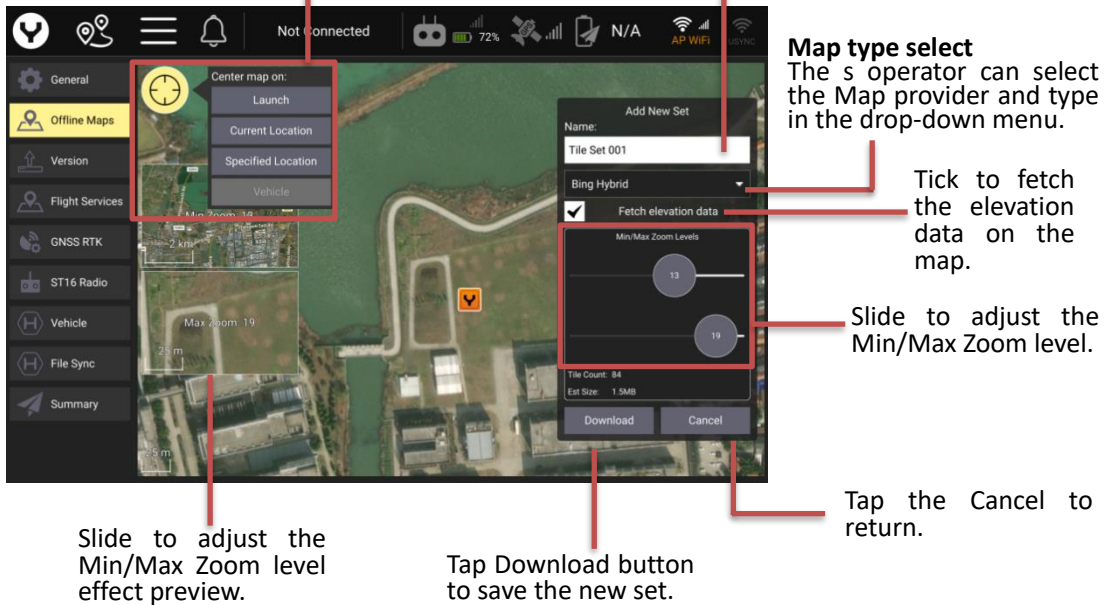

Map type select

The operator can select the Map provider and type in the drop-down menu.

Tick to fetch the elevation data on the map.

Slide to adjust the Min/Max Zoom level.

Tap the Cancel to return.

Slide to adjust the Min/Max Zoom level effect preview.

Tap Download button to save the new set.

After clicking the Download button the new tile set will be downloaded and saved in the Offline Maps menu.

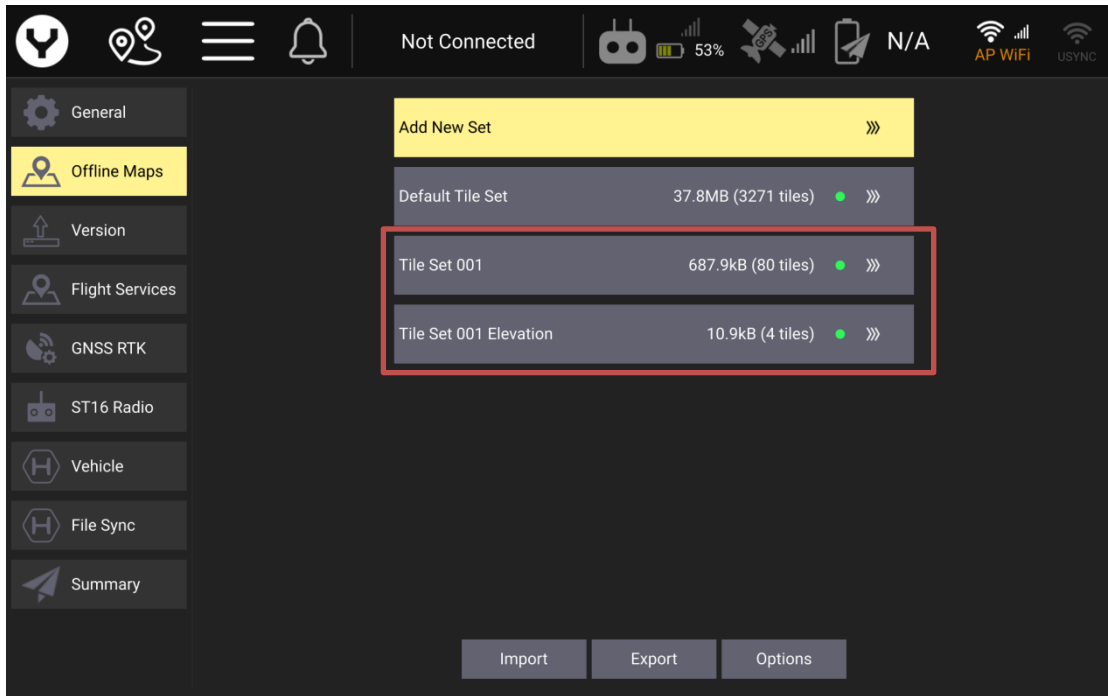

Similar to the Default Tile Set, the new added tile set can be reviewed by tapping the name and can be deleted by tapping the Delete button. The difference is the new added tile set can be renamed and the “OK” button tapped to confirm.



The downloaded map tile set can be imported and exported between devices.

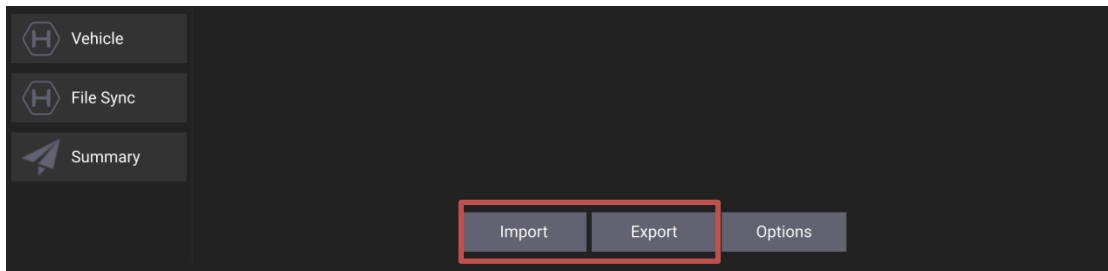

Import

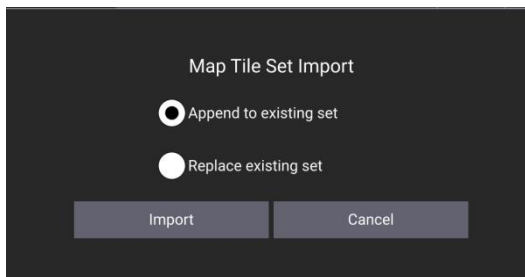

After tapping the Import button, select an import method then tap the Import button on the popped up dialog box and select the file to import.

Export

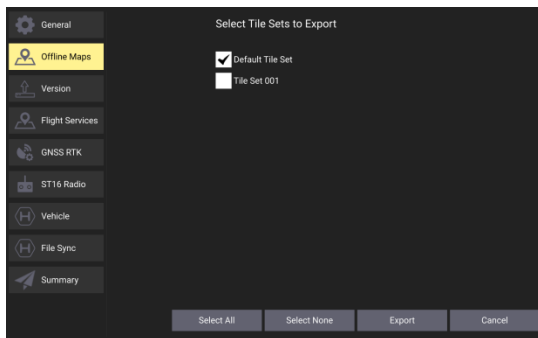

After tapping the Import button on the Offline Maps main interface, tick the tile set wanted and tap the Export button then assign the name and save path on the popped up dialog box, finally tap the Ok button to export.

3. Version

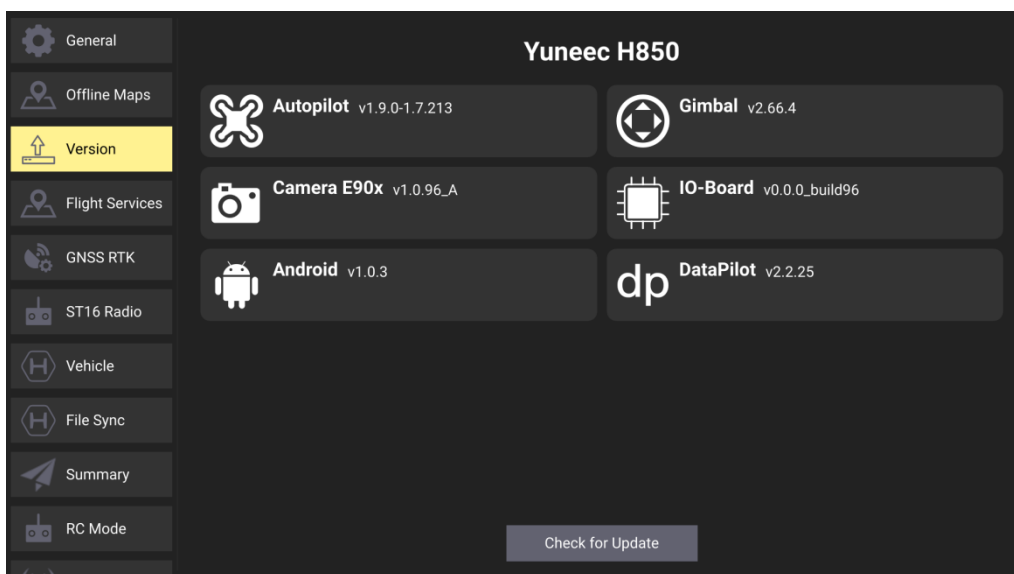

The operator can check the Version of each module or system of the drone. If the transmitter is already connected to the internet the operator can tap the "Check for Update" button to keep the firmware up-to-date.

Once the later version was detected, the update process can be started.

4. GNSS RTK

In the sub menu under the GNSS RTK item the operator can enter to parameters to connect the drone system to the CORS source. Please refer to the corresponding chapter in the quick start Guide and this operator manual mentioned above.

5. T1 ??? Radio

There are 2 functions under this Item the Monitor function was the default interface when tap the T1 ????? Radio button on the screen.

Monitor

Move the Joysticks, Knobs, and Sliders or press the buttons to check the controller hardware input.

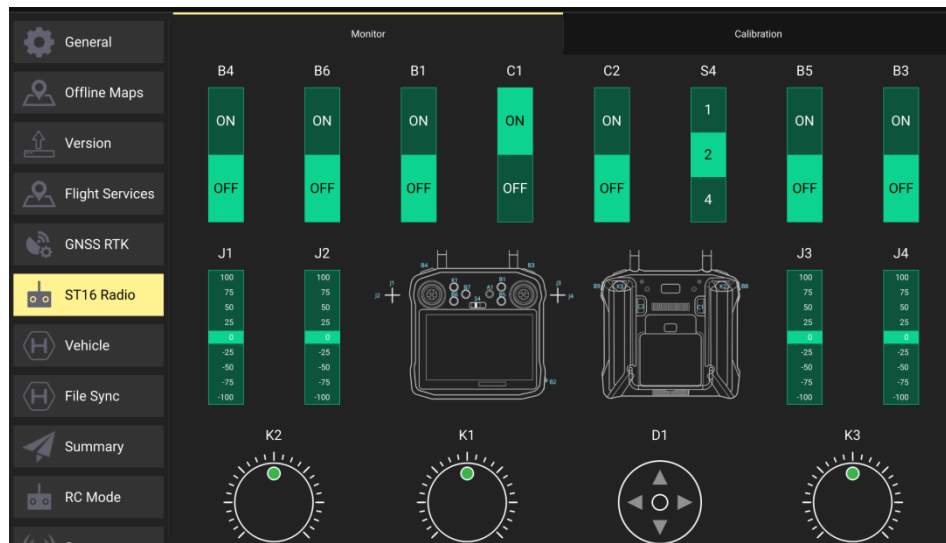

Calibration

Another function in the T1 ????? Radio item is the Calibration.

To calibrate the Joysticks and knobs please power off the drone to disconnect the drone and transmitter.

Then switch to the calibration function by tap the calibration button, and tap the Start Calibration button.

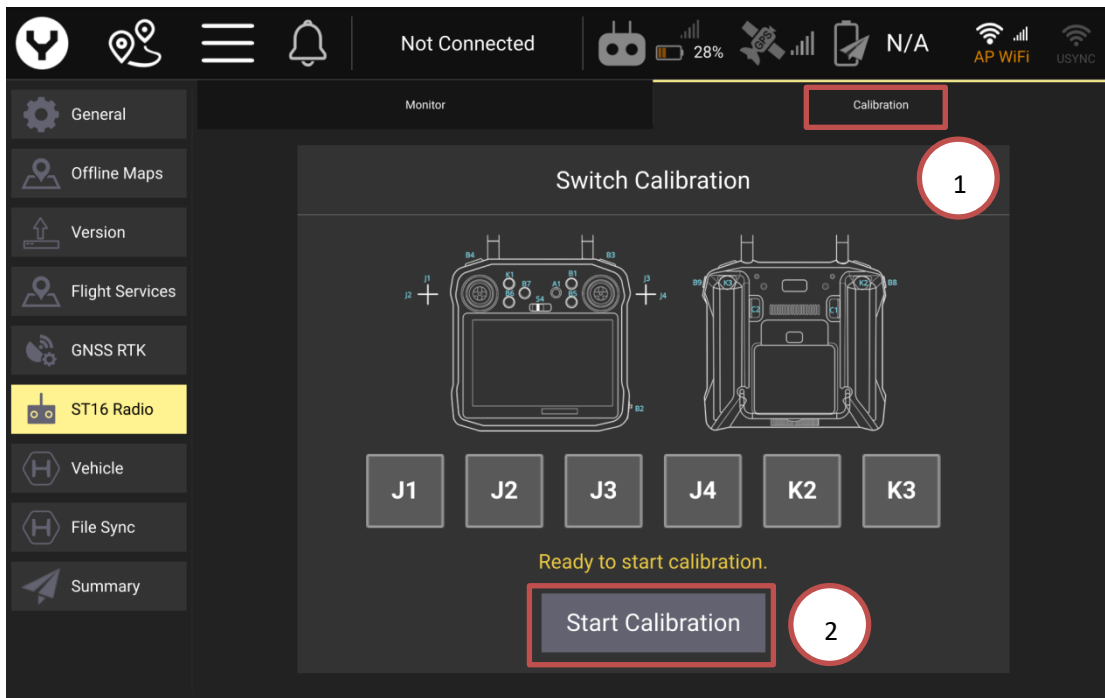

Follow the guidelines of the transmitter to move all the joysticks and knobs to their limits.

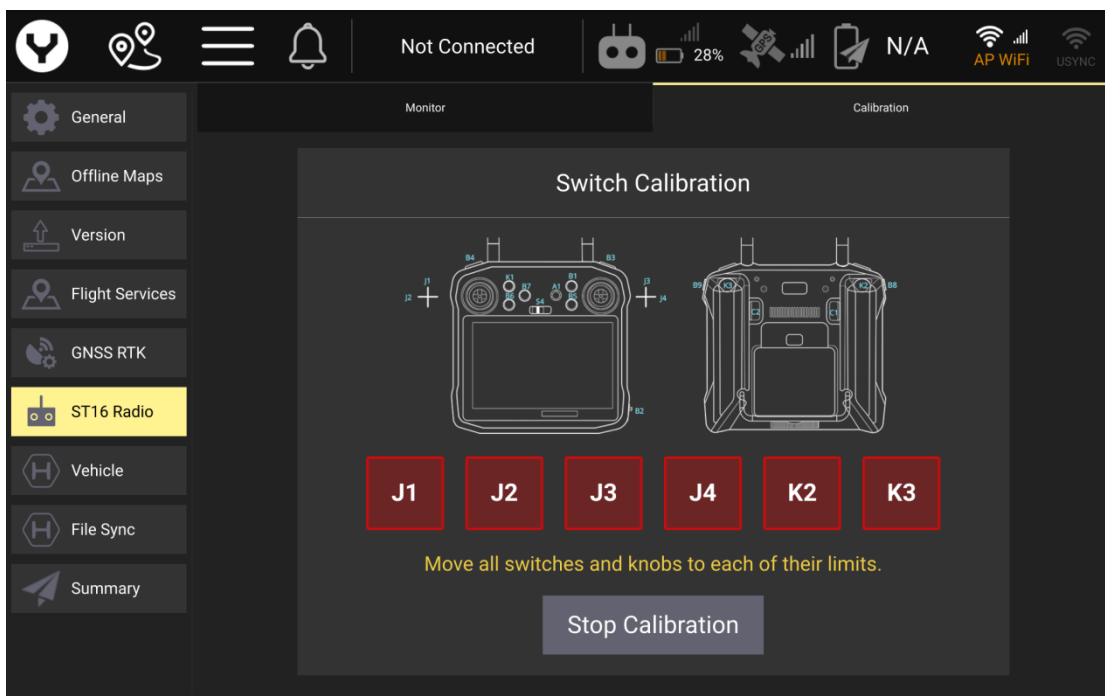

The joysticks and knobs which passed the Calibration will be marked green.

After all of them have passed release your hands from the joysticks and knobs to keep them at the centre position, then tap the Stop Calibration button.

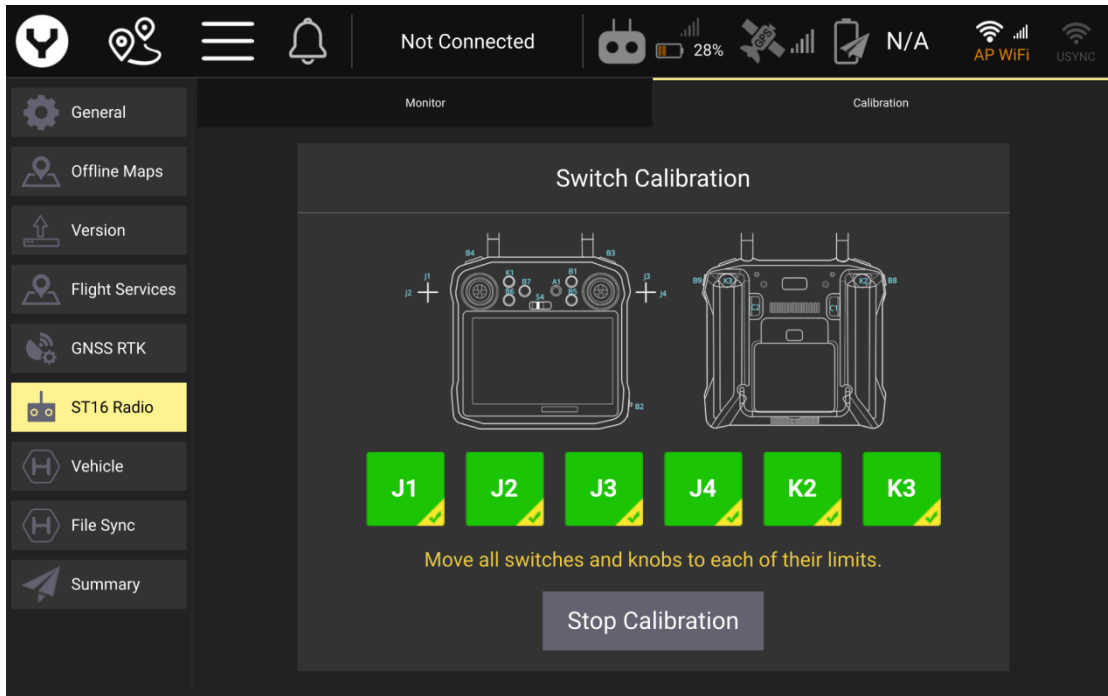

Tap OK button to finish the calibration

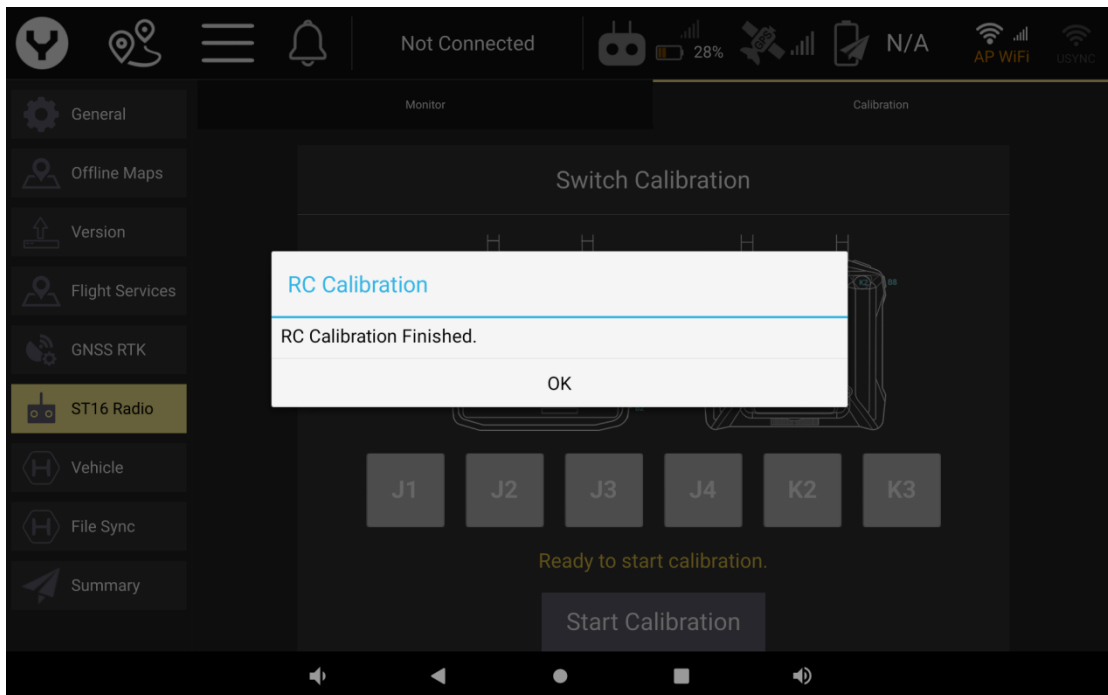

6. Vehicle

The operator can reset parameters, control the motor LEDs, enable the indoor mode, enable the RTK GPS and check the vehicle info under this item.

Reset parameter button

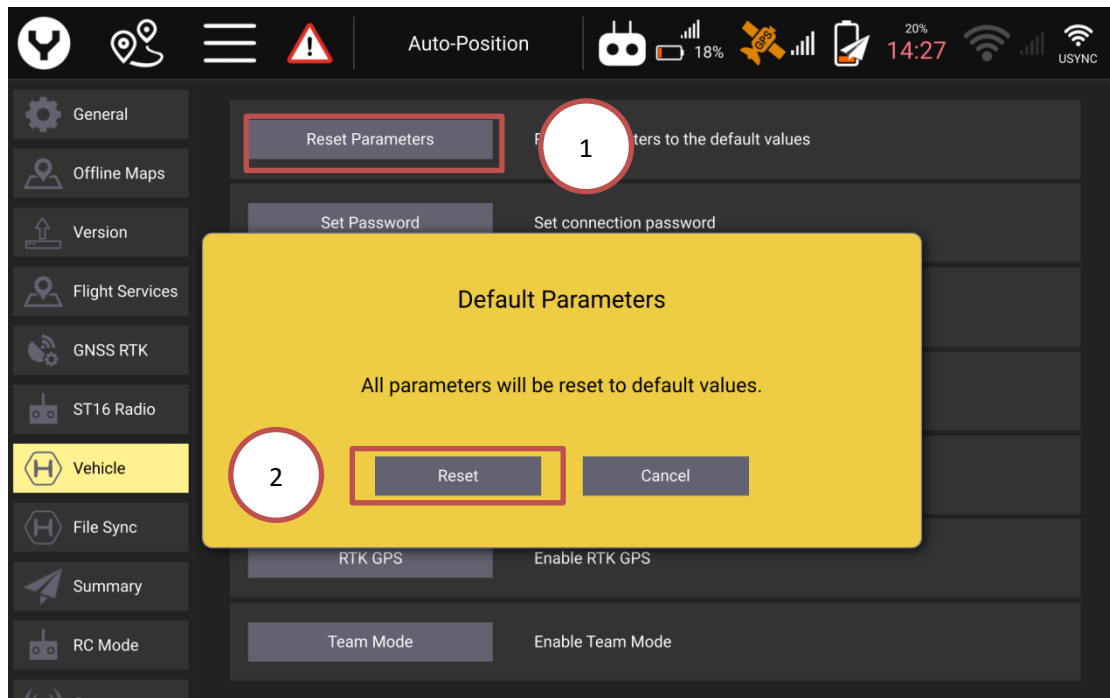

Tap the “Reset Parameters” button first then tap the “Reset” button.

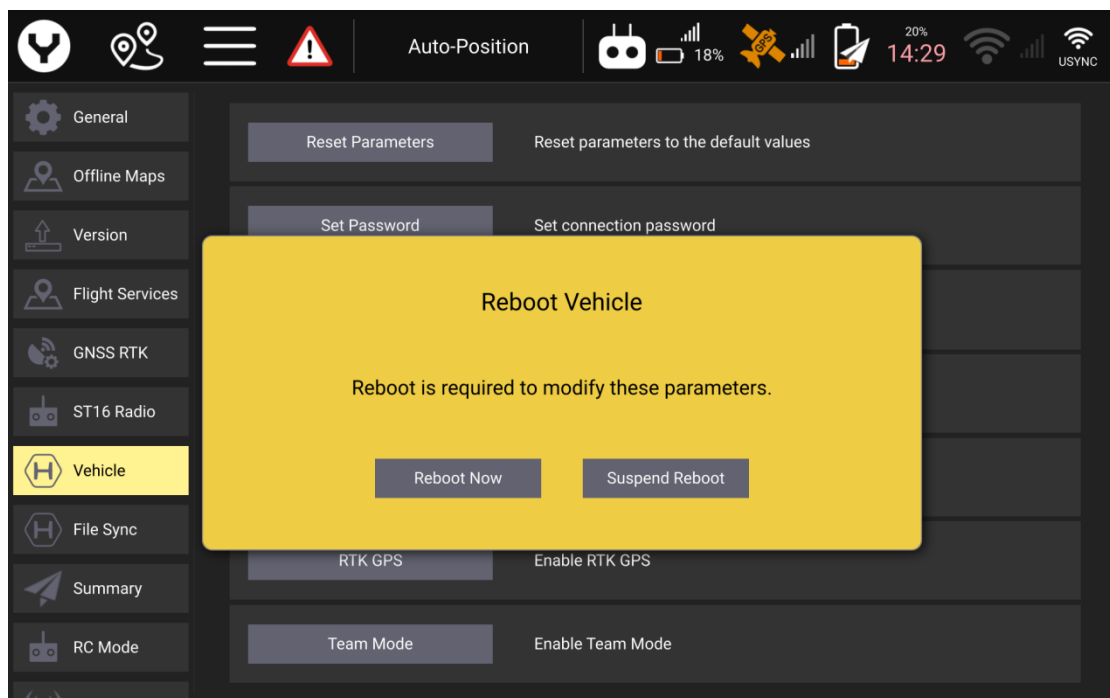

Tap the “Reboot Now” button to reboot drone then the reset will take effect.

LED Control

In the cases of taking the aerial photography at night the motor LEDs can influence the colour effect of the photos. The operator can control the motor LED according to the following introduction.

Tap the white arrow to open the drop-down menu then select the needed LED setting, the LEDs On is the default setting.

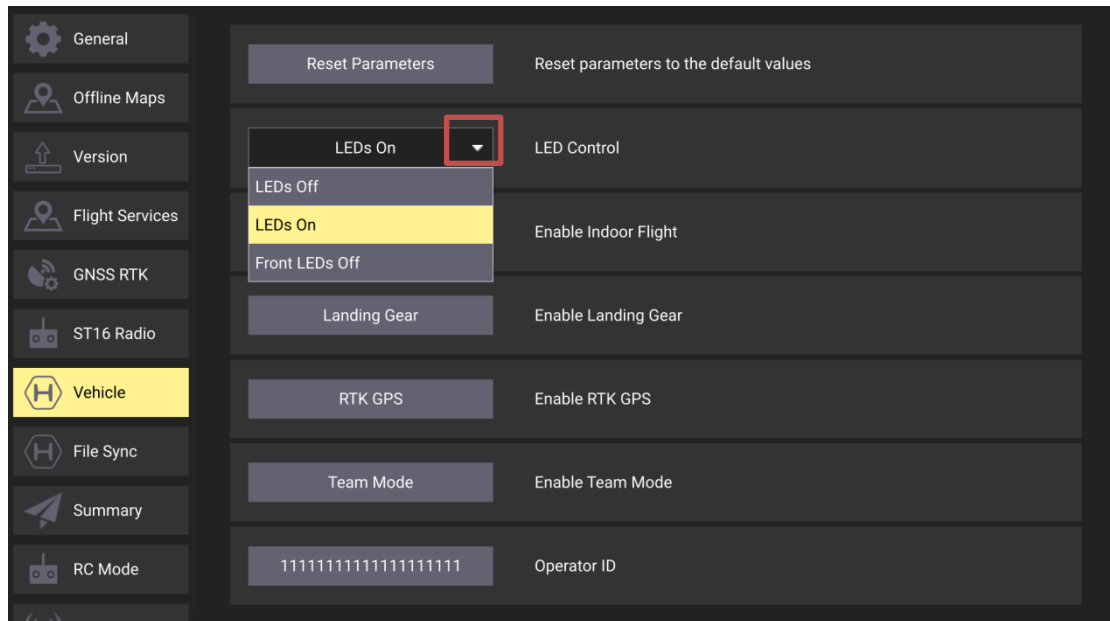

LEDs Off - Switch off all the motor LEDs.

LEDs On - Switch on all the motor LEDs.

Front LEDs Off – Only switch off the LEDs on the front motor arms.

Indoor Mode button

To disable the GPS totally for starting the motors without GPS position, please refer to the corresponding chapter introduced above for more details.

RTK GPS button

Tap this button to enable or disable the High-Precision RTK GPS, please refer to the corresponding chapter introduced above for more details.

About button

Tap this button to check the Product type, Vehicle ID and HOBBS Meter.

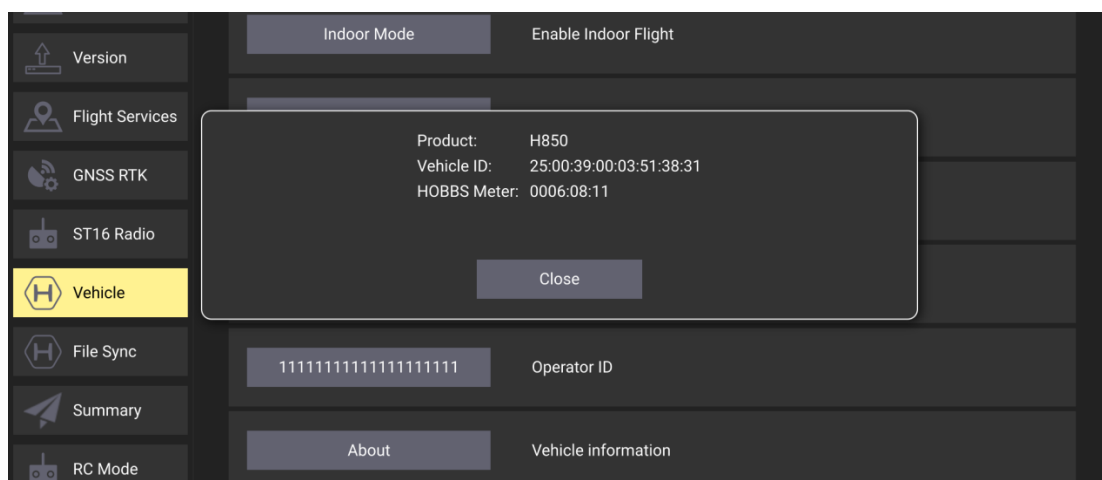

7. Summary

This item displays the summary of the settings for the vehicle.

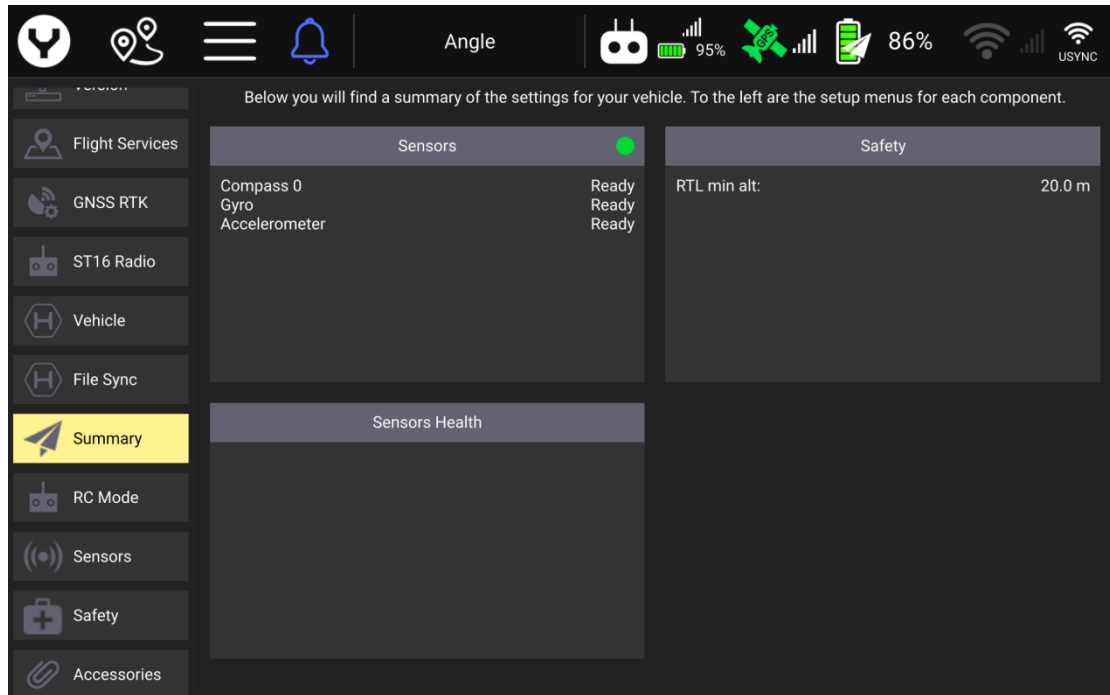

8. RC Mode

Tap to select the Joystick mode you wish to use.

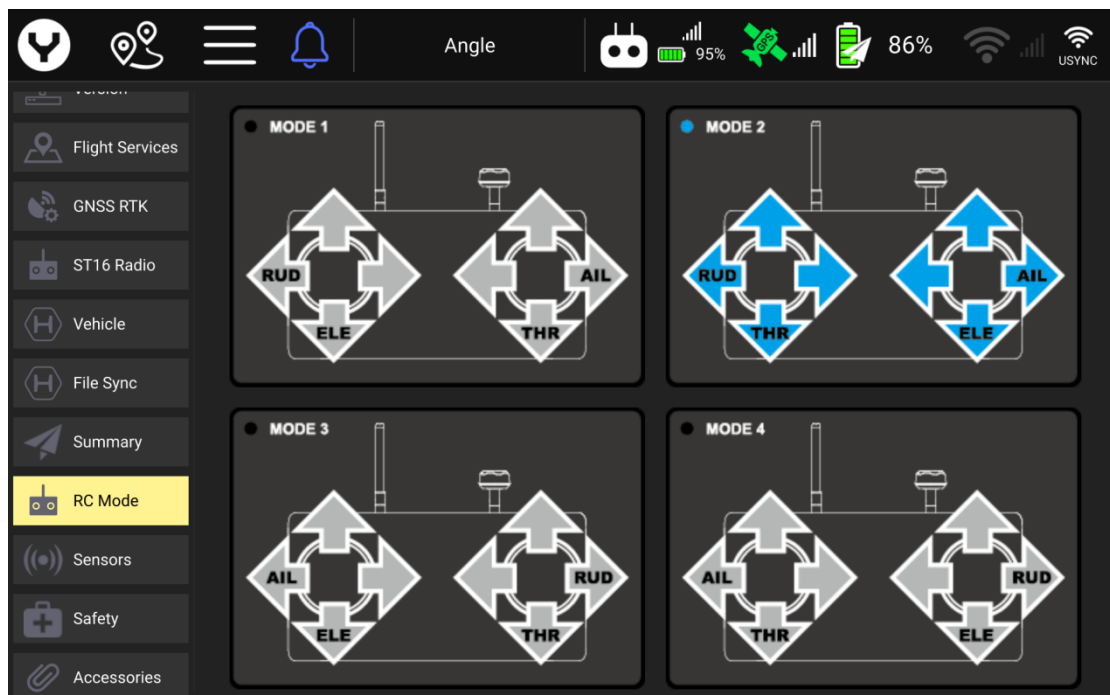

9. Sensors

The operator can check sensors status and also start the compass calibration in this interface, normally it will display a green dot beside each sensor. If the dot turns red the corresponding sensor needs to be calibrated again.

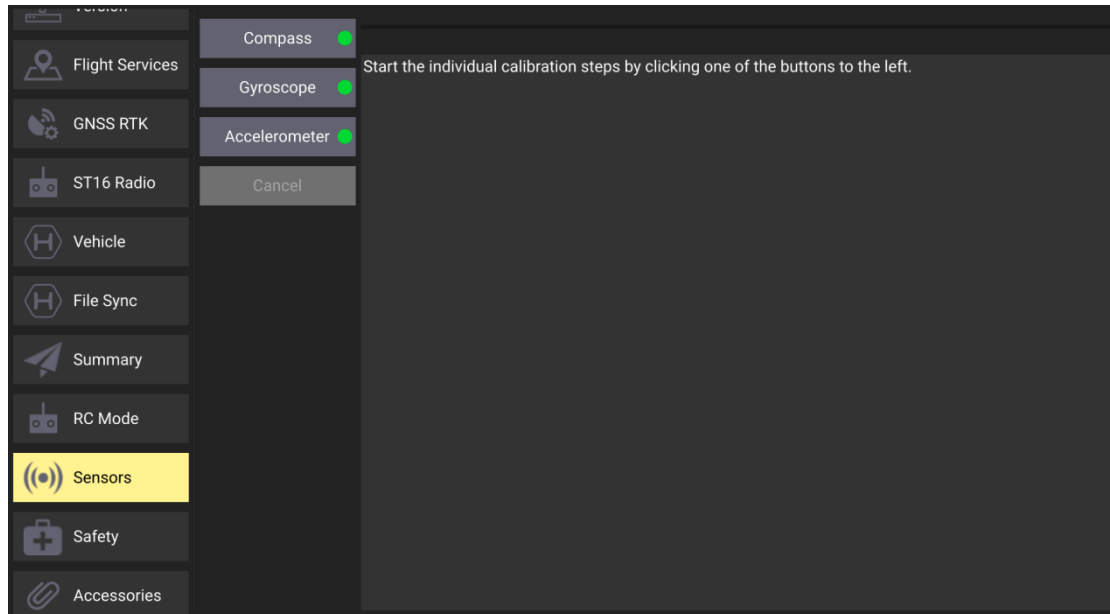

The operator can calibrate the compass by themselves, for the Gyroscope and Accelerometer we suggest to calibrate with the assistance of the nearest YUNEEC Service centre to ensure the best result.

10. Safety

The operator can change the drone fail safe behavior and geo-fence via this interface.

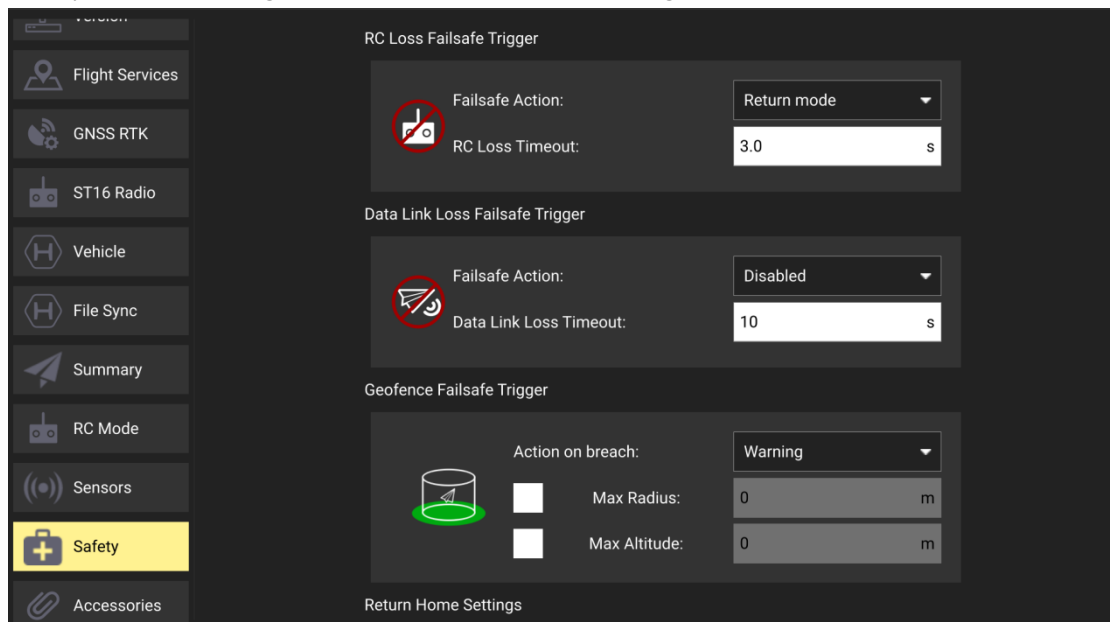

RC Loss Failsafe Trigger and Data Link Loss Failsafe Trigger

This 2 item section allows the operator to edit the drone behavior after the RC or Data Link Loss. For the H850 drone please retain the “Disable” selection for the Data Link Loss Failsafe Trigger. Only editing the RC Loss Failsafe Trigger is enough.

Tap the white arrow to open the drop-down menu then select a Failsafe behavior.

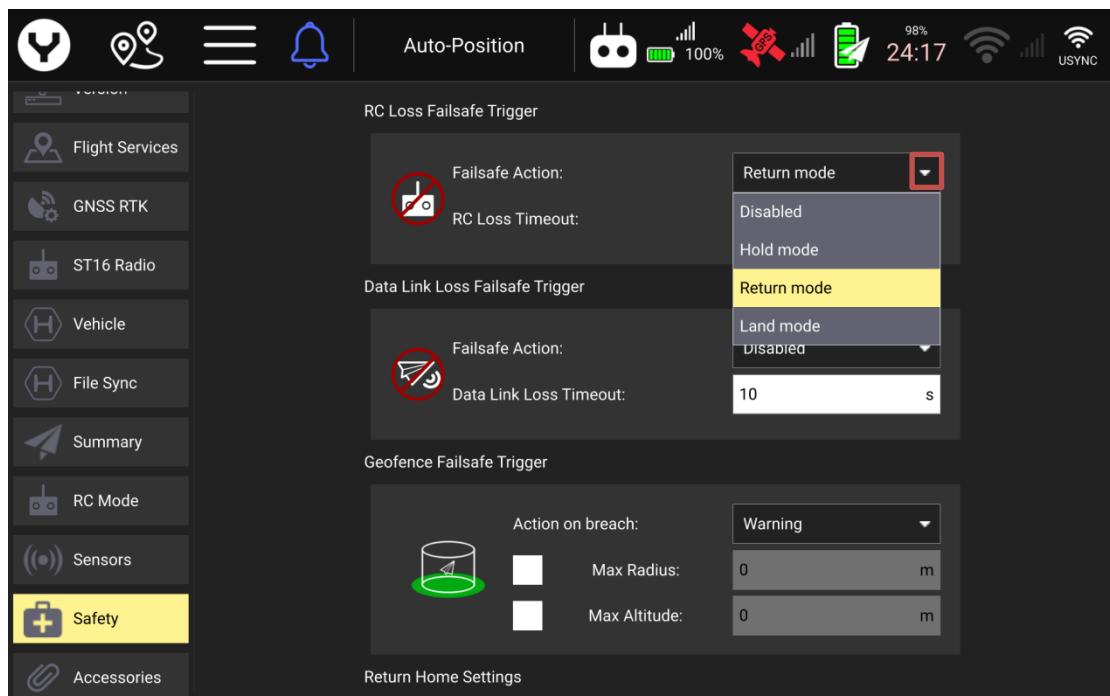

Disabled- The drone will maintain the last flight mode before the RC Loss.

Hold mode- The drone will keep hovering after the RC Loss.

Return mode-The drone will trigger the RTL mode after RC Loss.

Land mode-The drone will land directly at its current position after RC Loss.

Geofence Failsafe Trigger

The operator can set the Radius and Altitude of the Geo-fence also the drone behavior after reaching the edge of the geo-fence.

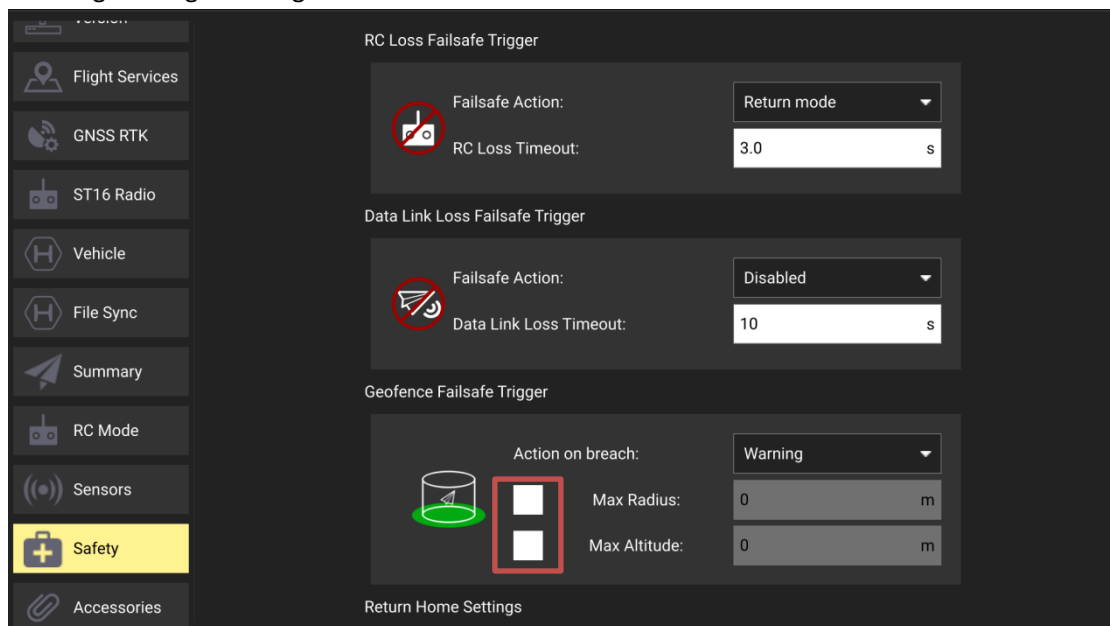

Tick the box before the Max Radius and Max Altitude to enable the Geo-fence range.

The operator can type in the parameters directly to edit the Geo-fence after the boxes are ticked.

Tap the white arrow to open the drop-down menu then select an Action on breach.

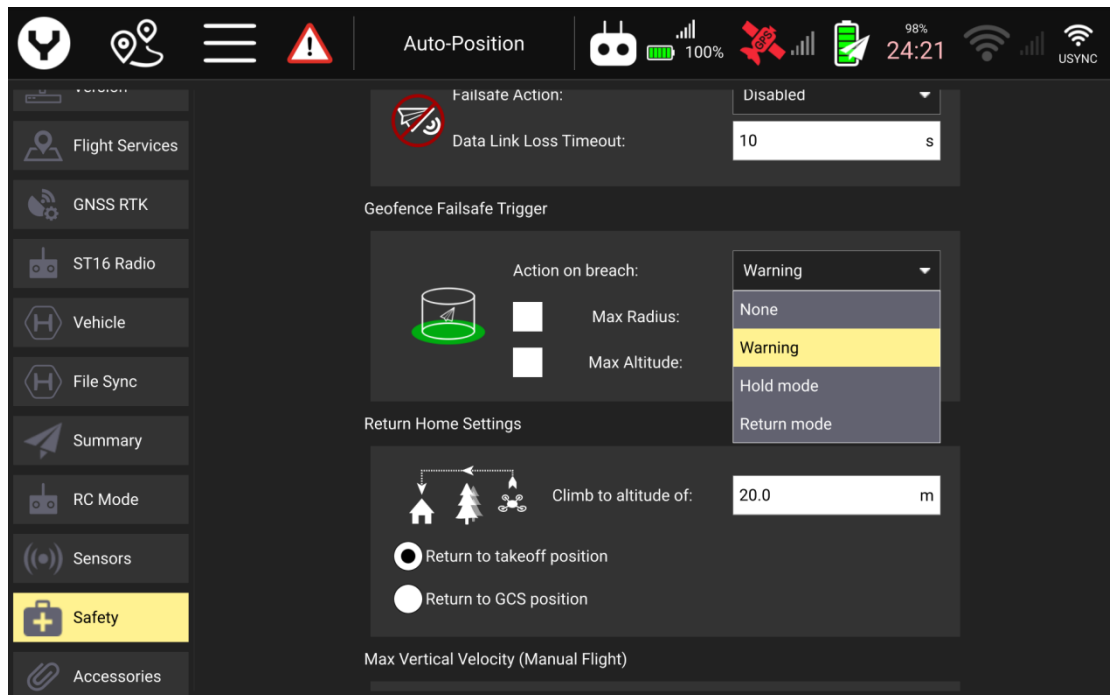

None - Although the Max Radius and Max Altitude are already set the “None” selection will still deactivate the geo fence and the drone will not react after it reaches the edge of the geo fence.

Warning- The transmitter will trigger the continuous warnings when the drone reaches or flies out of the geo fence.



Hold mode- The drone will keep hovering after it reaches the edge of the geo fence, the operator needs to switch the drone to RTL mode to control and return the drone to home.

Return mode- The drone will switch to the RTL mode automatically after reaching the edge of the geo fence.

Return Home Settings

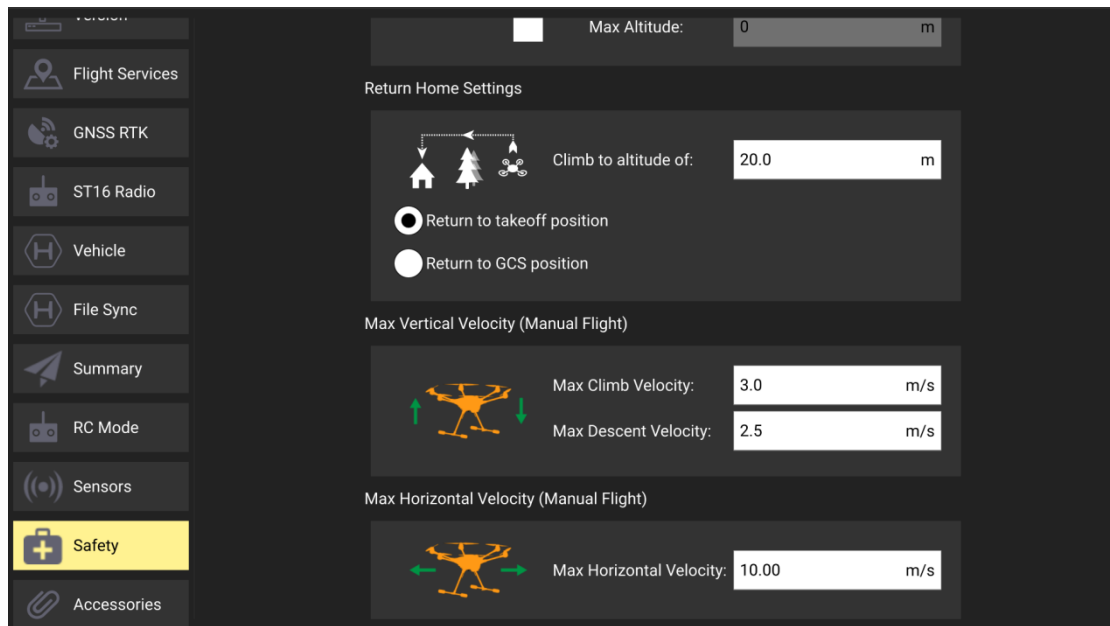

Climb to altitude of- Tap the box then type in the altitude to set a new altitude. The 20m is the default setting.

When the drone is below the altitude set after the operator enables the RTL mode the drone will climb to the RTL altitude first then flying back to the return point.

If the drone is flying higher than the RTL altitude, after the RTL enabled the drone will keep the current altitude and flying back.

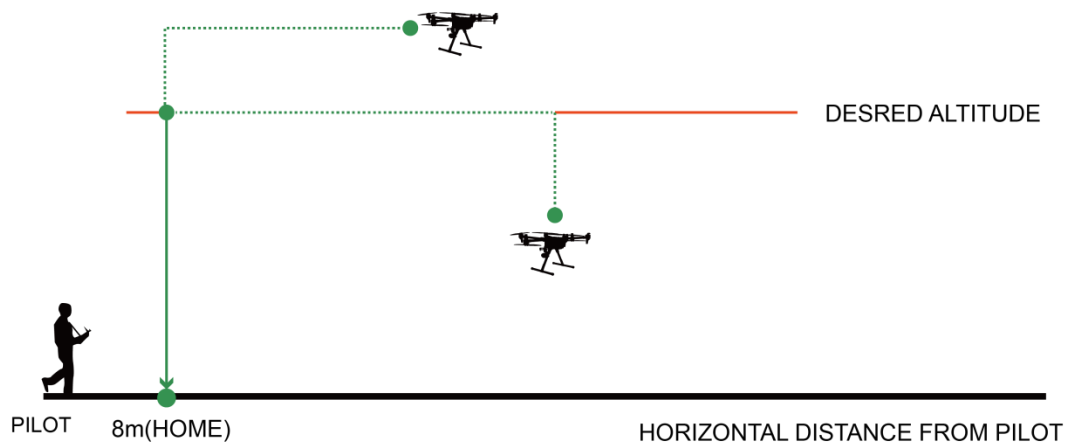

Return point setting

Tap the select dot directly to choose the return point.

If the takeoff position was selected the drone will finally land on the takeoff point in RTL mode.

If the Return to GCS position was selected the drone will land around the transmitter GPS position when the RTL mode is active.

Max Vertical and Horizontal Velocity setting

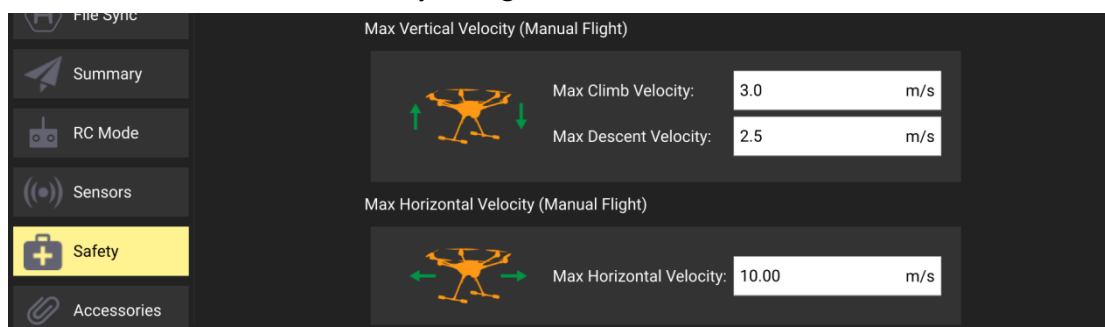

Tap the box for each items then type in the parameters to set the max climb, descent and horizontal velocity.

Notice: We do not suggest the operator to change these parameters for flight safety.

Attachment Specification

T1 Transmitter

Operating System	Android
Flight Control Software	DataPilot 2.0 App
Operating Frequency	2.400 - 2.4835 GHz 5.725 – 5.850 GHz
Transmission Protocol	2.4GHz & 5GHz
Transmission Power (EIRP)	2.4 GHz : CE<18dBm FCC <29dBm 5 GHz : CE<12dBm FCC <22dBm
Max Transmitting Distance (unobstructed, free of interference)	CE: 8km FCC: 10km
Video Output Ports	HDMI
OSD Supported	Yes
Built-in Screen Size	7"
Video Link Resolution	720P
Operating Temperature	-20°C-50°C -4° F -122° F
Battery	7.4V 10000mAh 74Wh Li-ion
USB Supply Power	5V

Drone

Type	H850
Weight	5800g (Without Camera)
Diagonal Size	850mm
Max Angular Velocity	120°/s
Max Ascend Speed	7m/s
Max Descent Speed	6m/s
Max Horizontal Speed	20m/s
Max Flight Height	500m
Max Takeoff Sea Level	5000m
Max Flight Time	60min (Without payload)
The propeller diameter	440mm
The Motor Type	BL5008
The Motor KV Value	347
Battery	LiHv 6s 12800mAh
Charger	H850 Charge Box
Recharge Time	1.5 hours
Position System	GPS+GLONASS +BeiDou+Galileo
Hovering Accuracy(Single)	Horizon:±0.5m Vertical:±0.5m
RTK(RMS) Accuracy	1cm +1ppm(H); 1.5cm+1ppm(V)
Operating Temperature	-20°C-50°C -4° F -122° F
Payload	X Connector Series Gimbals
Classification of the UA	3
Max Take off mass	8800g
Max Payload mass	3000g
Remote Controller	T1 Transmitter
Sound Power Level	95dB

- Initialization Failed : All LEDs
- Binding Completed : All LEDs
- Compass/Accelerometer/Gyro Calibration : All LEDs
- Other Status all refer to the 2 rear LEDs (LED 3#/4#)

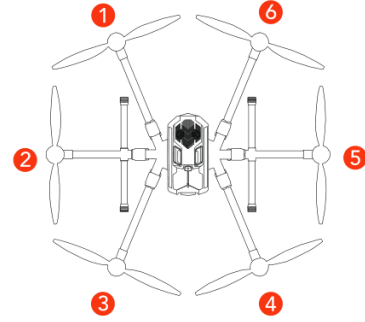

STATUS	2 5 1 6 3 4
Initiate Compass Calibration	 2 5 3 6 4 1 5 2 6 3 1 4
Accelerometer/ Gyro Calibration Completed	
During Initialization	
Calibration Failed	
The Aircraft is in Manual Mode	   
The Aircraft is in Angle Mode (without GPS lock)	   
The Aircraft is in Angle Mode (with GPS lock)	   
The Aircraft is in RTL Mode	   
The Aircraft is in SPORT Mode	   
The Aircraft is in Task Mode	   
First/Second Level Low Voltage Battery Warning	   
Compass Alarming	   

Disclaimer

Yuneec International (China) Co., Ltd shall not be held liable for any damage, injury or for use of the product in violation of legal regulations, especially in the following circumstances:

Damage and/or injury as well violation of legal regulations resulting from a failure to comply with the operating instructions or the instructions at www.yuneec.com, product information, operator manual and other legally binding information;

Damage and/or injury as well violation of legal regulations brought about by the influence of alcohol, drugs, medication or other narcotics which may impact on the concentration of the operator;

The same applies to illnesses affecting the concentration of the operator (dizziness, tiredness, nausea etc.) or other factors compromising mental and physical capabilities.

Intentionally caused damage, injury or violation of legal regulations;

Any request for compensation caused by an accident resulting from the use of the product;

Malfunction of the product caused by retrofitting or replacement with components which did not come from Yuneec;

Damage and/or injury caused by the use of replica parts (non-original parts);

Damage and/or injury as well as violation of legal regulations caused by incorrect operation or misjudgment;

Damage and/or injury caused by damaged spare parts or not using original Yuneec spare parts;

Damage and/or injury caused by unauthorized change settings and/or parameters;

Damage and/or injury caused by modifying and/or adding parts;

Damage and/or injury as well as violation of legal regulations caused by ignoring the low voltage battery warning;

Damage and/or injury caused by knowingly and negligibly flying with a damaged model or one which is unfit to fly, e.g. due to dirt, water penetration, coarse particles, oil or a model which has not been correctly or completely assembled or if the main components exhibit visible damage, defects or missing parts;

Damage and/or injury as well as violation of legal regulations caused by use of the product in a no-fly zone, e.g. next to an airfield, above a motorway or a natural conservation area;

Damage and/or injury as well as violation of legal regulations caused by operating the model in a magnetic field (e.g. high voltage lines, electricity/ transformer stations, radio towers, mobile phone masts etc.), a strong wireless signal environment, no-fly zones, poor visibility and in the event of vision impairments or other impacts on the pilot which are left unchecked etc. ;

Damage and/or injury brought about through a violation of the legal regulations for operating the model, in unsuitable weather conditions, e.g. rain, wind, snow, hail, storms, hurricanes etc. ;

Damage and/or injury as well as violation of legal regulations caused by force majeure, e.g. collision, fire, explosion, flooding, tsunami, landslide, avalanche, earthquake or other forces of nature;

Damage and/or injury as well as violation of legal regulations caused by the illegal or immoral use of the model, e.g. capturing videos or recording data which infringes upon/harms the privacy of other people;

Damage and/or injury as well as violation of legal regulations caused by incorrect use of the batteries, protection systems, chargers or aircraft;

Consequential damage caused by the incorrect operation of any kind of system components and accessory parts, especially memory cards, whereby image or video material from the camera can

become defect;

Any non-compliance with legal obligations, personal injury, material damage and environmental damage caused by use and a failure to comply with the local laws and regulations;

Damage and/or injury as well as violation of legal regulations caused by hazardous use without sufficient practical experience;

Damage and/or injury as well as violation of legal regulations caused by flying in legally defined no-fly zones.

Further losses which do not fall within the scope of use are defined by Yuneec as improper.

This product is designed for both professional use and personal private use. The national and international laws and regulations in force at the time of taking off must be adhered to.

Collection and Processing of Data

Yuneec may collect navigation information such as GPS data to help improve our products.

We may also collect Depth Map information and Infrared Image information from your drone delivered to our service centre for repair and maintenance service or any other service.

We may also collect other information such as device information, server log information, etc.

We may also collect personal information used in registration if you choose to become a registered operator and any other information operator provided to Yuneec. We may also collect information which operators send to other operators and the recipients and senders of such information.

We reserve the right to disclose your information if required to do so by law or in the good-faith belief that such disclosure is needed to comply with applicable laws, for example in response to a court order, judicial subpoena, warrant or request from the government, or otherwise cooperating with government agencies or law enforcement.

We also reserve the right to disclose your information that we believe in good faith is necessary or appropriate to: (i) protect ourselves or others from fraudulent, unlawful, or abusive activities; (ii) take precautions against potential liability; (iii) protect the security of the Yuneec Apps embedded into or downloaded onto your drone or any associated equipment and services; (iv) protect the legal rights of ourselves or any others.

Any information we collected maybe disclosed or transferred to an acquirer, successor or assignee as part of any potential merger, acquisition, debt financing or other activities that involve the transfer of business assets.

We may make the aggregated non-personal information of the s operator available to third parties for various purposes, including (i) complying with various report obligations; (ii) marketing efforts; (iii) analyzing product safety; (iv) understanding and analyzing our operators' interests, habits, usage pattern for certain functionalities, services, content, etc.

Battery Warnings and Usage Guidelines

WARNING: Lithium-ion (Li-ion) batteries are significantly more volatile than alkaline, NiCd or NiMH batteries. All instructions and warnings must be followed exactly to prevent property damage and/or serious injury as the mishandling of Li-ion batteries can result in fire. By handling, charging or using the included Li-ion battery you assume all risks associated with Li-ion batteries. If you do not agree with these conditions please return the complete product in new, unused condition to the place of purchase immediately.

You must always charge the Li-ion battery in a safe, well-ventilated area away from flammable materials.

Never charge the Li-ion battery unattended at any time. When charging the battery, you must always remain in constant observation to monitor the charging process and react immediately to any potential problems that may occur.

After flying/discharging the Li-ion battery you must allow it to cool to ambient/room temperature before recharging.

To charge the Li-ion battery you must use only the included charger or a suitably compatible Li-ion battery charger. Failure to do so may result in a fire causing property damage and/or serious injury.

If at any time the Li-ion battery begins to balloon or swell, discontinue charging or discharging immediately.

Quickly and safely disconnect the battery, then place it in a safe, open area away from flammable materials to observe it for at least 15 minutes. Continuing to charge or discharge a battery that has begun to balloon or swell can result in a fire. A battery that has ballooned or swollen even a small amount must be removed from service completely.

Do not over-discharge the Li-ion battery. Discharging the battery too low can cause damage to the battery resulting in reduced power, flight duration or failure of the battery entirely. Li-ion cells should not be discharged to below 3.0V each under load.

Store the Li-ion battery at room temperature and in a dry area for best results.

When charging, transporting or temporarily storing the Li-ion battery the temperature range should be from approximately 40–120 ° F (5–49 ° C). Do not store the battery or aircraft in a hot garage, car or in direct sunlight. If stored in a hot garage or car the battery can be damaged or even catch fire.

Never leave batteries, chargers and power supplies unattended during use.

Never attempt to charge low voltage, ballooned/swollen, damaged or wet batteries.

Never allow children less than 14 years of age to charge batteries.

Never charge a battery if any of the wire leads have been damaged or shorted.

Never attempt to disassemble the battery, charger or power supply.

Never drop batteries, chargers or power supplies.

Always inspect the battery, charger and power supply before charging.

Always ensure correct polarity before connecting batteries, chargers and power supplies.

Always disconnect the battery after charging.

Always terminate all processes if the battery, charger or power supply malfunctions.

General Safety Precautions and Warnings

WARNING: Failure to use this product in the intended manner as described in the quick start guide and instruction manual can result in damage to the product, property and/or cause serious injury.

A Radio Controlled (RC) multirotor aircraft, APV platform, drone, etc. is not a toy! If misused it can cause serious bodily harm and damage to property.

WARNING: As the operator of this product you are solely and wholly responsible for operating it in a manner that does not endanger yourself and others or result in damage to the product or the property of others.

Keep your hands, face and other parts of your body away from the spinning propellers/rotor blades and other moving parts at all times. Keep items that could impact or become entangled away from the propellers/rotor blades including debris, parts, tools, loose clothing, etc. Always operate your aircraft in open areas that are free from people, vehicles and other obstructions.

Never fly near or above crowds, airports or buildings.

To ensure proper operation and safe flight performance never attempt to operate your aircraft nearby buildings or other obstructions that do not offer a clear view of the sky and can restrict GPS reception.

Do not attempt to operate your aircraft in areas with potential magnetic and/or radio interference including areas nearby broadcast towers, power transmission stations, high voltage power lines, etc.

Always keep a safe distance in all directions around your aircraft to avoid collisions and/or injury. This aircraft is controlled by a radio signal subject to interference from many sources outside your control.

Interference can cause momentary loss of control.

To ensure proper and safe operation of the automatic landing function in Return Home Mode you must start the motors with the aircraft in an open space and achieve a proper GPS lock.

Do not attempt to operate your aircraft with any worn and/or damaged components, parts, etc. including, but not limited to, damaged propellers/rotor blades, old batteries, etc.

Never operate your aircraft in poor or severe weather conditions including heavy winds, precipitation, lightning, etc.

Always begin to operate your aircraft with a fully charged battery. Always land as soon as possible after the first level low voltage battery warning or land immediately after the second level low voltage battery warning.

Always operate your aircraft when the voltage of the battery in the transmitter/personal ground station is in a safe range (as indicated by the LED status indicator light of the transmitter/personal ground station).

Always keep the aircraft in a clear line of sight and under control, and keep the transmitter/personal ground station powered on while the aircraft is powered on.

Always move the throttle control stick down fully and turn off the power in the event the propellers/ rotor blades come into contact with any objects.

Always allow components and parts to cool after use before touching them and flying again.

Always remove batteries after use and store/transport them per the corresponding guidelines.

Avoid water exposure to all electronic components, parts, etc. not specifically designed and protected for use in water. Moisture causes damage to electronic components and parts.

Never place any portion of the aircraft or any related accessories, components or parts in your mouth as doing so could cause serious injury or even death.

Always keep chemicals, small parts and electronic components out of the reach of children.

To ensure safe fly, it is recommended to install the propeller protectors when operating the aircraft indoors or nearby crowds.

Carefully follow the instructions and warnings included with this aircraft and any related accessories, components or parts (including, but not limited to, chargers, rechargeable batteries, etc.).

FCC Statement

This equipment has been tested and found to comply with the limits for Part 15 of the FCC rules. These limits are designed to provide reasonable protection against harmful interference in a residential installation. This equipment generates, uses and can radiate radio frequency energy and, if not installed and used in accordance with the instructions, may cause harmful interference to radio communications.

However, there is no guarantee that interference will not occur in a particular installation.

If this equipment does cause harmful interference to radio or television reception, which can be determined by turning the equipment off and on, the operator is encouraged to try to correct the interference by one or more of the following measures:

- Reorient or relocate the receiving antenna.
- Increase the separation between the equipment and receiver.
- Connect the equipment to an outlet on a circuit different from that to which the receiver is connected.
- Consult the dealer or an experienced radio/TV technician for help.

This device complies with part 15 of the FCC rules. Operation is subject to the following two conditions:

This device may not cause harmful interference, and (2) this device must accept any interference received, including interference that may cause undesired operation.

RF Exposure Warning

This equipment must be installed and operated in accordance with provided instructions and the antenna(s) used for this transmitter must be installed to provide a separation distance of at least 20 cm from all persons and must not be co-located or operating in conjunction with any other antenna or transmitter. End-operators and installers must be provided with antenna installation instructions and transmitter operating conditions for satisfying RF exposure compliance.

IC Radiation Exposure Statement for Canada

This device complies with Industry Canada license-exempt RSS standard (s). Operation is subject to the following two conditions: (1) this device may not cause interference, and (2) this device must accept any interference, including interference that may cause undesired operation of the device. Le présent appareil est conforme aux CNR d'Industrie Canada applicables aux appareils radio exempts de licence. L'exploitation est autorisée aux deux conditions suivantes : (1) l'appareil ne doit pas produire de brouillage, et (2) l'utilisateur de l'appareil doit accepter tout brouillage radioélectrique subi, même si le brouillage est susceptible d'en compromettre le fonctionnement.

This equipment complies with IC RSS-102 radiation exposure limit set forth for an uncontrolled environment. Cet équipement respecte les limites d'exposition aux rayonnements IC définies pour un environnement non contrôlé.

CE WARNING STATEMENT

This device meets the EU requirements on the limitation of the general public to electromagnetic fields by way of health protection.

EU Operation Frequency (The Maximum Transmitted Power)

T1 Transmitter:

2.4G: 2400-2438.5MHz (18dBm);

5G: 5725-5850MHz (12dBm);

2.4G Wi-Fi: 2400-2438.5MHz (18dBm);

5G Wi-Fi: 5725-5850MHz (12dBm);

H850:

2.4G: 2400-2438.5MHz (18dBm);

5G: 5725-5850MHz (12dBm).

EU COMPLIANCE STATEMENT

Hereby, Yuneec International (China) Co., Ltd. declares that this device is in compliance with the essential requirements and other relevant provisions of the RED Directive 2014/53/EU.

The full text of the EU Declaration of Conformity is available at the following internet address:

www.yuneec.com please visit the address above and enter into the corresponding product page.

H850



Yuneeec Support

www.yuneeec.com

This content is subject to change downloads the latest version from www.yuneeec.com

If you have any questions about this document, please contact us by starting a conversation on www.yuneeec.com