

# SmartCell

*Intelligent Wireless Zone Monitor*

## Quick Start Guide

# Contents

|                                 |    |                            |    |
|---------------------------------|----|----------------------------|----|
| Introduction                    | 3  | Set time & date            | 17 |
| Important notes                 | 3  | Install devices            | 18 |
| Additional documentation        | 4  | Add devices to system      | 19 |
| Overview of system setup        | 5  | Device attributes          | 20 |
| What's in the box               | 7  | Device location text       | 22 |
| WZM features                    | 8  | Text entry                 | 23 |
| Side cover removal              | 8  | Set the panel type         | 24 |
| Open WZM                        | 9  | Sounder tones              | 25 |
| Optional door removal           | 9  | Sounder duration           | 27 |
| Cable entry                     | 10 | Sounder activation method  | 28 |
| Fix WZM to wall                 | 10 | Pulsed output              | 29 |
| Addressable fire system wiring  | 11 | Device indicator operation | 31 |
| Conventional fire system wiring | 12 | Device signal levels       | 32 |
| Mains power connections         | 13 | Test devices               | 33 |
| 24 VDC power connections        | 13 | Congratulations            | 36 |
| Re-fit door                     | 14 |                            |    |
| Connect backup battery          | 14 |                            |    |
| Remove 3V battery tab           | 15 |                            |    |
| Apply power                     | 15 |                            |    |
| Engineer menu entry             | 16 |                            |    |

# Introduction

This quick start guide will show you how to set up the SmartCell Wireless Zone Monitor (WZM), for connection to either addressable or conventional fire alarm systems. For advanced programming, refer to the 'SmartCell Wireless Zone Monitor Programming Guide' (MK067).

Note: this quick start guide will cover the method of adding devices via power-up. Refer to the programming guide for more information of alternative methods.

## Important notes



The installation must conform to applicable local installation codes and should only be installed by a fully trained competent person.



Always select an appropriate device type for the application as per local codes of practice, or as advised by a qualified professional.



The procedures outlined in this installation guide must be carefully followed.



SmartCell devices contain electronics that may be susceptible to damage from Electro Static Discharge (ESD). Take appropriate precautions when handling electronic boards.

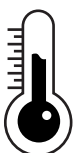

To ensure correct operation, products must be used within the specified environmental operating conditions.

# Additional documentation

The below QR codes provide links to the a wide range of WZM information, including:

- Wireless Zone Monitor Programming Guide (*MK067*)
- Wireless Zone Monitor Installation Guide (*TSD127*)
- Wireless Zone Monitor Datasheet
- Wireless Zone Monitor certification



Wireless Zone Monitor  
(230 VAC version):

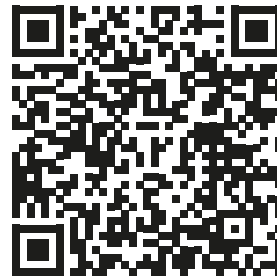

Wireless Zone Monitor  
(24 VDC version):

Note: Should you be unable to scan the QR code, visit the following website addresses:

Wireless Zone Monitor (230 VAC version):

[https://firesecurityproducts.com/en/product/fire/SC\\_13\\_1100\\_0001\\_99/83586](https://firesecurityproducts.com/en/product/fire/SC_13_1100_0001_99/83586)

Wireless Zone Monitor (24 VDC version):

[https://firesecurityproducts.com/en/product/fire/SC\\_13\\_2100\\_0001\\_99/83591](https://firesecurityproducts.com/en/product/fire/SC_13_2100_0001_99/83591)

# Overview of system setup

## Step 1

Install the SmartCell WZM.

## Step 2

Log on devices required for the installation - Smoke detectors, heat detectors, call points, sounders and input / output devices, etc.

Enter device location text.

Note: If devices and zones are not programmed with custom text labelling, default text will be displayed. E.g.

```
Z01 A04          TAMPER  
Sounder Detector  
ID:001234  
View>
```

*Example device fault with default device text:*

## Step 3

Change device default settings if required in accordance with local codes of practice, or as professionally advised.

## Step 4

Set the WZM to match the connected fire control panel type (*either conventional or addressable*).

## Step 5

Configure sounder tones, durations and activation methods.

## **Step 6**

Check all device signal levels are stated as 'GOOD'.

## **Step 7**

Test every device for correct operation, using appropriate test equipment.

Note: sounders may activate upon activation of a wireless device if the 'Sounder activation method' is set to 'Immediate'.

## **Step 8**

Weekly test the system in accordance with local codes of practice.

## **Step 9**

Maintain the system in accordance with local codes of practice and manufacturers recommendations.

# What's in the box

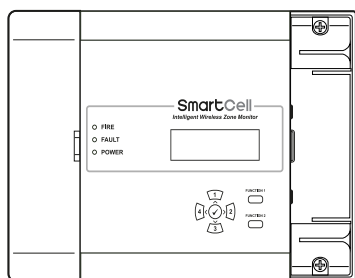

SmartCell  
WZM

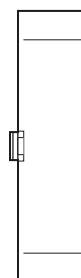

Right hand  
side cover

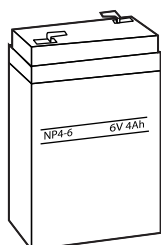

6V 4Ah  
battery

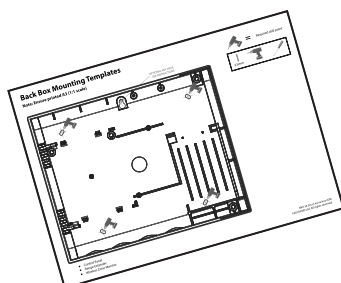

WZM fixing  
template

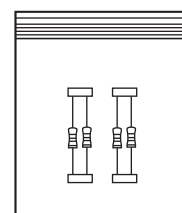

Resistor  
pack

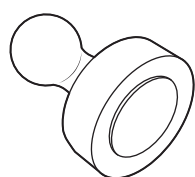

Log on  
magnet



Allen  
key

# WZM features

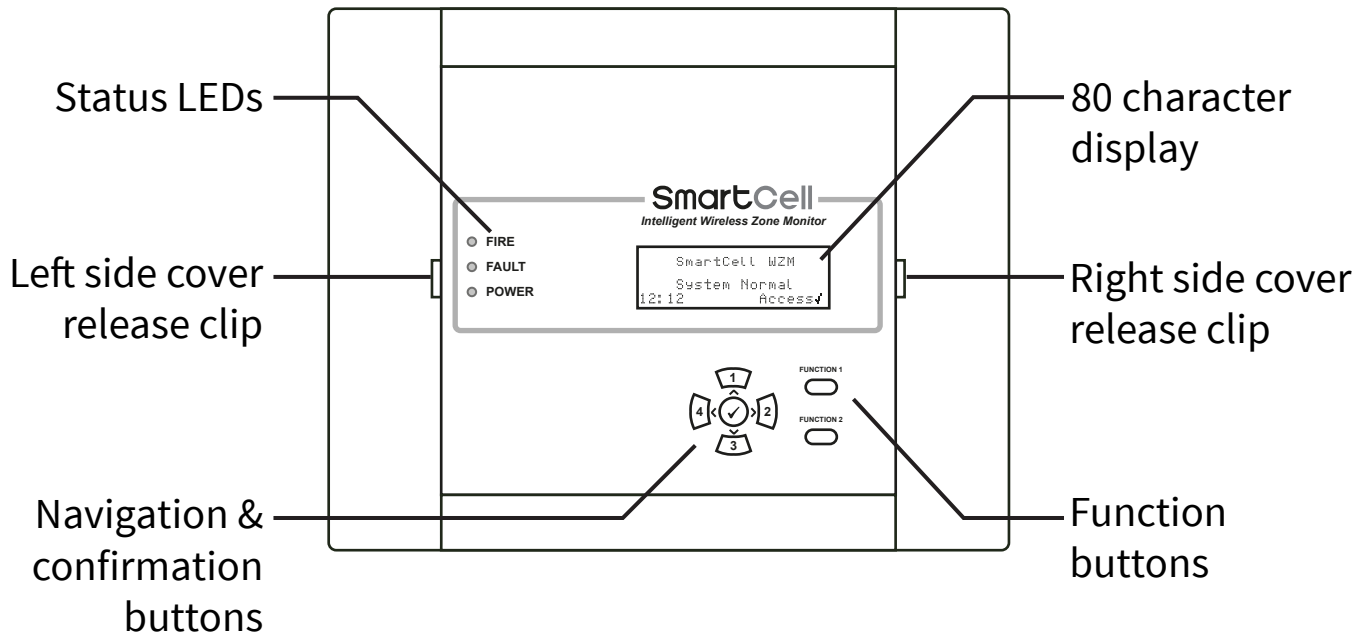

## Side cover removal

The following steps illustrate how to remove the side covers:

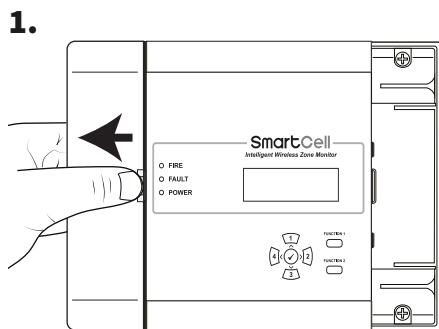

Slide the side cover sideways, creating a gap as shown.

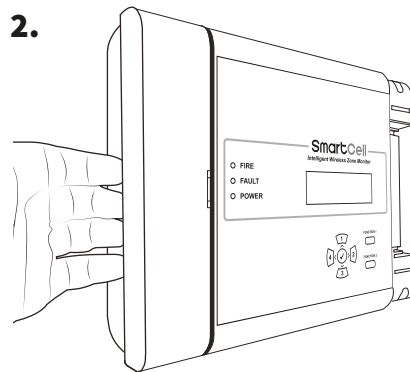

Position your fingers behind the cover's protruding edge.

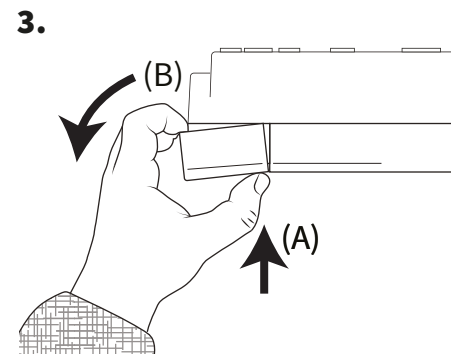

Press the cover's releasing clip with your thumb (A), and simultaneously rotate the side cover anti-clockwise (B), as viewed overhead to remove the cover.



# Open WZM

1. Unclip side cover.

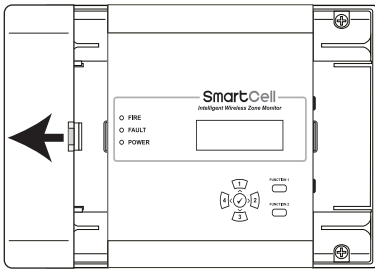

2. Loosen screws.

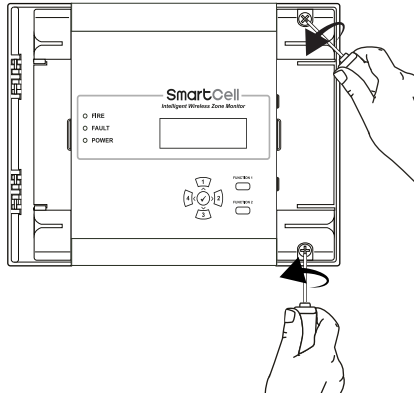

3. Open door.

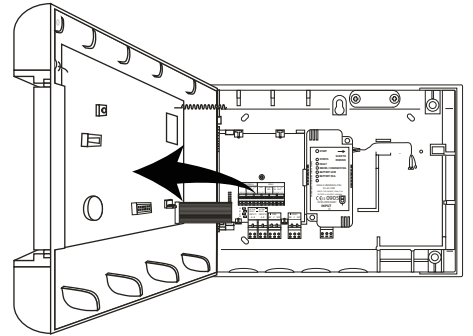

Refer to the 'Side cover removal' section (page 8) for details.

*230 VAC variant shown*

## Optional door removal

Disconnect the ribbon cable, then turn and release the door hinges.

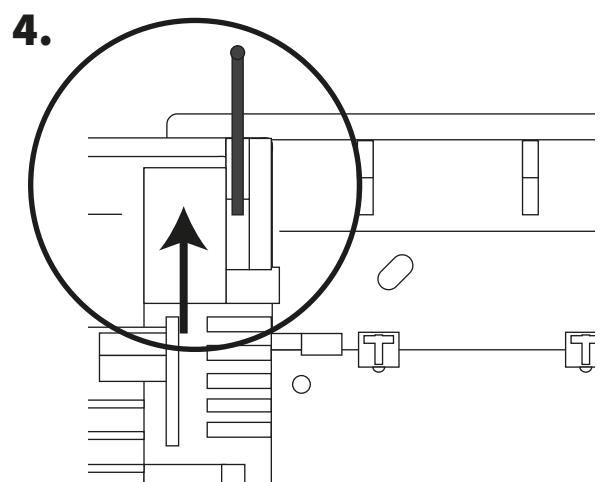
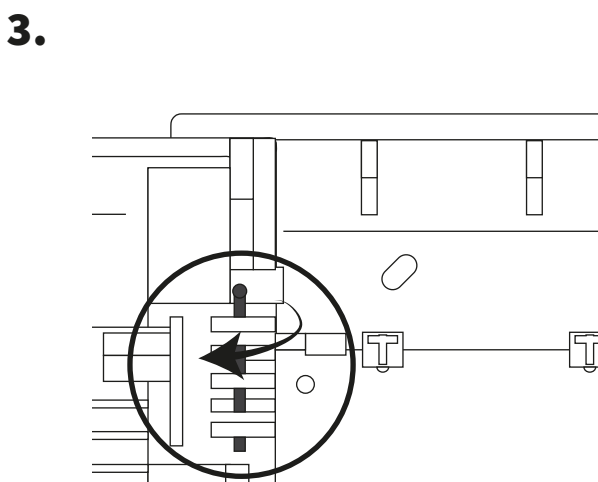
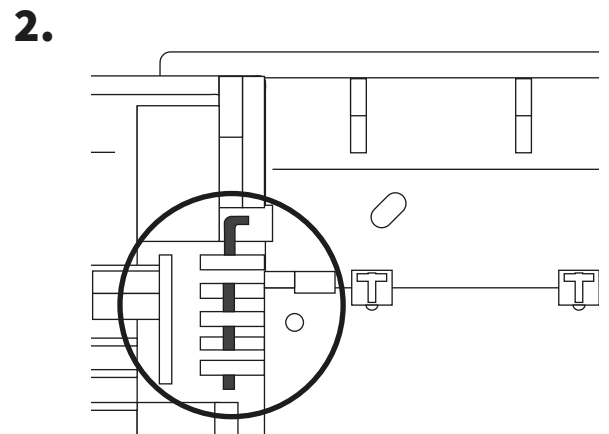
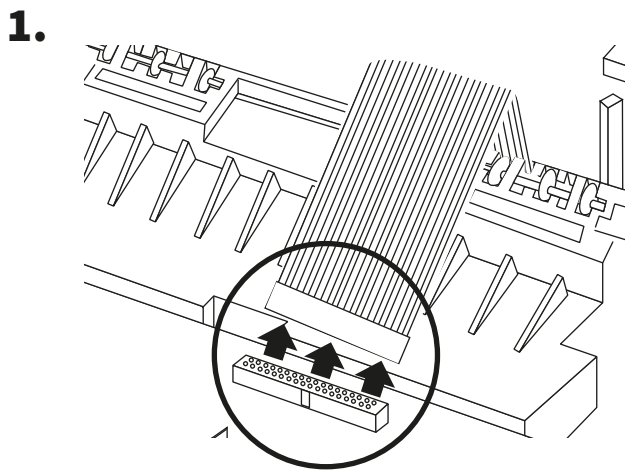

# Cable entry

Select cable entry points as required, before fitting to the wall.

Rear side view

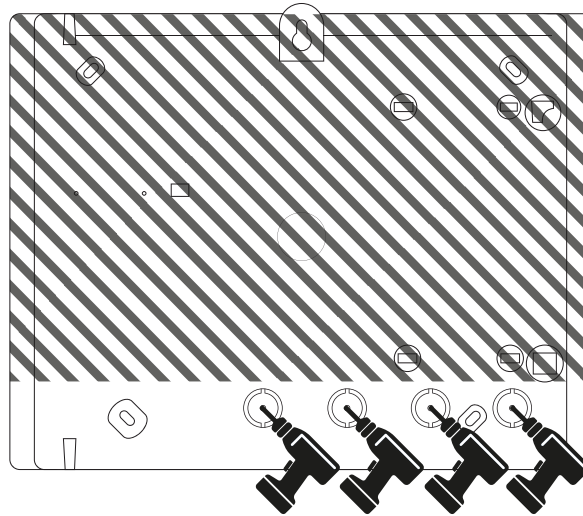

**NO CABLE ACCESS  
AT THE TOP OF  
THE UNIT!**

 = Available entry point

Under side view

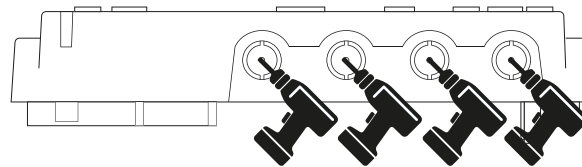

# Fix WZM to wall

Key hole

Spirit level

Fixing positions

Fixing positions

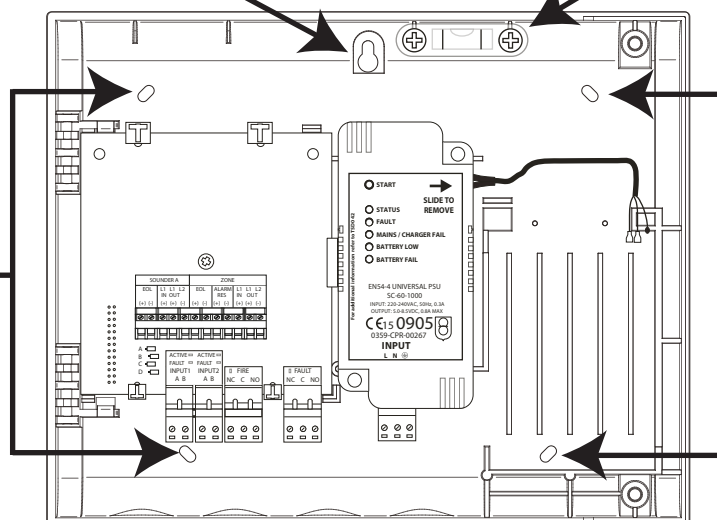

Note: the supplied back box mounting template can be used to drill the fixing positions.

# Addressable fire system wiring

- SKIP THIS STEP IF CONNECTING TO A CONVENTIONAL FIRE SYSTEM.
- Wire the inputs as shown below, using the resistor pack provided.
- If an input is not being used, leave the 20 kΩ resistor as factory fitted.
- Both outputs are voltage free and rated 30 V @ 1 A.
- The maximum cable length to connected devices is 10 m.

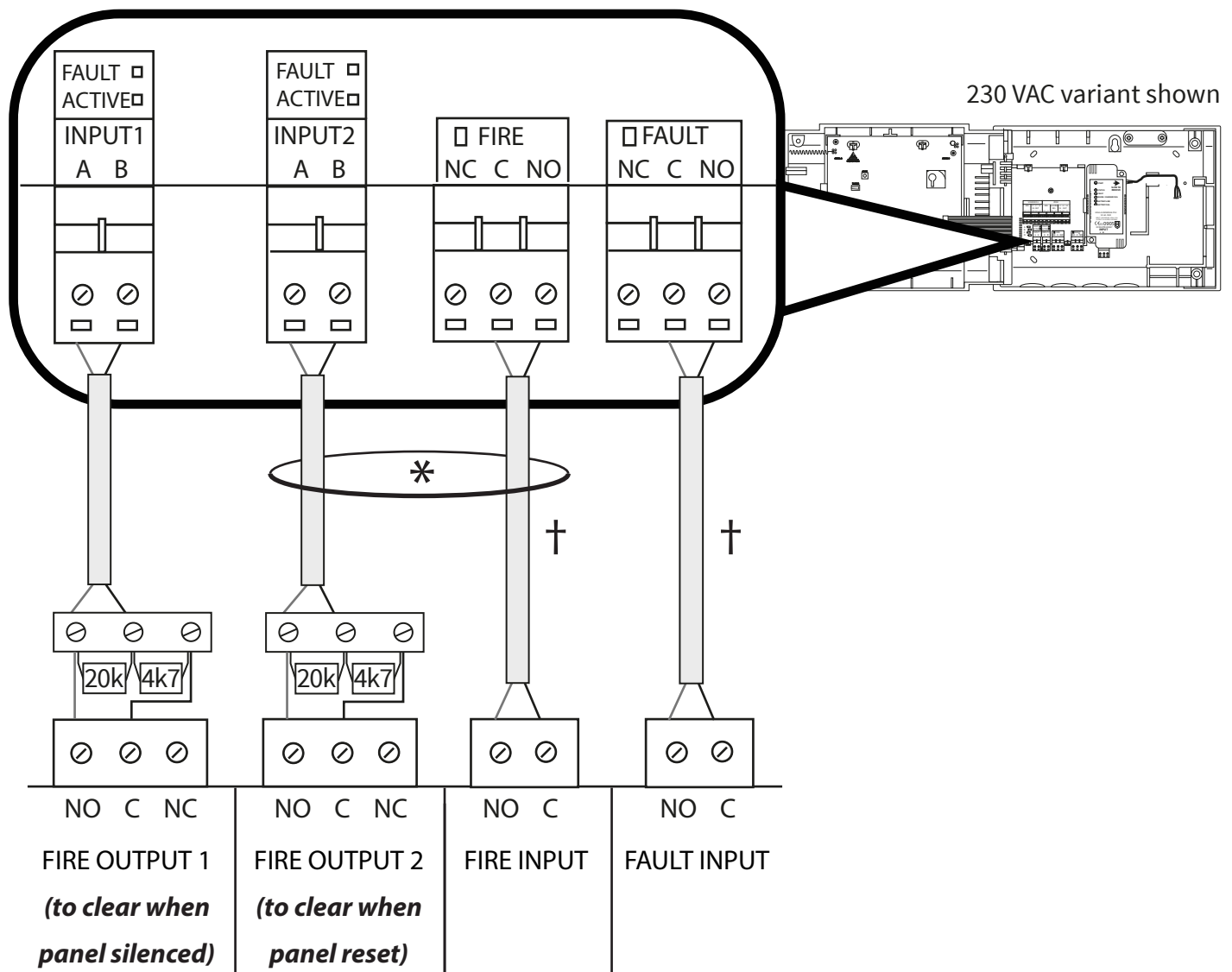

*Addressable fire system connections*

## FOOTNOTES

- \* Optional cabling, required only when the following SmartCell devices are added to the WZM; detectors, call points and I/O Units (*I/O units when set to 'Off When Reset'*) - see page 31 for details on this feature.
- † Wiring can be normally open or normally closed operation as required.

# Conventional fire system wiring

- SKIP THIS STEP IF CONNECTING TO AN ADDRESSABLE FIRE SYSTEM.
- The WZM must be connected to a dedicated zone and sounder output.
- The maximum cable length to connected devices is 10 m.

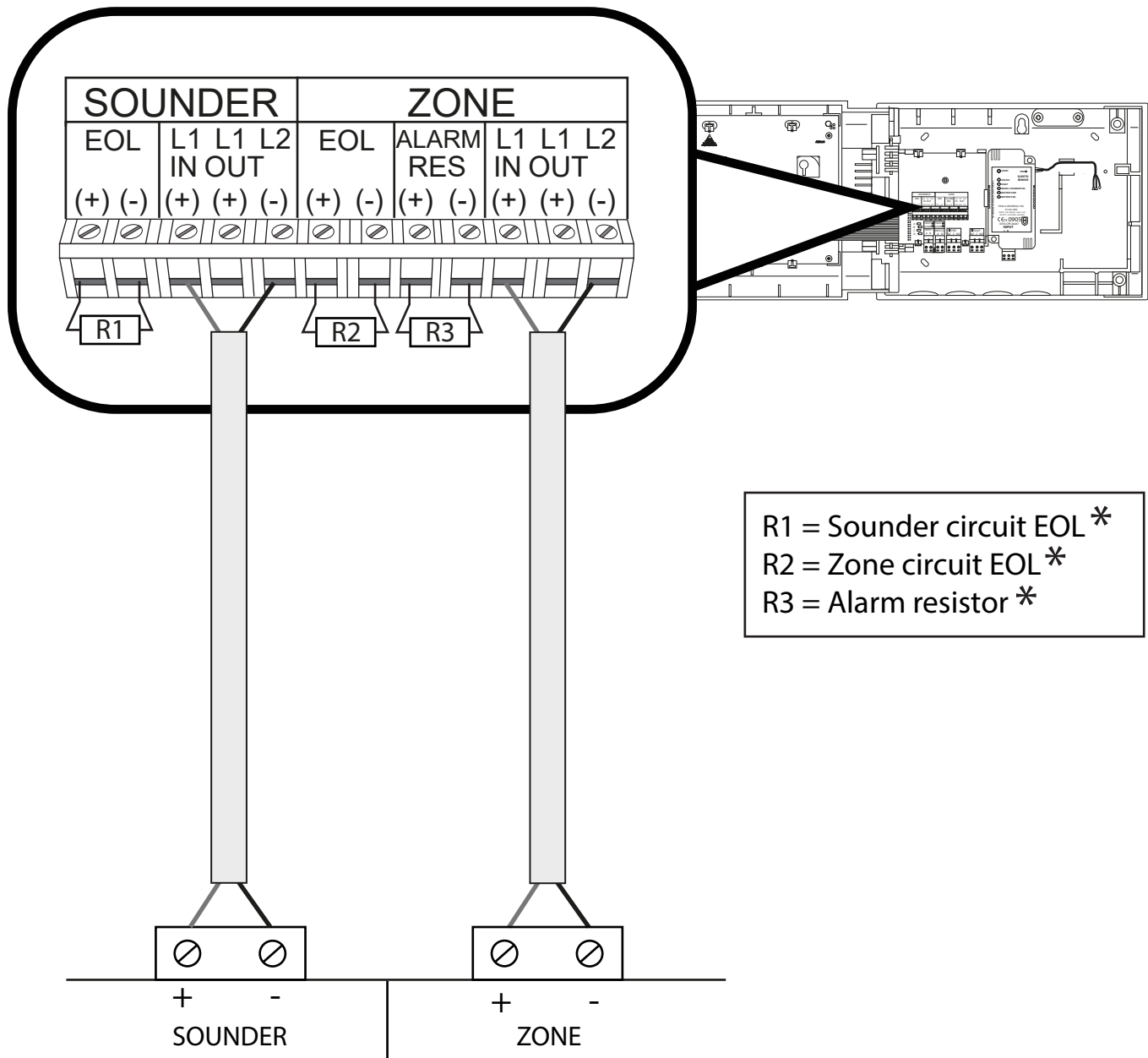

*Conventional fire system connections*

## FOOTNOTES

- \* Ensure that the manufacturer's specified end of line components and triggering resistors are fitted. See the control panel's instructions for more information.

# Mains power connections

230 VAC WZMs only.

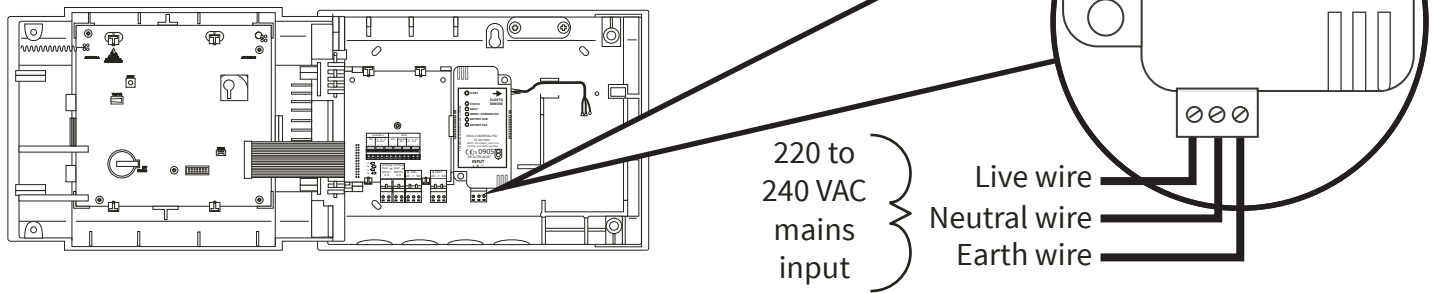

# 24 VDC power connections

24 VDC WZMs only.

The 24 VDC SmartCell WZM is designed to be powered from 2x 24 VDC power sources, to meet country specific requirements.

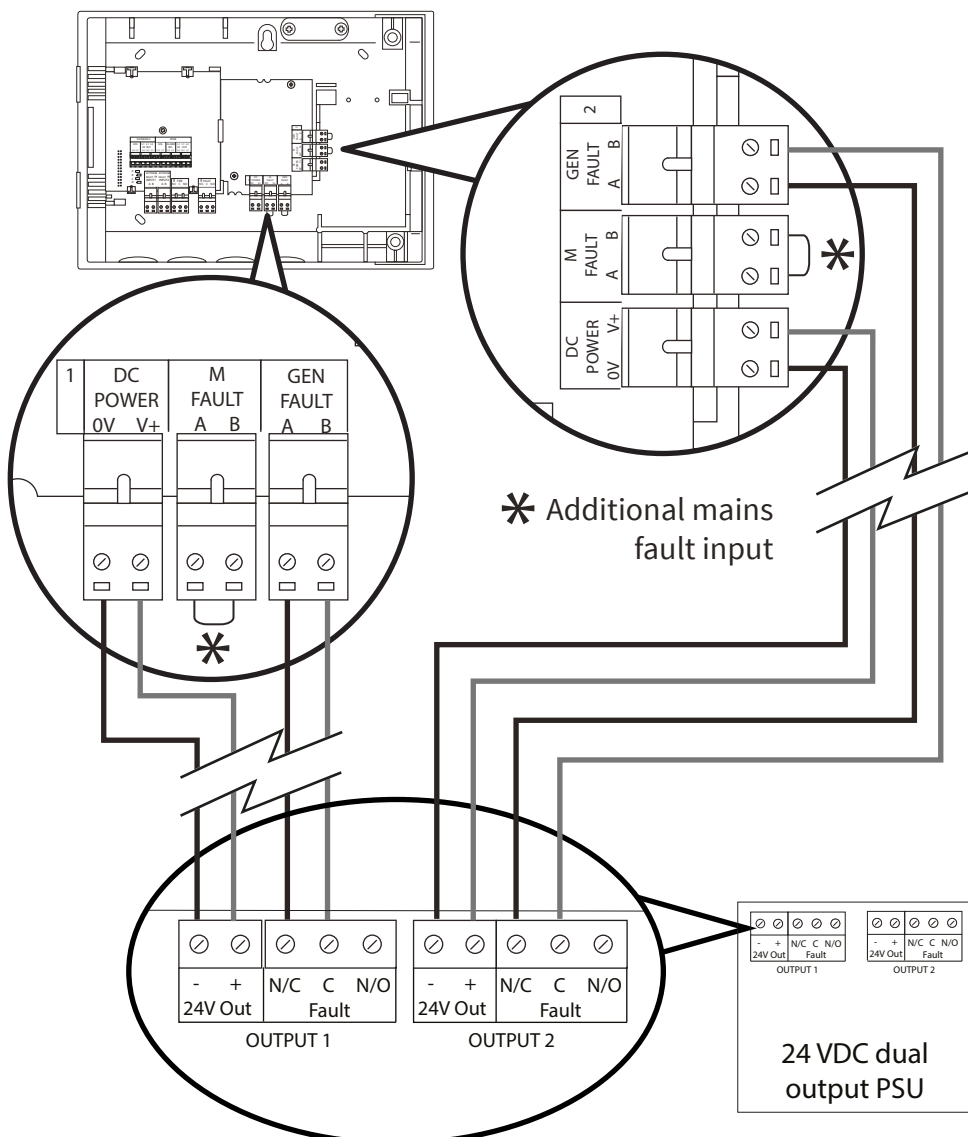

- Connect both power inputs.
- There are also general fault inputs (GEN FAULT) and mains fault (M FAULT) available.
- The fault inputs are NC and voltage free.
- If a fault input (GEN FAULT or M FAULT) is not being used, leave the link as factory fitted.

# Re-fit door

Re-connect the ribbon cable and re-fit the door hinges.

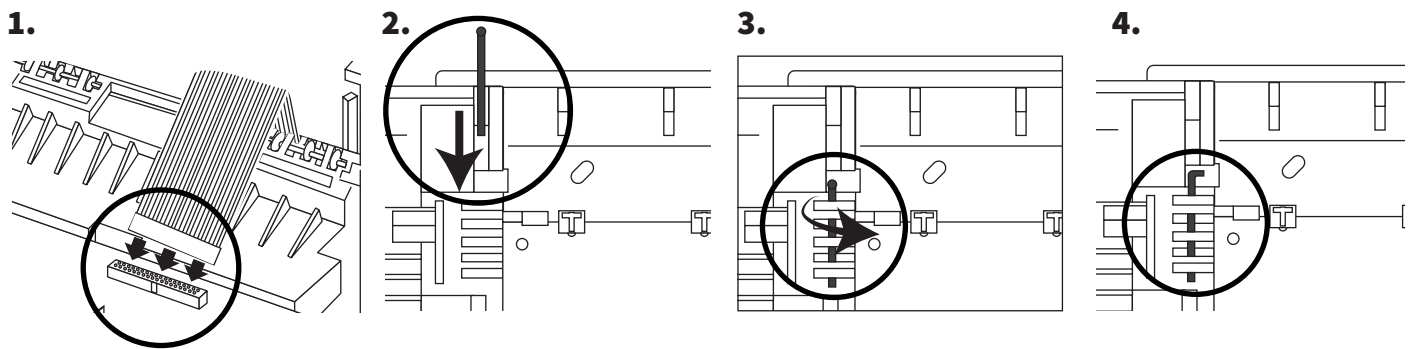

# Connect backup battery.

*230 VAC WZMs only.*

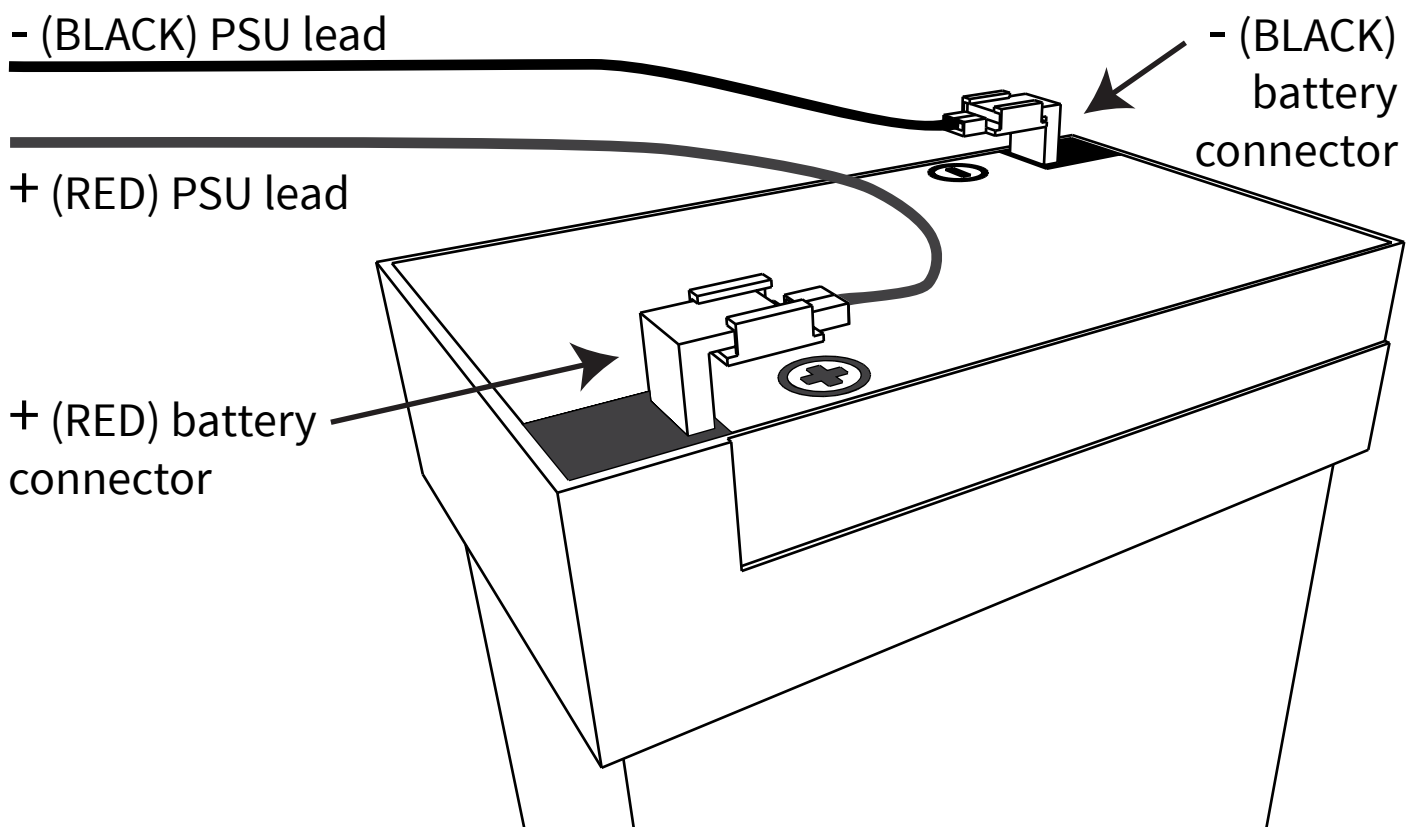

# Remove 3V battery tab.

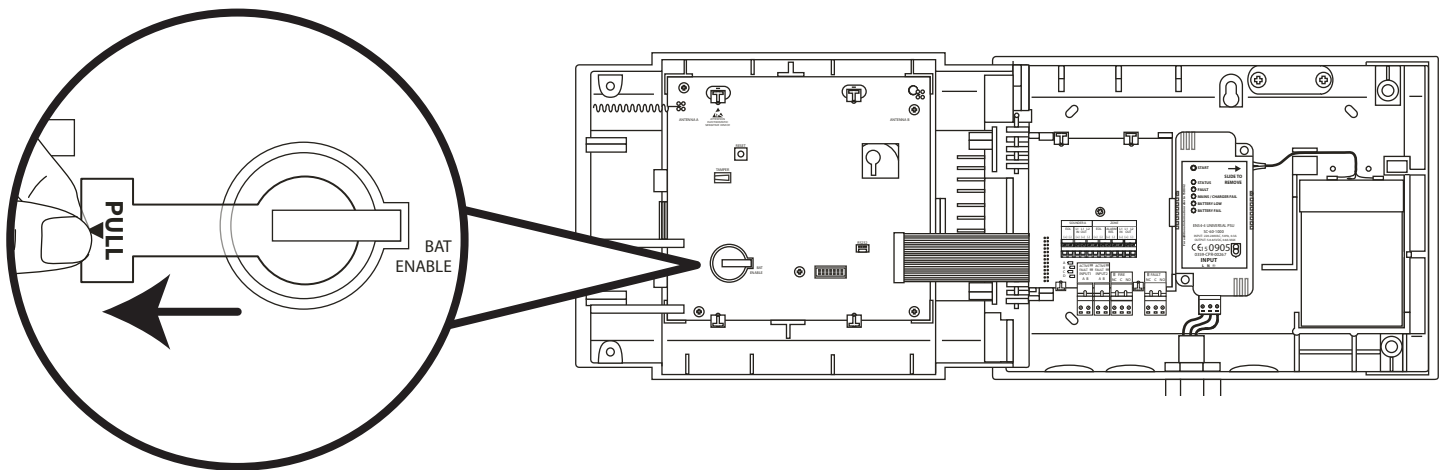

# Apply power

The power supply to the WZM can now be switched on.

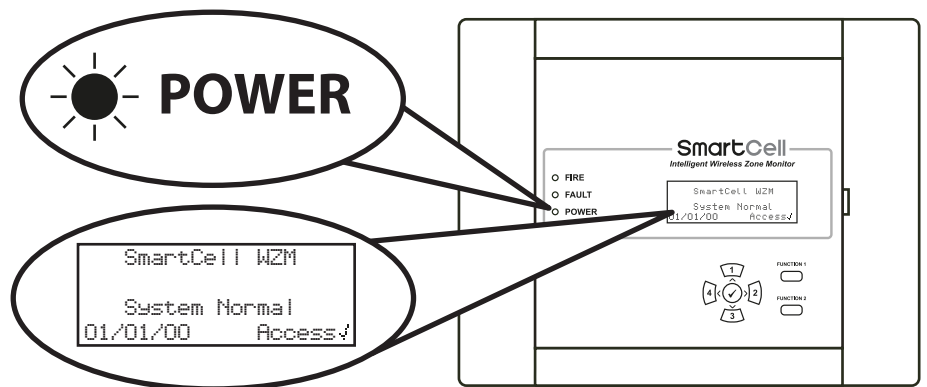

Note: If mains supply is unavailable at this point, the WZM can be temporarily powered by the back-up battery.

To achieve this, simply press the PSU's 'START' button.

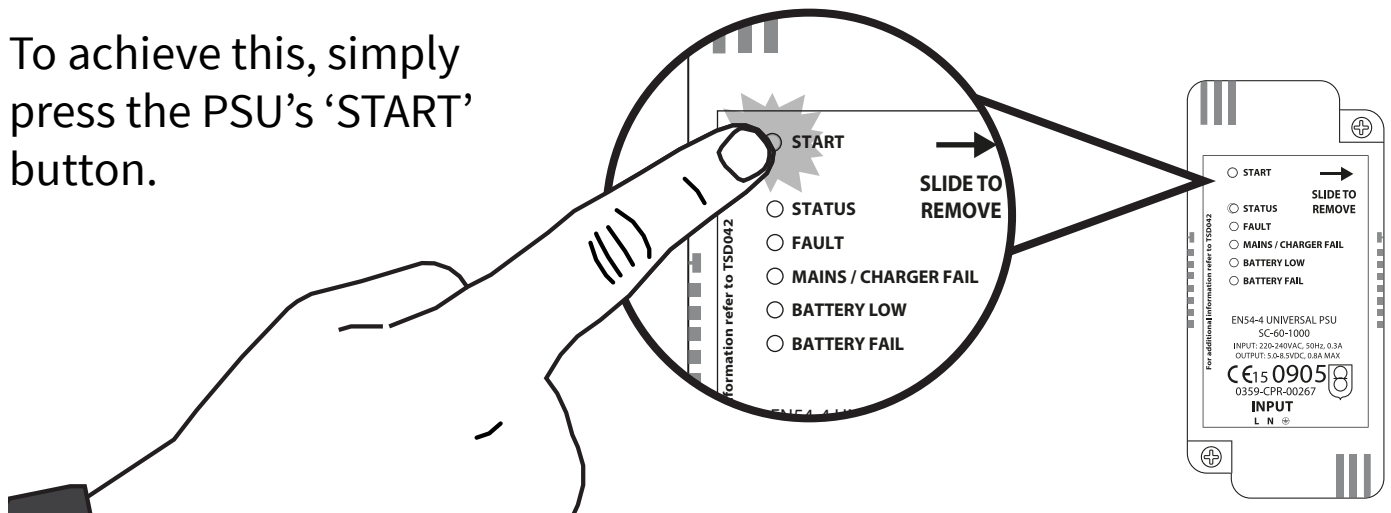

# Engineer menu entry

The following steps are required to access the engineer menu (*access level 3*).

With the SmartCell WZM in its normal state the screen will display:

```
SmartCell WZM  
  
System Normal  
14:18 Access✓
```

Press the  button and the screen will display:

```
For Access  
Enter Code: _  
  
Press ✓ To Complete
```

Enter the engineer PIN code (*default '333333'*), then press the  button to confirm. The screen will display:

```
* Welcome Service *  
Access Level 3  
Now Available  
All Buttons Active
```

Followed by:

```
*View System Status  
Maintenance/Test  
Device Options  
WZM Settinas ◁
```

All engineer menus are now available. You can now:

- Set the time & date
- Configure the WZM
- Program devices to the system
- Enter device text
- Configure devices, i.e. device sensitivities, sounder tones etc.



# Set time & date

From access level 3 (*as previously shown on page 16*), press the  button until the screen displays:

```

→WZM Information
  Language Select
  Factory Access
  Reports
  
```

Press the  button and the screen will display:

```

→Edit Users
  WZM Options
  System Options
  Communications
  
```

Press the  button once. The screen will display:

```

  Edit Users
→WZM Options
  System Options
  Communication
  
```

Press the  button and the screen will display:

```

→Set Time & Date
  Lamp/Buzzer Test
  Front Screen Text
  WZM LED Disable
  
```

Press the  button and the screen will display:

```





→?:?:??          TIME
  ??/??/??       DATE
  DD/MM/YY       FORMAT
  Press √ To Select
  
```

To change the time, press the  button and the screen will display:  
*The following buttons are required to set the time:*

```

→?:?:??          TIME

  Edit ◊          √ To Select
  
```

| Button(s)   | Action   |
|---|--|
|   | Increases and decreases the selected value.              |
|   | Moves the cursor between the hour and minute selections. |
|    | Saves the changes and returns to the previous screen.    |



Note: the same process is used for changing the date.

# Install devices

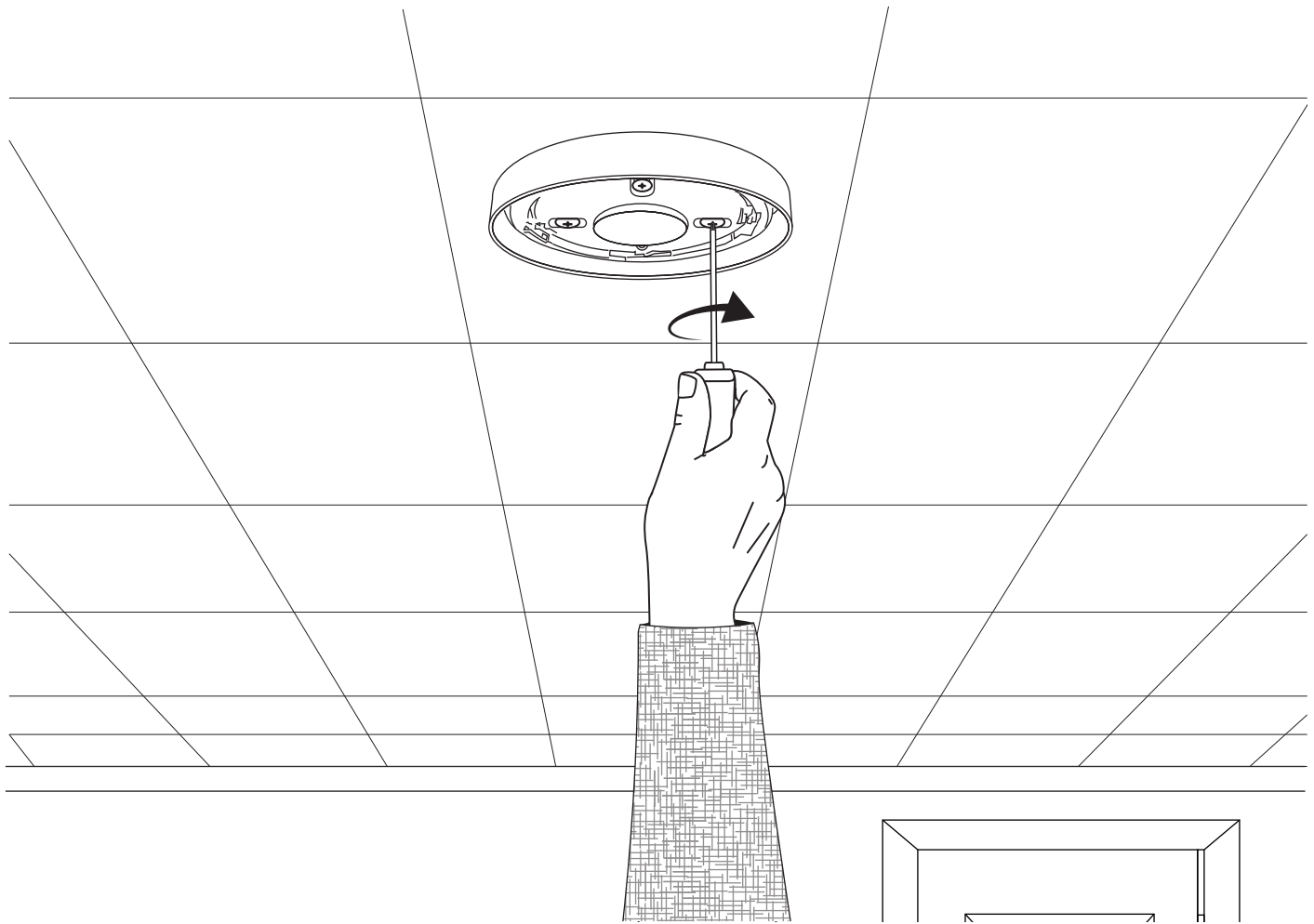

Note: Refer to the associated device installation guide for full details.

# Add devices to system

From access level 3 (*as previously shown on page 16*), press the  button until the screen displays:

```
View System Status
Maintenance/Test
Device Options
→WZM Settines
```

Press the  button and the screen will display:

```
→Add New Device
Remove Device
Edit Settines
Signal Level Test
```

Press the  button and the screen will display\*:



```
→At WZM
At Device Location
Confisure Devices
```

Press the  button and the screen will display:

```
Insert Batteries
Into Device
NOW
```

Insert the device's batteries and the screen will change to show:

```
Add Fire Device ?
Sounder Detector
ID:001234
√Add <Exit
```

Check that the device ident on-screen matches the device ident shown on the barcode label. Press  to confirm, or  to cancel. If accepted, the screen will display:

```
New FIRE
Device Added
ID:001234
Address 01
```

Followed by:

*Either continue adding new devices (by inserting batteries, or press  until the front screen is displayed.*

```
Add Another
Device ?
√Continue <Exit
```

\* Refer to the 'SmartCell Intelligent Wireless Zone Monitor Programming Guide' (MK067) for alternative programming methods.

# Device attributes

From access level 3 (as previously shown on page 16), press the  button until the screen displays:

```
View System Status
Maintenance/Test
→Device Options
WZM Settings ◊
```

Press the  button and the screen will display:



```
→Add New Device
Remove Device
Edit Settings
Signal Level Test ◊
```

Press the  button until the screen displays:

```
Add New Device
Remove Device
→Edit Settings
Signal Level Test ◊
```

Press the  button and the screen will display:

```
A01 ID:001234
Sounder Detector
ID:001234
Devices ◊ Change>
```

Press the  button until the device to configure is shown. Press the  button and the screen will display:

```
A03 ID:001236
Sounder Detector
Beacon ID:001236
Devices ◊ Change>
```

Press the  button and the screen will display:

```
→Text Description
Detection- Dual
Smoke Sen- Normal
Heat Sen- 58C Sc
```

Available options for each device type are shown overleaf.

| <b>Menu Selection</b>  | <b>Available options</b>  |
|--|---|
| Text Description   | Refer to the 'Device location text' section overleaf.   |
| Detection  | Detection selection of 'Dual' (smoke & heat), 'Smoke Only' or 'Heat Only'.  |
| Smoke Sen  | Smoke sensitivity selection of; 'Normal*†' and 'Normal + AVF'. The AVF option allows additional verification of the alarm condition before reporting. |
| Heat Sen   | Heat sensitivity selection of; '58 °C static*†', '58 °C rate of rise*', '72 °C static*', '72 °C rate of rise*'.<br>                                   |
| Sound Volume   | Allows device sounder levels of; 'High' or 'Low'.   |
| Self Sound   | When enabled, the device will sound upon local alarm detection, whilst wireless communication with the WZM is lost.                                   |
| Audio/Visual  | Allows device sounder and beacon selection of; sounder & beacon, sounder only and beacon only.  |
| O/P 1 OFF  | Choose to switch the device's 'Output 1' off, when either the 'silence' or 'reset' button is pressed.   |
| O/P 2 OFF  | Choose to switch the device's 'Output 2' off, when either the 'silence' or 'reset' button is pressed.   |

*\*Approved EN54 sensitivities      † Default dual sensitivities*

# Device location text

From access level 3 (as previously shown on page 16), press the  button until the screen displays:

```
View System Status
Maintenance/Test
*Device Options
WZM Settinas  ◊
```

Press the  button and the screen will display:



```
*Add New Device
Remove Device
Edit Settinas
Signal Level Test ◊
```

Press the  button until the screen displays:

```
Add New Device
Remove Device
*Edit Settinas
Signal Level Test ◊
```

Press the  button and the screen will display the first device logged on to the system:

```
A01          ID:001234
Sounder Detector
ID:001234
Devices◊      Change>
```

Press the  button to scroll through the devices until the required device is shown. Press the  button:

```
A02          ID:001235
Dual Detector
ID:001235
Devices◊      Change>
```

Press the  button and the screen will display:

```
*Text Description
Detection-      Dual
Smoke Sen-     Normal
Heat Sen-      58C S◊
```

Press the  button and the screen will display:









```
■Dual Detector
ID:001235

F1 ABC  F2 Delete
```

Refer to the 'Text entry' section overleaf.

# Text entry

The following buttons will be required to enter new text descriptions:

| Button  | Action  |
|---|---|
|                  | Moves the selected character through the alphabet (forwards), one character at a time.  |
|                  | Moves the selected character through the alphabet (backwards), one character at a time.   |
|                  | Moves the cursor (selected character) left, one character at a time.  |
|                | Moves the cursor (selected character) right, one character at a time.   |
| FUNCTION 1<br> | Used to toggle character entry format between; upper case, lower case and number.   |
| FUNCTION 2<br> | Provides a delete function; press for single character deletion, or press and hold to delete all text.  |
|                | Exits from the current screen. The user is asked whether to save the changes (  button for yes and  button for no). |

# Set the panel type

Default panel type is 'Conventional'. If the WZM is to be connected to an addressable type fire panel, follow the steps below:

From access level 3 (*as previously shown on page 16*), press the  button until the screen displays:

```
View System Status
Maintenance/Test
Device Options
+WZM Settings
```

Press the  button and the screen will display:

```
+Panel Type
Sounder Options
Device Indicator
```

Press the  button and the screen will display:

```
+Conventional ✓
Addressable
```

Press the  button and the screen will display:

```
Conventional ✓
+WZM Settings
```

Press the  button and the screen will display:

```
+Addressable Panel
Selected
```



# Sounder tones

The default fire tone is TONE 5. Available tones are shown overleaf. To change the fire tone, follow the steps below:

From access level 3 (as previously shown on page 16), press the  button until the screen displays:

```
View System Status
Maintenance/Test
Device Options
→M2M Settings
```

Press the  button and the screen will display:

```
→Panel Type
Sounder Options
Device Indicator
```

Press the  button until the screen displays:

```
Panel Type
→Sounder Options
Device Indicator
```

Press the  button and the screen will display:



```
→Default Tone Select
Sounder Duration
Sounder Activation
Pulsed Output
```

Press the  button and the screen will display the currently selected tone:

































```
→Fire Tone - 05
```

Press the  button and the screen will display:

```
970Hz - 630Hz, @1Hz
  7 7 7 7 7 7 7
05
Tone ◊ ✓ To Select
```

Press the  and  buttons to view the available tones and press the  button to select the required tone:

```
800Hz - 970Hz, @1Hz
  7 7 7 7 7 7 7
03
Tone ✓ To Select
```

| TONE | TONE TYPE   | TONE DESCRIPTION / APPLICATION                                 |
|------|---|--|
| 1.   |    | 970Hz  |
| 2.   |    | 800Hz/970Hz at 2Hz   |
| 3.   |    | 800Hz - 970Hz at 1Hz   |
| 4.   |    | 970Hz 1s OFF / 1s ON   |
| 5.   |    | 970Hz, 0.5s / 630Hz at 1 Hz <b>**Default fire tone**</b>       |
| 6.   |    | 554Hz, 0.1s / 440Hz, 0.4s (AFNOR NF S 32 001)                  |
| 7.   |    | 500 - 1200Hz, 3.5s / 0.5s OFF (NEN 2575:2000 Dutch slow whoop) |
| 8.   |    | 420Hz 0.6s ON / 0.6s OFF (Australia AS1670 Alert tone)         |
| 9.   |    | 1000 - 2500Hz, 0.5s/ 0.5s OFF x 3/1.5s OFF (AS1670 Evacuation) |
| 10.  |    | 550Hz / 440Hz at 0.5Hz   |
| 11.  |    | 970Hz, 0.5s ON / 0.5s OFF x 3 / 1.5s OFF (ISO 8201)            |
| 12.  |    | 2850Hz, 0.5s ON / 0.5s OFF x 3 / 1.5s OFF (ISO 8201)           |
| 13.  |    | 1200Hz - 500Hz at 1Hz (DIN 33 404)                             |
| 14.  |    | 400Hz  |
| 15.  |    | 550Hz, 0.7s / 1000Hz, 0.33s                                    |
| 16.  |  | 1500Hz - 2700Hz at 3Hz   |
| 17.  |  | 750Hz  |
| 18.  |  | 2400Hz   |
| 19.  |  | 660Hz  |
| 20.  |  | 660Hz 1.8s ON / 1.8s OFF                                       |
| 21.  |  | 660Hz 0.15s ON / 0.15s OFF                                     |
| 22.  |  | 510Hz, 0.2s / 610Hz, 0.2s                                      |
| 23.  |  | 800 / 1000Hz 0.5s each (1Hz)                                   |
| 24.  |  | 250Hz - 1200Hz at 12Hz   |
| 25.  |  | 500Hz - 1200Hz at 0.33Hz                                       |
| 26.  |  | 2400Hz - 2900Hz at 9Hz <b>**Default information tone**</b>     |
| 27.  |  | 2400Hz - 2900Hz at 3Hz   |
| 28.  |  | 500 - 1200Hz, 0.5s/ 0.5s OFF x 3/1.5s OFF ( AS1670 Evacuation) |
| 29.  |  | 800Hz - 970Hz at 9Hz   |
| 30.  |  | 800Hz - 970Hz at 3Hz   |
| 31.  |  | 800Hz, 0.25s ON / 1s OFF                                       |
| 32.  |  | 500Hz - 1200Hz, 3.75s / 0.25s OFF (AS2220)                     |

Note: Tones 1, 4, 5 and 7 are EN54-3 approved tones.

# Sounder duration

As default, wireless sounders will automatically switch off after 30 minutes to conserve battery life. For continuous uninterrupted operation (until switched off by the control panel), follow the steps below.

From access level 3 (*as previously shown on page 16*), press the  button until the screen displays:

```
View System Status
Maintenance/Test
Device Options
+WZM Settings
```

Press the  button and the screen will display:

```
+Panel Type
Sounder Options
Device Indicator
```

Press the  button until the screen will displays:

```
Panel Type
+Sounder Options
Device Indicator
```

Press the  button and the screen will display:

```
+Default Tone Select
Sounder Duration
Sounder Activation
Pulsed Output
```

Press the  button until the screen will displays:

```
Default Tone Select
+Sounder Duration
Sounder Activation
Pulsed Output
```

Press the  button and the screen will display:

```
+30 Mins Auto Off ✓
Continuous
```

Press the  button until the screen will displays:

```
30 Mins Auto Off ✓
+Continuous
```

Press the  button and the screen will display:

```
Sounder Duration
Set To
Continuous
```

# Sounder activation method

As default, wireless sounders will only operate upon activation of the WZM's fire input. For 'immediate mode', so that sounders also operate upon the activation of a wireless device, follow the steps below.

From access level 3 (*as previously shown on page 16*), press the  button until the screen displays:

```
View System Status
Maintenance/Test
Device Options
+WZM Settings
```

Press the  button and the screen will display:

```
+Panel Type
Sounder Options
Device Indicator
```

Press the  button until the screen will display:

```
Panel Type
+Sounder Options
Device Indicator
```

Press the  button and the screen will display:

```
+Default Tone Select
Sounder Duration
Sounder Activation
Pulsed Output
```

Press the  button until the screen will display:

```
Default Tone Select
Sounder Duration
+Sounder Activation
Pulsed Output
```

Press the  button and the screen will display:

```
+Panel Mode
Immediate Mode
```

Press the  button until the screen will display:

```
Panel Mode
+Immediate Mode
```

Press the  button and the screen will display:

```
Sounder Activation
Set To
Immediate Mode
```

# Pulsed output

As default the PULSED OUTPUT for the fire and the fault relays is set to latched. Upon an activation, the relay will remain latched in alarm until the WZM is reset. To alternatively pulse into alarm for a pre-defined period of time (range from 5-60 seconds) before automatically clearing, follow the steps below.

From access level 3 (as previously shown on page 16), press the  button until the screen displays:

```
View System Status
Maintenance/Test
Device Options
+WZM Settings
```

Press the  button and the screen will display:

```
+Panel Type
Sounder Options
Device Indicator
```

Press the  button until the screen will display:

```
Panel Type
+Sounder Options
Device Indicator
```

Press the  button and the screen will display:



```
+Default Tone Select
Sounder Duration
Sounder Activation
Pulsed Output
```

Press the  button until the screen will display:

```
Default Tone Select
Sounder Duration
Sounder Activation
+Pulsed Output
```

Press the  button and the screen will display:



```
+Fire Relay- LATCH
Fault Relay- LATCH
```

Press the  and  buttons, until the screen displays the required relay type: In this example, the fault relay has been chosen.

```
Fire Relay- LATCH
+Fault Relay- LATCH
```

Press the  button and the screen will display:

```
Fault Relay
00 LATCH
Secs ⬆ ⬇ ⬆ To Select
```

Press the  and  buttons, until the required time is displayed:  
In this example, 20 seconds has been chosen.

```
Fault Relay
20 Seconds
Secs ⬆ ⬇ ⬆ To Select
```

Press the  button and the screen will display:

```
Fire Relay- LATCH
→Fault Relay- 15
⬇
```

Note: the same options are available for the fire and fault relays.

# Device indicator operation

This feature is only available when the 'Panel Type' is set to 'Addressable'. As default, the device LED indicators are switched 'Off When Silenced' (upon receipt of a silence command signal from the control panel). Alternatively 'Off When Reset' can be selected (where the device LED indicators switch off upon the receipt of a reset command signal from the control panel, by following the steps below.

From access level 3 (*as previously shown on page 16*), press the  button until the screen displays:

```
View System Status
Maintenance/Test
Device Options
+M2M Settings
```

Press the  button and the screen will display:

```
+Panel Type
Sounder Options
Device Indicator
```

Press the  button until the screen will display:

```
Panel Type
Sounder Options
+Device Indicator
```

Press the  button and the screen will display:

```
+Off When Silenced ✓
Off When Reset
```

Press the  button until the screen will display:

```
Off When Silenced ✓
+Off When Reset
```

Press the  button and the screen will display:

```
Fire Status
Turned Off
When Reset
```

# Device signal levels

From access level 3 (as previously shown on page 16), press the  button until the screen displays:

```
View System Status
+Maintenance/Test
Device Options
WZM Settings
```

Press the  button and the screen will display:

```
+Sounder.O/P Test
Device Signal List
Device Battery List
Edit Service Code
```

Press the  button until the screen displays:



```
Sounder.O/P Test
+Device Signal List
Device Battery List
Edit Service Code
```

Press the  button and the screen will display:

```
+Good Signal      08
Low Signal        00
No Signal         00
More>
```

Press the  &  buttons to highlight the required signal category.

```
+Good Signal      08
Low Signal        00
No Signal         00
More>
```

Press the  button to select the required category and the device signals can be viewed, by pressing the  &  buttons.

```
Z01 A08          80dB
Dual Detector
First Floor Landings
GOOD Signal     
```



Note: It is important that all devices have GOOD signal levels to ensure the maximum robustness of wireless signalling.

If a device does not achieve a good signal level, for further guidance refer to the 'How to improve device signal levels' section within the SmartCell WZM Programming Guide (MK067).



# Test devices

Every device should be function tested, to ensure correct functionality.

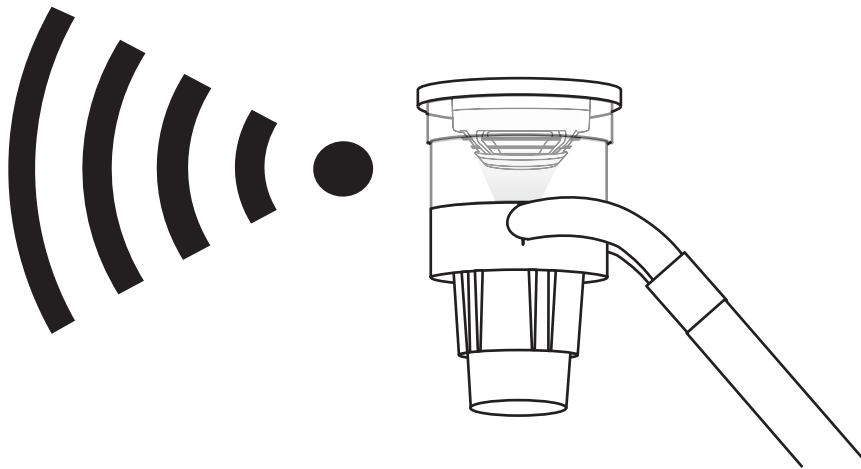

- Smoke detectors should be tested using a smoke detector tester and in accordance with local codes of practice.
- Heat detectors should be tested using a heat detector tester and in accordance with local codes of practice.
- Call Points should be tested in accordance with local codes of practice.
- Sounder operation should also be tested in accordance with local codes of practice.
- Input / Output devices should also be tested in conjunction with associated 3rd party equipment and in accordance with local codes of practice.

***See overleaf for additional WZM testing features.***

# Congratulations

Your SmartCell WZM should now be successfully installed.



# Notes

# SmartCell

[www.mysmartcell.co.uk](http://www.mysmartcell.co.uk)

The information contained within this literature is correct at time of publishing. EMS reserves the right to change any information regarding products as part of its continual development enhancing new technology and reliability. EMS advises that any product literature issue numbers are checked with its head office prior to any formal specification being written.