

iDS-2CD7026G0/P-AP 2 MP ANPR Box Network Camera

DarkFighter



▪ DeepinView^{series}

- High quality imaging with 2 MP resolution
- Excellent low-light performance via DarkFighter technology
- Clear imaging against strong back light due to 140 dB WDR technology
- License Plate Recognition
- Efficient H.265+ compression technology to save bandwidth and storage
- Advanced streaming technology enables smooth live view and data self-correction in poor networks
- 5 streams and up to 5 custom streams to meet a wide variety of applications
- Built-in microphone for real-time audio security



▪ Function

Road Traffic and Vehicle Detection

With embedded deep learning based license plate capture and recognition algorithms, the camera alone can achieve plate capture and recognition. The algorithm enjoys the high recognition accuracy of common plates and complex-structured plates, which is a great step forward comparing to traditional algorithms. Blocklist and allowlist are available for plate categorization and separate alarm triggering.

Smooth Streaming

Smooth streaming offers solutions to improve the video quality in different network conditions. For example, in poor network conditions, adapting to the detected real-time network condition, streaming bit rate and resolution are automatically adjusted to avoid mosaic and lower latency in live view; in multiplayer network conditions, the camera transmits the redundant data for the self-error correcting in back-end device, so that to solve the mosaic problem because of the packet loss and error rate.

▪ Specification

Camera	
Image Sensor	1/1.8" Progressive Scan CMOS
Min. Illumination	Color: 0.001 Lux @ (F1.2, AGC ON); B/W: 0.0003 Lux @ (F1.2, AGC ON)
Max. Resolution	1920 × 1080
Shutter Speed	1 s to 1/100,000 s
Day & Night	IR cut filter Blue glass module to reduce ghost phenomenon.
Lens	
Iris Type	P-iris
Aperture	Constant F1.2 throughout the zoom range
Lens Mount	CS mount
ABF	Yes
Video	
Main Stream	50 Hz: 50 fps (1920 × 1080, 1280 × 720) 60 Hz: 60 fps (1920 × 1080, 1280 × 720)
Sub Stream	50 Hz: 25 fps (704 × 576, 640 × 480) 60 Hz: 30 fps (704 × 480, 640 × 480)
Third Stream	50Hz: 25fps (1920 × 1080, 1280 × 720, 704 × 576, 640 × 480) 60Hz: 30fps (1920 × 1080, 1280 × 720, 704 × 480, 640 × 480)
Fourth Stream	50 Hz: 25 fps (1920 × 1080, 1280 × 720, 704 × 576, 640 × 480) 60 Hz: 30 fps (1920 × 1080, 1280 × 720, 704 × 480, 640 × 480)
Fifth Stream	50 Hz: 25 fps (704 × 576, 640 × 480) 60 Hz: 30 fps (704 × 480, 640 × 480)
Custom Stream	50 Hz: 25 fps (1920 × 1080, 1280 × 720, 704 × 576, 640 × 480) 60 Hz: 30 fps (1920 × 1080, 1280 × 720, 704 × 480, 640 × 480)
Video Compression	Main stream: H.265+/H.265/H.264+ / H.264 Sub-stream/Third stream/Fourth stream/Fifth stream/custom stream: H.265/H.264/MJPEG
Video Bit Rate	32 Kbps to 16 Mbps
H.264 Type	Baseline Profile/Main Profile/High Profile
H.265 Type	Main Profile
Bit Rate Control	CBR/VBR
Stream Type	Main stream/Sub-stream/third stream/fourth stream/fifth stream/custom stream
Scalable Video Coding (SVC)	H.265 and H.264 encoding
Region of Interest (ROI)	4 fixed regions for each stream
Audio	
Environment Noise Filtering	Yes
Audio Sampling Rate	8 kHz/16 kHz/32 kHz/44.1 kHz/48 kHz
Audio Compression	G.711/G.722.1/G.726/MP2L2/PCM/MP3
Audio Bit Rate	64K bps (G.711)/16 Kbps (G.722.1)/16 Kbps (G.726)/32 to 192 Kbps (MP2L2)/32 Kbps (PCM)/8 to 320 Kbps (MP3)
Audio Type	mono sound

Network	
Simultaneous Live View	Up to 20 channels
API	Open Network Video Interface (PROFILE S, PROFILE G, PROFILE T), ISAPI, SDK, ISUP
Protocols	TCP/IP, ICMP, HTTP, HTTPS, FTP, SFTP, SRTP, DHCP, DNS, DDNS, RTP, RTSP, RTCP, PPPoE, NTP, UPnP, SMTP, SNMP, IGMP, 802.1X, QoS, IPv6, UDP, Bonjour, SSL/TLS
Smooth Streaming	Yes
User/Host	Up to 32 users 3 user levels: administrator, operator and user
Security	Password protection, complicated password, HTTPS encryption, 802.1X authentication (EAP-TLS, EAP-LEAP, EAP-MD5), watermark, IP address filter, basic and digest authentication for HTTP/HTTPS, WSSE and digest authentication for Open Network Video Interface, RTP/RTSP OVER HTTPS, Control Timeout Settings, Security Audit Log, TLS 1.2
Network Storage	NAS (NFS, SMB/CIFS), auto network replenishment (ANR) Together with high-end Hikvision memory card, memory card encryption and health detection are supported.
Client	iVMS-4200, Hik-Connect, Hik-Central
Web Browser	Plug-in required live view: IE8+ Plug-in free live view: Chrome 57.0+, Firefox 52.0+, Safari 11+ Local service: Chrome 41.0+, Firefox 30.0+
Image	
Wide Dynamic Range (WDR)	140 dB
Day/Night Switch	Day, Night, Auto, Schedule, Triggered by Alarm In, Triggered by Video
Target Cropping	Yes
Picture Overlay	LOGO picture can be overlaid on video with 128 × 128 24bit bmp format
Image Enhancement	BLC, HLC, 3D DNR, Defog, EIS, Distortion Correction
Image Parameters Switch	Yes
Image Settings	Saturation, brightness, contrast, sharpness, gain, white balance adjustable by client software or web browser
SNR	≥ 52 dB
Interface	
Alarm	2 inputs, 2 outputs (max. 24 VDC, 1A)
Audio	1 input (line in), 1 output (line out), 3.5 mm connector, 2 channels, 1 built-in microphone
RS-485	1 RS-485 (half duplex, HIKVISION, Pelco-P, Pelco-D, self-adaptive)
Video Output	1 Vp-p Composite Output (75Ω/CVBS) (Only for debugging)
On-board Storage	Built-in memory card slot, support microSD/SDHC/SDXC/TF card, up to 256 GB
Hardware Reset	Yes
Communication Interface	1 RJ45 100 M/1000 M self-adaptive Ethernet port
Power Output	12 VDC, max. 100 mA (supported by all power supply types)
Event	
Basic Event	Motion detection, video tampering alarm, exception (network disconnected, IP address conflict, illegal login, HDD full, HDD error)

Smart Event	<p>Line crossing detection, up to 4 lines configurable</p> <p>Intrusion detection, up to 4 regions configurable</p> <p>Region entrance detection, up to 4 regions configurable</p> <p>Region exiting detection, up to 4 regions configurable</p> <p>Unattended baggage detection, up to 4 regions configurable</p> <p>Object removal detection, up to 4 regions configurable,</p> <p>Scene change detection, audio exception detection, defocus detection</p>
Counting	Yes
Deep Learning Function	
Premier Protection	<p>Line crossing, intrusion, region entrance, region exiting</p> <p>Support alarm triggering by specified target types (human and vehicle)</p> <p>Filtering out mistaken alarm caused by target types such as leaf, light, animal, and flag, etc.</p>
Road Traffic and Vehicle Detection	<p>Blocklist and allowlist: up to 10,000 records</p> <p>Captures vehicle that has no license plate</p> <p>Support license plate recognition of motorcycles (only in checkpoint scenario)</p> <p>Support vehicle attribute detection, including vehicle type, color, brand, etc. (City Street mode is recommended.)</p>
General	
Linkage Method	<p>Upload to FTP/NAS/memory card, notify surveillance center, send email, trigger alarm output, trigger recording, trigger capture</p> <p>Trigger recording: memory card, network storage, pre-record and post-record</p> <p>Trigger captured pictures uploading: FTP, SFTP, HTTP, NAS, Email</p> <p>Trigger notification: HTTP, ISAPI, alarm output, Email</p>
Online Upgrade	Yes
Dual Backup	Yes
Web Client Language	<p>33 languages</p> <p>English, Russian, Estonian, Bulgarian, Hungarian, Greek, German, Italian, Czech, Slovak, French, Polish, Dutch, Portuguese, Spanish, Romanian, Danish, Swedish, Norwegian, Finnish, Croatian, Slovenian, Serbian, Turkish, Korean, Traditional Chinese, Thai, Vietnamese, Japanese, Latvian, Lithuanian, Portuguese (Brazil), Ukrainian</p>
General Function	Anti-flicker, 5 streams and up to 5 custom streams, EPTZ, heartbeat, mirror, privacy masks, flash log, password reset via e-mail, pixel counter
Software Reset	Yes
Sustainability	Yes
Storage Conditions	-30 °C to 60 °C (-22 °F to 140 °F). Humidity 95% or less (non-condensing)
Startup and Operating Conditions	-30 °C to 60 °C (-22 °F to 140 °F). Humidity 95% or less (non-condensing)
Power Supply	12 VDC ± 24.9%, two-core terminal block, reverse polarity protection; 24 VAC ± 24.9%; PoE : 802.3af, Type 1, Class 3
Power Consumption and Current	With extra load: 12 VDC, 1 A, 24 VAC, 0.79 A, 50/60 Hz, 12 W; PoE (802.3af, 36 to 57 VDC), 0.34 to 0.21A, Class 3
Power Interface	Two-core terminal block
Camera Material	Aluminum alloy body
Screw Material	Mild steel

Camera Dimension	142.5 × 69.8 × 68 mm (5.61" × 2.75" × 2.68")
Package Dimension	315 × 140 × 140 mm (12.4" × 5.51" × 5.51")
Camera Weight	Approx. 730 g (1.96 lb.)
With Package Weight	Approx. 1115 g (2.99 lb.)
Metadata	
Metadata	Metadata of intrusion detection, line crossing detection, region entrance detection, region exiting detection, unattended baggage detection, object removal are supported.
Approval	
Class	Class B
EMC	FCC (47 CFR Part 15, Subpart B); CE-EMC (EN 55032: 2015, EN 61000-3-2:2019, EEN 61000-3-3:2013+A1:2019, EN 50130-4: 2011 +A1: 2014); RCM (AS/NZS CISPR 32: 2015); IC (ICES-003: Issue 7); KC (KN 32: 2015, KN 35: 2015)
Safety	UL (UL 62368-1); CB (IEC 62368-1:2014+A11); CE-LVD (EN 62368-1:2014/A11:2017); BIS (IS 13252(Part 1):2010/ IEC 60950-1 : 2005); LOA (IEC/EN 60950-1)
Environment	CE-RoHS (2011/65/EU); WEEE (2012/19/EU); Reach (Regulation (EC) No 1907/2006)

▪ Available Model

iDS-2CD7026G0/P-AP



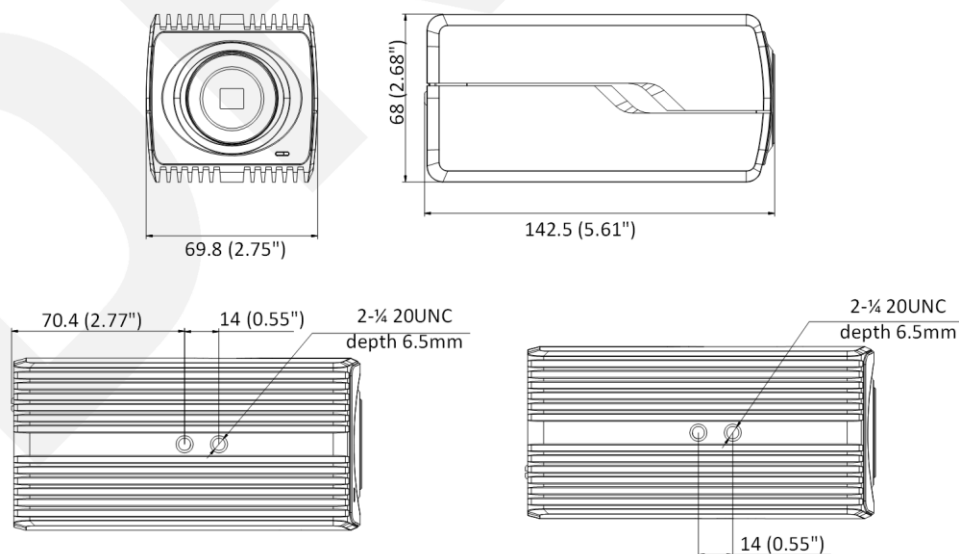











▪ Dimension



Unit: mm (inch)

▪ **Accessory**

▪ **Optional**

<p>DS-1269ZJ Pendant Mount</p> 	<p>DS-1332HZ Indoor Housing</p> 	<p>HV1140D-8MPIR Mega-pixel Auto-Iris Lens</p> 	<p>DS-2202ZJ Wall mount</p> 	<p>DS-1293ZJ Wall mount</p> 
<p>HV1140P-8MPIR Mega-pixel P-Iris Lens</p> 	<p>HV3816P-8MPIR Mega-pixel P-Iris Lens</p> 	<p>HV0415D-MP Mega-pixel Auto-Iris Lens</p> 	<p>DS-1233ZJ Pendant Mount</p> 	<p>DS-1299ZJ Pendant Mount</p> 
<p>DS-1292ZJ Wall mount</p> 	<p>HV0733D-6MP Mega-pixel Auto-Iris Lens</p> 	<p>HV3816D-8MPIR Mega-pixel Auto-Iris Lens</p> 	<p>DS-1331HZ-B Outdoor Housing</p> 	<p>DS-1214ZJ Horizontal pole mount</p> 

Distributed by

**HIKVISION®****Headquarters**

No.555 Qianmo Road, Binjiang District,
Hangzhou 310051, China
T +86-571-8807-5998
overseasbusiness@hikvision.com

Hikvision USA
T +1-909-895-0400
sales.usa@hikvision.com

Hikvision Australia
T +61-2-8599-4233
salesau@hikvision.com

Hikvision India
T +91-22-28469900
sales@pramahikvision.com

Hikvision Canada
T +1-866-200-6690
sales.canada@hikvision.com

Hikvision Thailand
T +662-275-9949
sales.thailand@hikvision.com

Hikvision Europe
T +31-23-5542770
sales.eu@hikvision.com

Hikvision Italy
T +39-0438-6902
info.it@hikvision.com

Hikvision Brazil
T +55 11 3318-0050
Latam.support@hikvision.com

Hikvision Turkey
T +90 (216)521 7070- 7074
sales.tr@hikvision.com

Hikvision Malaysia
T +601-7652-2413
sales.my@hikvision.com

Hikvision UK & Ireland
T +01628-902140
sales.uk@hikvision.com

Hikvision South Africa
Tel: +27 (10) 0351172
sale.africa@hikvision.com

Hikvision France
T +33(0)1-85-330-450
info.fr@hikvision.com

Hikvision Kazakhstan
T +7-727-9730667
nikia.panfilov@hikvision.ru

Hikvision Vietnam
T +84-974270888
sales.vt@hikvision.com

Hikvision UAE
T +971-4-4432090
salesme@hikvision.com

Hikvision Singapore
T +65-6684-4718
sg@hikvision.com

Hikvision Spain
T +34-91-737-16-55
info.es@hikvision.com

Hikvision Tashkent
T +99-87-1238-9438
uzb@hikvision.ru

Hikvision Hong Kong
T +852-2151-1761
info.hk@hikvision.com

Hikvision Russia
T +7-495-669-67-99
saleru@hikvision.com

Hikvision Korea
T +82-(0)31-731-8817
sales.korea@hikvision.com

Hikvision Poland
T +48-22-460-01-50
info.pl@hikvision.com

Hikvision Indonesia
T +62-21-2933759
Sales.Indonesia@hikvision.com

Hikvision Colombia
sales.colombia@hikvision.com